



Security Tech Germany



ABUS USA PRODUCT CATALOG

800.352.ABUS | abus.com



ABUS ADVANTAGES



SAME DAY SHIPPING

Stock orders received by 6 p.m. EST ship the same day!



LEADING PADLOCK MANUFACTURER

ABUS is the market-leading padlock manufacturer throughout the world

97

YEARS OF INNOVATIVE PRODUCTS

August Bremicker and his sons founded ABUS in 1924 in Volmarstein, Germany



ENGINEERED TO HIGHEST GLOBAL STANDARDS

ABUS products are German engineered and undergo a series of extensive tests to meet international standards. ABUS product quality is second to none.

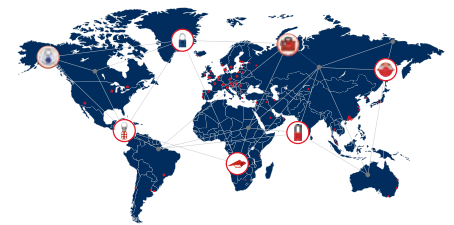

GLOBAL IMPACT

3,500+ Employees
25 Branch Offices



Security Tech Germany

IN-HOUSE LASER ENGRAVING



In-house engraving is fast and reliable – most orders ship in 5 business days



CHARTING & KEY STAMPING

Rely on ABUS to keep key code records for your facility

ABUS can provide locks to match an existing keyway in your facility

KEY INTO EXISTING SYSTEMS

US headquarters provide short lead times and fast delivery



ABUS USA ★ PHOENIX, ARIZONA
UNITED STATES HEADQUARTERS AND WAREHOUSE

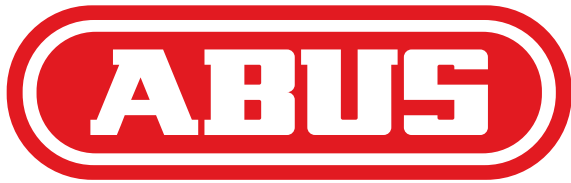

Security Tech Germany

CUSTOMER SUPPORT

Do you have a question concerning ABUS, but don't know who to contact? We're here to help, and you can contact us in the following ways:

- Call us at 800-352-ABUS to speak to a Customer Support representative from 7:00 a.m. to 4:00 p.m. Mountain Standard Time.
- Email us at customerservice@us.abus.com.
- Visit www.abus.com to learn more about ABUS products and services.

Safety Lockout 4
Safety Padlocks, Devices, Kits,
Toolboxes, Safety Centers, Boards,
Hasps, Labels

Security 46
Padlocks, Diskus®, Cable Locks,
KeyGarage™

Hasps 92
Integral Hasp, Security Hasps

Accessories 96
Chain, Security Cables, Floor and
Wall Anchors, File Cabinet Bars

General Information 102
Icon Glossary, Engraving Form, Key
Blanks, Product Index, Terms and
Conditions

FIND US @ABUSUSA!



SAFETY LOCKOUT

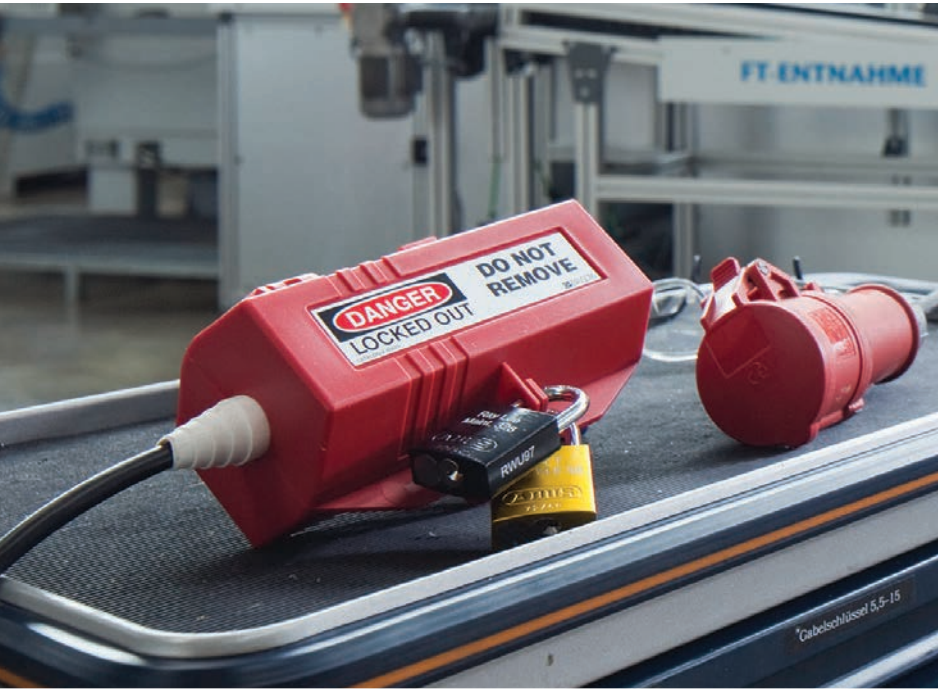



TOP OSHA VIOLATIONS



OSHA's Top 10 Frequently Cited Violations standards are released annually to alert employers about the most common hazards in the workplace. It is crucial for employers to implement safety plans with the right tools in order to prevent fatal accidents, injuries and illnesses. In addition, OSHA citations and fines can be costly.

ABUS carries a wide-range of lockout/tagout (LOTO) padlocks, devices and accessories that provide protection from hazardous energy. Users can customize padlocks through engraving and design custom kits.



KEY SYSTEMS

ABUS is experienced in creating comprehensive and intelligent keying systems based on user needs and requirements. We assist customers by designing large keying systems with multiple levels in which master keys or even grand master keys can be used to open all keyed-different or keyed-alike locks from different groups.

A locking system is a combination of different locking cylinders that have a certain relation to each other. Depending on what is needed, the functionalities of the cylinder can be bundled and exactly assigned. Within a locking system there are single keys, master keys and grand master keys – this makes it possible to distribute certain access rights among different employees.

Keyed Different:



Each padlock has its own unique key.

Keyed Alike:



Each padlock can be opened with the same key.

Keyed Different with Master Key:

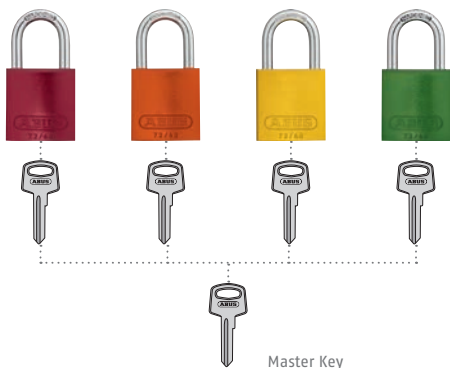

Each padlock has its own key. The master key can open all padlocks.

Keyed Different with Grand Master Key:

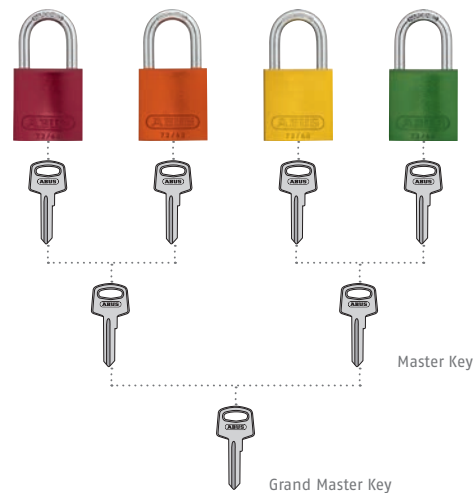

Each padlock has its own key. The padlocks of each group can be opened with their respective master key. All padlocks can be opened with the grand master key.



72 Series

The aluminum 72 Series padlocks provide a simple and secure solution for lockout/tagout applications. The lightweight, anodized aluminum body offers superior chemical and corrosion resistance. With a variety of sizes and shackle options, the 72 Series works in most industrial applications and is ideal for laser engraving.

ALUMINUM 72

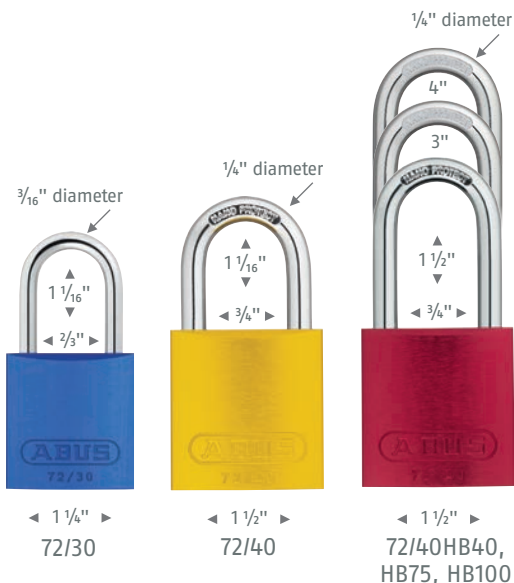

- Lightweight, anodized aluminum lock body offers superior chemical and corrosion resistance and is ideal for laser engraving
- NANO PROTECT™-coated hardened steel shackle provides superior corrosion resistance and is available in multiple shackle heights
- Meets OSHA lockout/tagout guidelines
- Available keyed-different, keyed-alike or master-keyed



Item	Body Width	Horizontal Shackle Clearance	Vertical Shackle Clearance	Shackle Diameter	Pins in Cylinder	Key Options	Case Pk Quantity
72/30	1 1/4"	2/5"	1 1/16"	3/16"	5	KA, KD, MK, GMK	6
72/40	1 1/2"	3/4"	1 1/16"	1/4"	6	KA, KD, MK, GMK	6
72/40HB40	1 1/2"	3/4"	1 1/2"	1/4"	6	KA, KD, MK, GMK	6
72/40HB75	1 1/2"	3/4"	3"	1/4"	6	KA, KD, MK, GMK	6
72/40HB100	1 1/2"	3/4"	4"	1/4"	6	KA, KD, MK, GMK	6

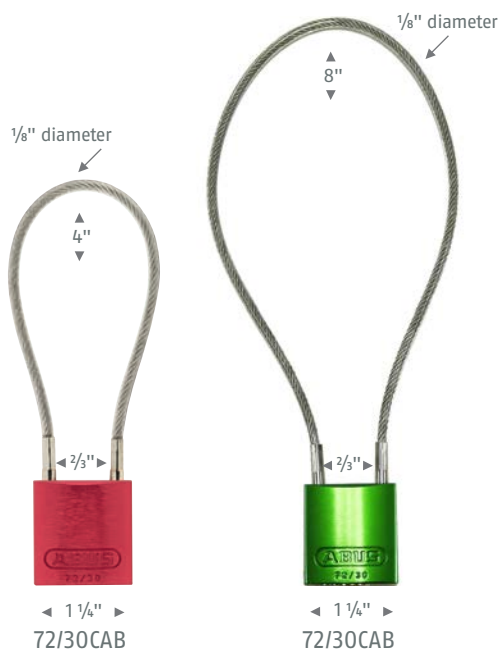

CABLE ALUMINUM 72

- Lightweight, anodized aluminum lock body offers superior chemical and corrosion resistance
- Highly flexible cable in two sizes for multi-purpose security solutions
- Laser engraving available for easy identifications
- Meets OSHA Lockout/Tagout Guidelines



Item	Body Width	Horizontal Cable Clearance	Vertical Cable Clearance	Cable Diameter	Pins in Cylinder	Key Options	Case Pk Quantity
72/30CAB	1 1/4"	2/5"	4"	1/8"	5	KA, KD, MK, GMK	6
72/30CAB	1 1/4"	2/5"	8"	1/8"	5	KA, KD, MK, GMK	6



74 Series

The 74 Series nylon-covered safety padlocks are completely insulated with electric shock, non-magnetic and non-sparking features. Ideal for temperamental environments and confined-space applications. The solid aluminum body is encased by a colored nylon cover for easy identification.

INSULATED 74

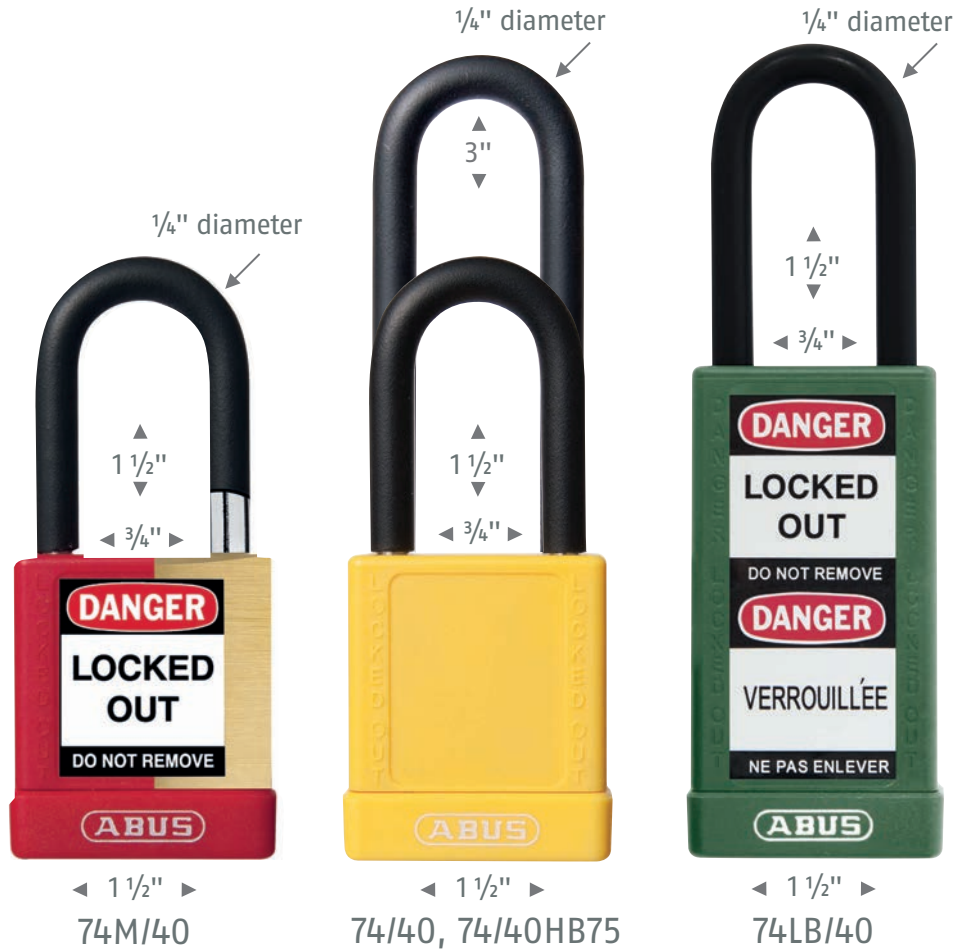

- 6-pin cylinder offers maximum number of key differs and is key-retaining
- Nylon-covered lock body and shackle are non-magnetic and dielectric, providing intrinsically safe protection
- Under the nylon casing, the NANO PROTECT™-coated steel shackle and aluminum or brass lock body are robust and chemical resistant
- All brass lock body available (74M) for extreme corrosion resistance
- Aluminum locks contain 70% recycled materials. All 74 series locks are produced in a facility achieving zero waste to landfill operations at a 98% diversion rate
- Ships with LOTO labels in English, Spanish and French
- Meets OSHA Lockout/Tagout Guidelines
- Comes key-retaining and is available keyed-different, keyed-alike or master-keyed



Item	Body Width	Horizontal Shackle Clearance	Vertical Shackle Clearance	Shackle Diameter	Pins in Cylinder	Key Options	Case Pk Quantity
74/40	1 1/2"	3/4"	1 1/2"	1/4"	6	KA, KD, MK, GMK	6
74/40HB75	1 1/2"	3/4"	3"	1/4"	6	KA, KD, MK, GMK	6
74LB/40	1 1/2"	3/4"	1 1/2"	1/4"	6	KA, KD, MK, GMK	6
74M/40	1 1/2"	3/4"	1 1/2"	1/4"	6	KA, KD, MK, GMK	6
74M/40HB75	1 1/2"	3/4"	3"	1/4"	6	KA, KD, MK, GMK	6
74MLB/40	1 1/2"	3/4"	1 1/2"	1/4"	6	KA, KD, MK, GMK	6



76 Series

The ABUS 76 Series is the first safety padlock to offer more than 200,000 true key differs with its 8-pin cylinder. The protected keyway eliminates cross-keying and reduces risk of employee injury, company liability and code violations. Available in a variety of colors and shackle options.

HIGH SECURITY 76

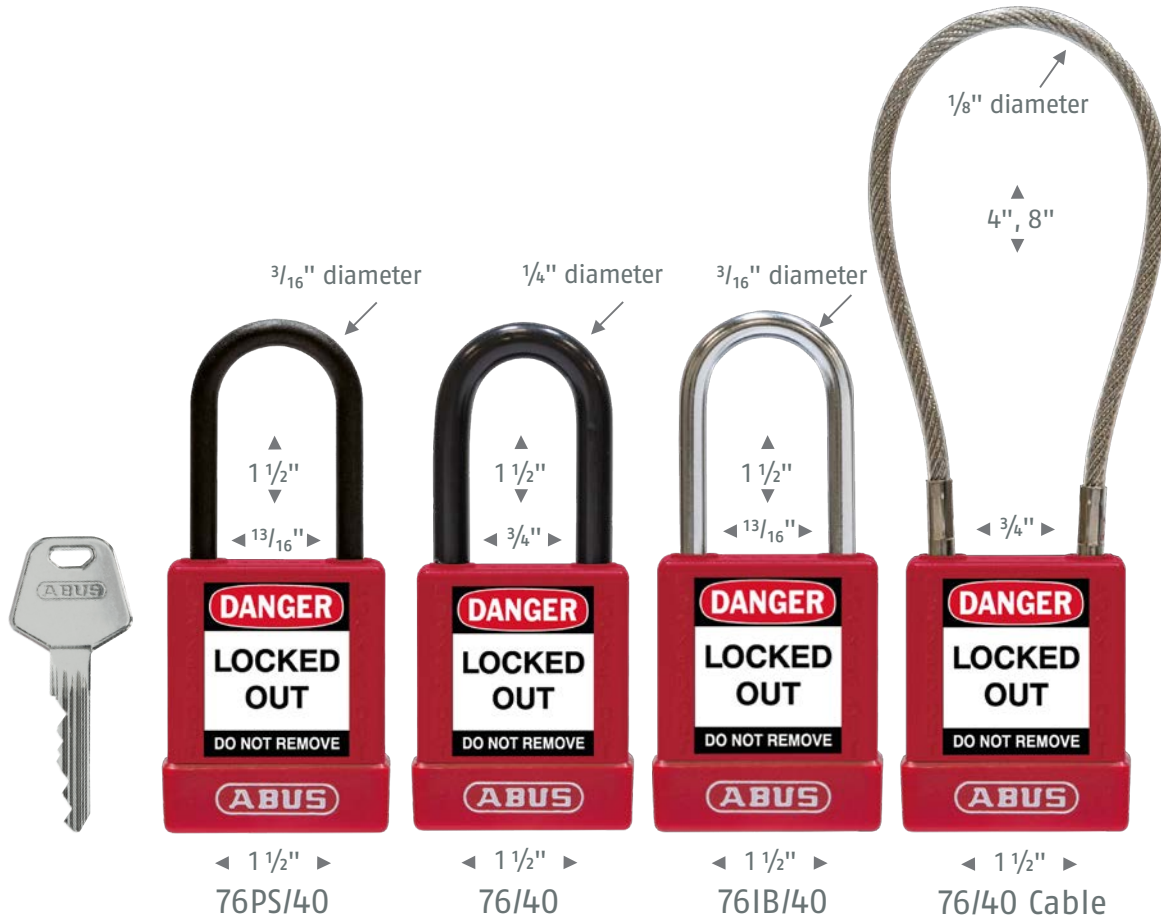

- 8-pin cylinder offers more than 200,000 key differs and up to 30,000 real guaranteed key differs under a master key
- Solid aluminum lock body encased by a colored nylon cover
- Robust lock body can endure harsh environments and is corrosion resistant
- Protected keyway eliminates cross-keying and reduces risk for employees
- Variety of shackle options: steel, stainless steel, plastic and sheathed steel cable shackle
- Improved key durability for increased breaking and torsion resistance
- Meets OSHA Lockout/Tagout Guidelines



Item	Body Width	Horizontal Shackle Clearance	Vertical Shackle Clearance	Shackle Diameter	Shackle Material	Pins in Cylinder	Key Options	Case Pk Quantity
76PS/40	1 1/2"	13/16"	1 1/2"	3/16"	Plastic	8	KA, KD, MK, GMK	6
76/40	1 1/2"	3/4"	1 1/2"	1/4"	Steel with Nylon Sleeve	8	KA, KD, MK, GMK	6
76/40HB75	1 1/2"	3/4"	3"	1/4"	Steel with Nylon Sleeve	8	KA, KD, MK, GMK	6
76IB/40	1 1/2"	13/16"	1 1/2"	3/16"	Stainless	8	KA, KD, MK, GMK	6
76IB/40HB75	1 1/2"	13/16"	3"	3/16"	Stainless	8	KA, KD, MK, GMK	6
76/40CAB 4"	1 1/2"	3/4"	4"	1/8"	Cable	8	KA, KD, MK, GMK	6
76/40CAB 8"	1 1/2"	3/4"	8"	1/8"	Cable	8	KA, KD, MK, GMK	6

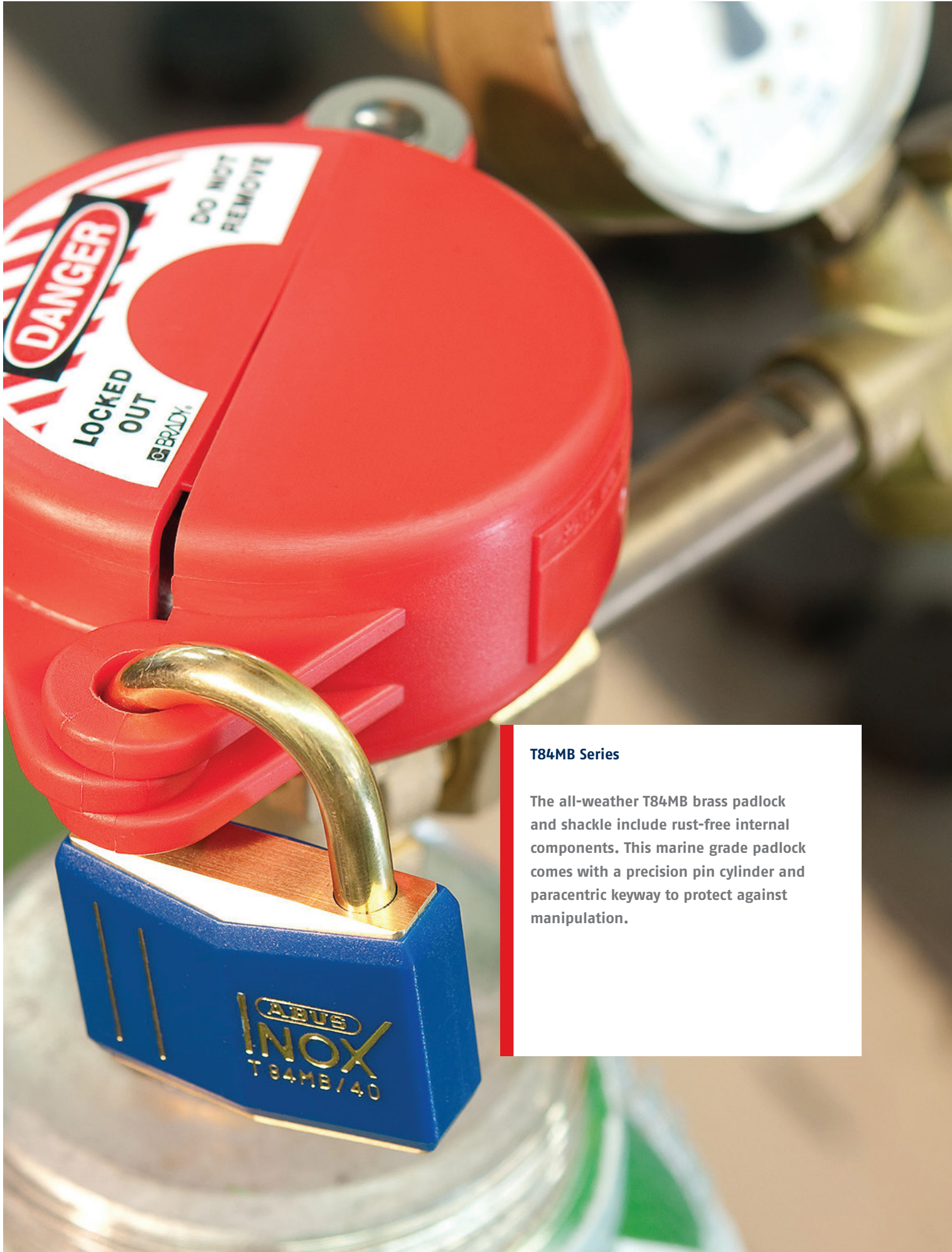

T84MB Series

The all-weather T84MB brass padlock and shackle include rust-free internal components. This marine grade padlock comes with a precision pin cylinder and paracentric keyway to protect against manipulation.

BRASS T84MB



- Shackle and body made from solid brass
- Inner components made from non-corrosive materials
- Precision pin tumbler
- Plastic casing available in 6 different colors
- Available keyed-different, keyed-alike or master-keyed



Item	Body Width	Horizontal Shackle Clearance	Vertical Shackle Clearance	Shackle Diameter	Pins in Cylinder	Key Options	Case Pk Quantity
T84MB/30*	1 1/4"	9/16"	9/16"	3/16"	3	KA, KD, MK	12
T84MB/40	1 11/16"	1"	13/16"	1/4"	4	KA, KD, MK	12
T84MB/50*	2"	1"	15/16"	5/16"	5	KA, KD, MK	6

*Available only with black jacket.



Lockout/Tagout Hasps

ABUS lockout hasps are ideal for group lockout applications. Main power switches and energy sources can easily be locked out during maintenance or service work with safety hasps. This is an easy and effective way to avoid accidental restarting of the machine.

LOCKOUT/TAGOUT HASPS



- Holds up to 6 padlocks
- Available with or without pry-resistant interlocking tabs for added security
- Made of vinyl-coated recycled steel
- 1" or 1 1/2" closed hole available



Item	Part Number	Opening Diameter	Holds #Locks	Material	Tabs	Case Pk Quantity
ST0701	93101A	1"	6	Recycled Steel	No	1
ST0702	93201B	1 1/2"	6	Recycled Steel	No	1
ST0801	93101	1"	6	Recycled Steel	Yes	1
ST0802	93201	1 1/2"	6	Recycled Steel	Yes	1

ALUMINUM LOCKOUT/TAGOUT HASPS

- Holds up to 6 padlocks
- Made of light weight, spark-resistant aluminum
- 1" or 1½" closed hole available



Item	Part Number	Opening Diameter	Holds #Locks	Material	Tabs	Case Pk Quantity
AL0701	00302	1"	6	Aluminum	No	1
AL0702	00340	1 ½"	6	Aluminum	No	1

PLASTIC LOCKOUT/TAGOUT HASPS

- Holds up to 6 padlocks
- Made of non-conductive, orange nylon



H770



Item	Part Number	Opening Diameter	Holds #Locks	Material	Tabs	Case Pk Quantity
H770	00346	1"	6	Nylon	No	1

BUTTERFLY LOCKOUT HASP

- Made of steel for strength and durability
- Anti-rust galvanized treatment for corrosion resistance

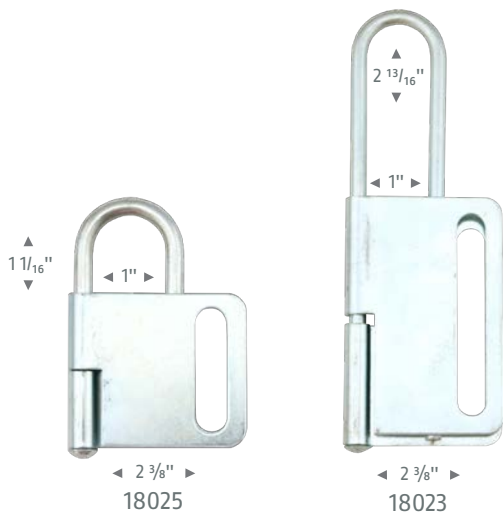

Part Number	Opening Diameter	Holds #Locks	Material	Tabs	Case Pk Quantity
18025	1"	6	Steel	No	1
18023	1"	10	Steel	No	1

ALUMINUM LABELED HASP

- Red labeled hasp for multiple workers
- Integrates traditional buckle and label into one unit
- Reusable write-on labels on both sides
- Made of aluminum alloy
- Available in English and Spanish



Part Number	Opening Diameter	Holds #Locks	Material	Tabs	Label Language	Case Pk Quantity
18024	1"	8	Aluminum	Yes	English	1
18034	1"	8	Aluminum	Yes	Spanish	1



Safety Redbox™

Maintenance on big machinery is usually an organizational effort. Many different access points have to be locked out among multiple workers. The Safety Redbox™ is lightweight and can be carried around or mounted to the wall with the included bracket.

SAFETY REDBOX™



- Made of powder-coated steel for extra corrosion protection in industrial settings
- Lid features secure locking mechanism to prevent accidental opening
- Patented lockable wall bracket to prevent unauthorized box movement
- Convenient ergonomic carrying handle for easy portability



Item	Part Number	Diameter of Holes	Holds #Locks	Material	Case Pk Quantity
B835 RED	00298	1/4"	12	Recycled Steel	1



Permit Redbox™

The B810 Permit Redbox™ incorporates permit-to-work procedures and a group lockout box in one unit. Having the necessary locks and permits stored together prevents miscommunication and ensures worker safety.

PERMIT REDBOX™



- Incorporates permit-to-work procedures and group lockout box in one unit
- Holds up to 20 padlocks
- Made of powder-coated steel to endure harsh settings
- Enclosed wall-bracket makes the box suitable for stationary and mobile use



Item	Part Number	Holds #Locks	Material	Case Pk Quantity
B810	88882	20	Powder-coated steel	1



Cable Lockouts

Cable lockout devices are universally applicable, especially in cases where longer distances between two lockout points have to be bridged. These flexible cables are available in different lengths.

SAFELEX™ CABLE LOCKOUT

- Sheathed steel cable with clear plastic coating available in 3', 6', 9' or 15' lengths
- Intuitive design for simple installation
- Patented grip mechanism for secure fixation of cable
- Retighten at any time, even when in locked position
- Holds up to 6 padlocks

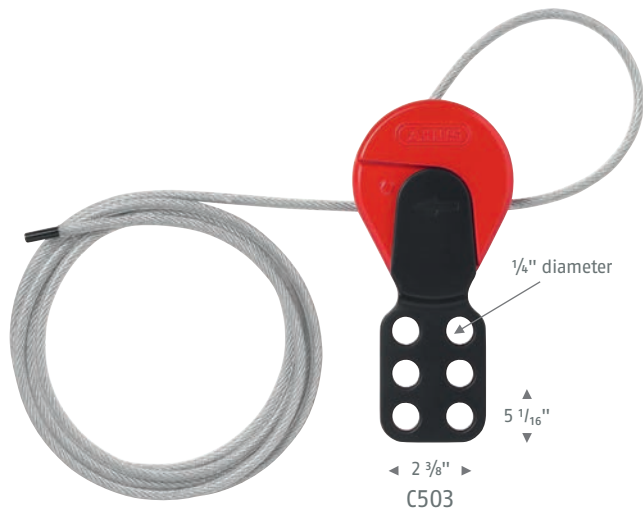

Item	Part Number	Cable Length	Cable Diameter	Holds #Locks	Case Pk Quantity
C503	00347	3'	1/8"	6	12
C506	00348	6'	1/8"	6	12
C509	00349	9'	1/8"	6	12
C515	00353	15'	1/8"	6	10

STANDARD CABLE LOCKOUT

- Sheathed steel cable with clear plastic coating available in 3', 6', 9' or 15' lengths
- Intuitive design for simple installation
- Holds up to 6 padlocks



Item	Part Number	Cable Length	Cable Diameter	Holds #Locks	Case Pk Quantity
C553	00355	3'	1/8"	6	8
C556	00356	6'	1/8"	6	8
C559	00359	9'	1/8"	6	12
C565	00361	15'	1/8"	6	10



Valve Lockout Devices

ABUS has a wide variety of valve devices that are designed to isolate energy which can protect workers from pressured valves during repairs and maintenance. Available in multiple sizes and materials to fit specific valves.

V500 UNIVERSAL VALVE LOCKOUT



- For virtually all handle sizes and shapes
- Creates a mounting point on the handle which is secured against a counterpoint using a cable lockout
- Large, specially shaped contact surface (rubberized on one side) for the ideal valve handle grip
- Large, stable metal housing



Item	Part Number	Holds #Locks	Material	Case Pk Quantity
V500	87151	2	Metal	1

METAL BALL VALVE LOCKOUT

- Stable and secure, made from powder-coated steel
- Two sizes for most common ball valves
- Various holes for exact positioning of padlock gives stability
- Best used on hard-to-reach pipes

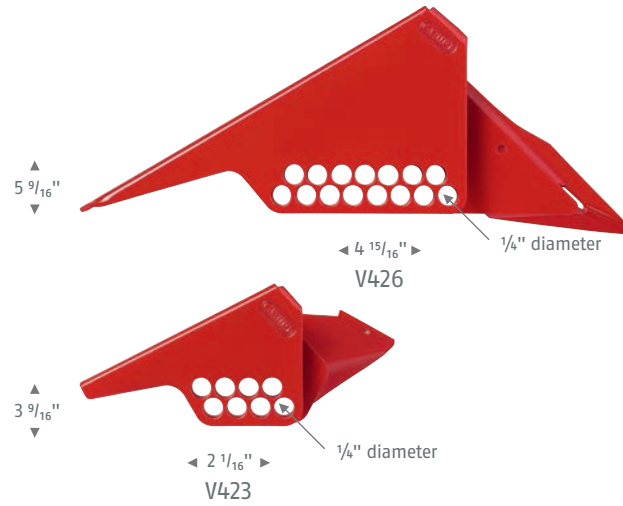

Item	Part Number	Holds #Locks	Max Handle Thickness	Max Handle Width	Case Pk Quantity
V423	00299	1	1/4"	1 7/16"	1
V426	00300	1	3/8"	2"	1

PLASTIC BALL VALVE LOCKOUT

- Made from high-quality polypropylene; long-lasting and non-conductive
- Two sizes: Fits ball valves from 1/2" to 8"
- Well-positioned padlock holes for better grip on the valve
- Holds 1 padlock

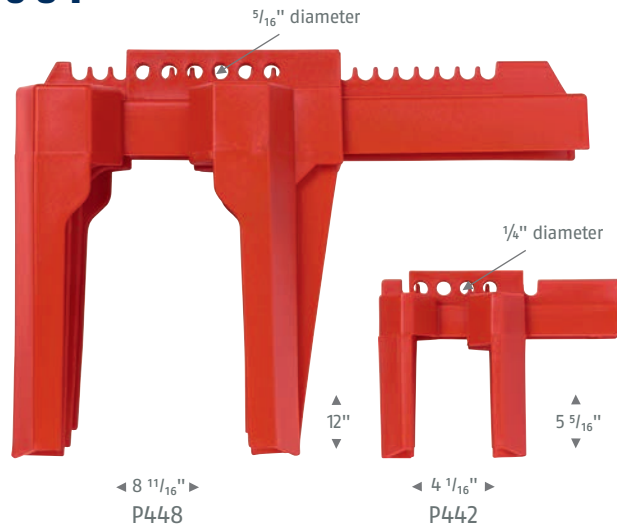

Item	Part Number	Holds #Locks	Max Handle Thickness	Max Handle Width	Case Pk Quantity
V442	00452	1	3/8"	7/8"	1
V448	00453	1	15/16"	1 11/16"	1

GATE VALVE LOCKOUT



- Made from high-quality polypropylene: long-lasting and non-conductive
- Five sizes: Fits gate valves from 1" to 13"
- Holds 1 padlock with up to 3/8" shackle diameter

- Predetermined breaking point at the top for threaded valves
- Stickers in various languages included

Item	Part Number	Holds #Locks	Fits Gate Valve Size	Case Pk Quantity
V303	00362	1	1 - 2 1/2"	1
V305	00364	1	2 1/2 - 5"	1
V307	00365	1	5 - 6 1/2"	1
V310	00366	1	6 1/2 - 10"	1
V313	00367	1	10 - 13"	1

GAS CYLINDER LOCKOUT

- Made from high-quality polypropylene: long-lasting, robust and non-conductive
- Warning sticker included
- Holds 1 padlock with up to 3/8" shackle diameter

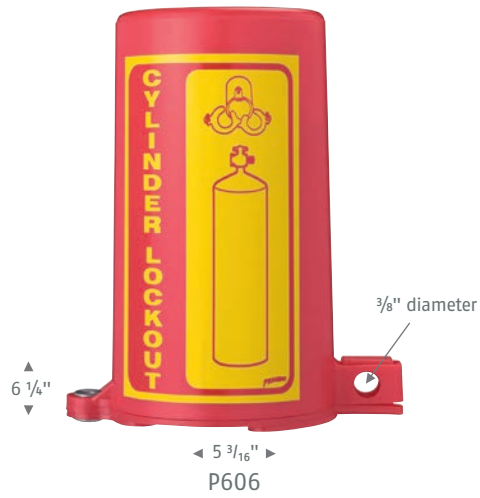

Item	Part Number	Holds #Locks	Inside Height	Inside Diameter	Case Pk Quantity
P606	00449	1	5 7/16"	3 1/16"	1

COMPRESSED AIR LOCKOUT

- Made from fiber-glass reinforced nylon: long-lasting, robust and non-conductive
- 3 different connections for most common compressed air couplings with 9/16" outside diameter
- The hole in the middle can be used to attach and store the lockout device directly at the connection
- Holds 1 padlock with 1/4" and 1 padlock with 1/4" shackle diameter per connection

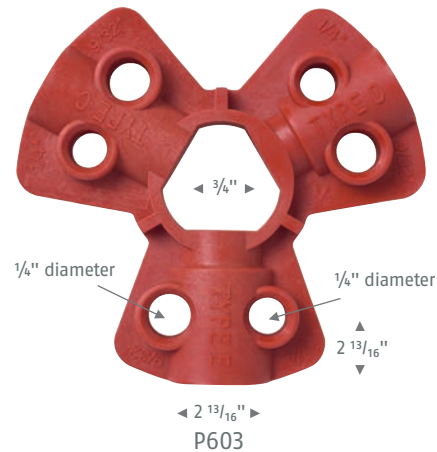

Item	Part Number	Holds #Locks	Case Pk Quantity
P603	00454	6	1

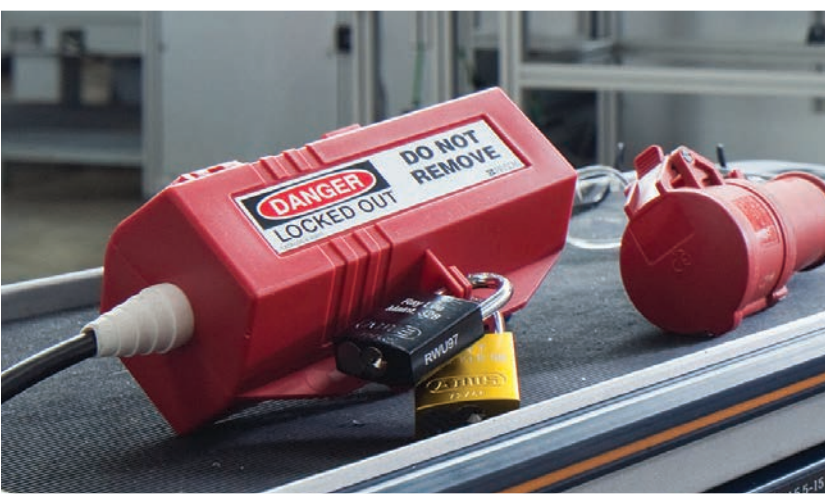



ULC100 Water Fountain Lockout

The ULC 100 Water Fountain Lockout Device is designed to lockout water fountain spouts for safety measures. Made of high-quality material, the tamper resistant, drawstring bag works on virtually every fountain type. Installation requires no tools and can be locked out with an ABUS padlock.

WATER FOUNTAIN LOCKOUT



- Drawstring cinch bag made of high quality, durable polyester material for repeated use
- Universal bag design works on all brands, makes and models of water fountains
- Keeps bottle filling station operational while the spout is locked out
- Secure plug valves and water fountain spouts with a stem diameter ranging from 3/4" to 2 1/2"
- Easy to install – no tools required
- Accommodates padlocks with shackle thickness up to 1/4"
- Imprint clearly identifies fountain cannot be used when installed
- Lightweight, foldable bag takes up minimal space on maintenance carts
- Tamper resistant

Item	Part Number	Holds #Locks	Material	Case Pk Quantity
ULC100	18099	1	Polyester	1



Circuit Breaker Lockout Devices

Electrical systems require safety lockout devices to properly shut down and prevent accidents. Lockout and isolate electrical equipment with the range of ABUS circuit breaker lockout devices.

SINGLE-POLE CIRCUIT BREAKER LOCKOUT

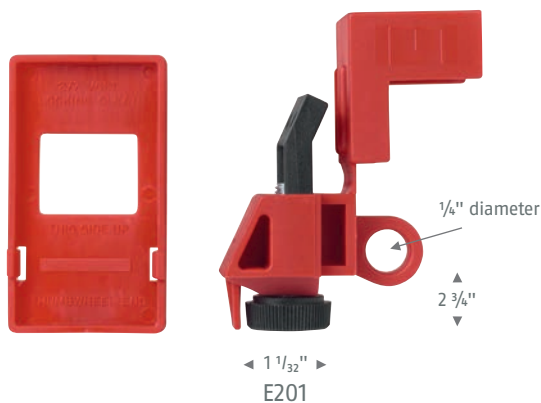

- Made from high-quality materials: long-lasting, robust and non-conductive
- Easy-to-use with screwing mechanism for secure fixation
- Can be used on common single-pole circuit breakers
- Comes with adapter for blade-type electric fuses
- Holds 1 padlock
- Voltage 120/277

Item	Part Number	Holds #Locks	Max. Width of Circuit Breaker	Case Pk Quantity
E201	00368	1	5/8"	1

MULTI-POLE CIRCUIT BREAKER LOCKOUT



- Made from high-quality materials: long-lasting, robust and non-conductive
- Easy-to-use with screwing mechanism for secure fixation
- Holds up to 2 padlocks with a shackle diameter up to 1/4"
- Can be used on common multi-pole circuit breakers that employ a tie bar
- Voltage 120/277

Item	Part Number	Holds #Locks	Max. Thickness of Bond Bridge	Case Pk Quantity
E202	00401	2	3/8"	1

POWER PLUG LOCKOUT

- Made from high-quality polypropylene: long-lasting, robust and non-conductive
- 2 Sizes: For standard plugs or high-voltage plugs
- Cable tunnel on both sides to secure plug connections
- Warning stickers in different languages included
- Holds up to 4 padlocks with a shackle diameter up to 3/8"

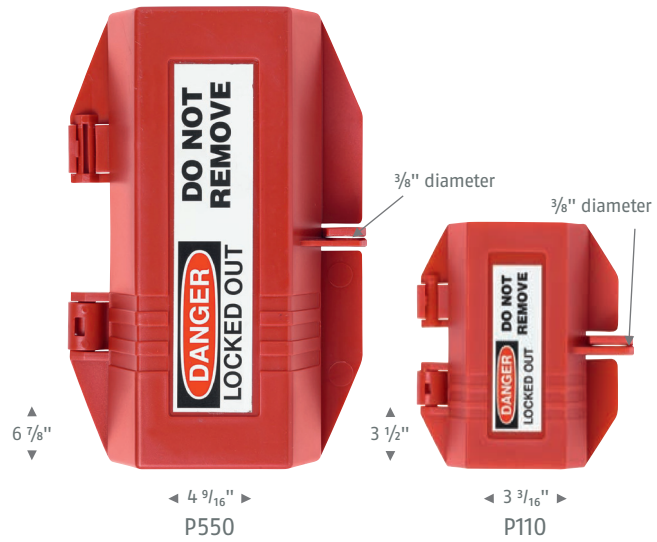

Item	Part Number	Holds #Locks	Warning Sticker Languages	Case Pk Quantity
P110	00450	2	English, Spanish, French	1
P550	00451	4	English, Spanish, French	1

UNIVERSAL FORKLIFT/PLUG LOCKOUT

- Lockout for plug, forklift, and gas cylinder
- Plug Lockouts: 120 volt plug, 250 volt-sp plug, 15-50 Amp 3P plug
- Forklift Lockouts:
 - Electric Driver Forklifts: Battery plug 50-250 Amp, starter battery negative (-) terminal
 - Propane Driver Forklifts: LP gas cylinder shutoff valve, LP gas tank coupling



Part Number	Holds #Locks	Case Pk Quantity
00457	6	1



PLUG AND HOIST LOCKOUT

- Locks out industrial control panels or large plug fittings or connectors
- Drawstring cinch bag made of durable polyester material
- Flexible, water-repellent and resistant to heat and dirt
- Insert PVC tubing to block access

Item	Part Number	Holds #Locks	Case Pk Quantity
P625	86525	1	1

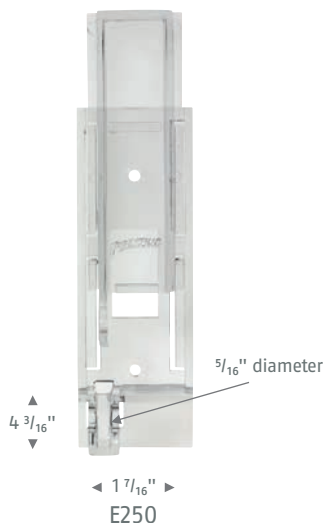

WALL SWITCH LOCKOUT

- Made from high-quality polycarbonate housing: long-lasting and robust
- Easy installation: Remove the screws from the wall switch plate and use them to mount the device onto the plate
- Sliding mechanism makes the device very easy to use
- Offers extra durability with hinge-less design
- Holds 1 padlock with up to 5/16" shackle diameter

Item	Part Number	Holds #Locks	Case Pk Quantity
E250	00406	1	1

PANEL HANDLE LOCKOUT

- Prohibits the movement of handles or levers on electrical panels
- Nylon base and a flexible stainless steel strip with 20 holes prevents handle from moving once locked with a lockout padlock
- Recommended for all handles and levers that do not have a built-in lockout arrangement
- Accommodates 1 padlock, with shackles up to 1/4"



Part Number	Holds #Locks	Case Pk Quantity
00456	1	1

PUSH BUTTON LOCKOUT

- Provides a lockout solution for oversize electrical push buttons on electrical panels or controls stations
- Can also be used on heavy machinery
- Installs in seconds
- Made from durable plastic (acrylic)
- Accommodates 1 padlock with a maximum shackle diameter of 1/4"



Part Number	Holds #Locks	Case Pk Quantity
00455	1	1

LOCKOUT TAGS



- Prevent accidental or unexpected start-up or release of stored energy when working on equipment or machinery
- Laminated vinyl with grommet and matte surface to withstand moisture
- Available tag types: DO NOT OPERATE; OUT OF SERVICE

Item	Part Number	Tag Material	Tag Text	Case Pk Quantity
T100	73004	Laminated Vinyl	DO NOT OPERATE	10
T102	73011	Laminated Vinyl	OUT OF SERVICE	10

LOCKOUT LABELS

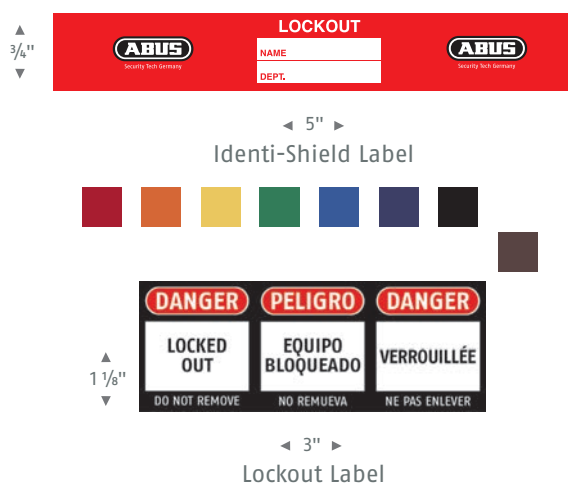

- Identi-shield labels: vinyl labels to add custom color and identification to standard padlocks
- Lockout labels: vinyl labels in multiple languages for lockout padlocks

Item	Label Material	Case Pk Quantity
Identi-Shield Label	Vinyl	1
Lockout Label (74/40 and 74/40HB75)	Vinyl	1
Lockout Label (74LB/40)	Vinyl	1



Tags on a Roll

Tags-On-A-Roll provide ease and convenience for safety tag storage. Ready for use, the roll dispenser provides easy access to the tags. Available in a variety of tag designs and languages.

TAGS ON A ROLL



Tags on a Roll

- Portable box made of corrugated cardboard keeps tags clean and ready to use
- Box features center hole for mounting
- Tags made of water-resistant printable .010" polyester. 5 versions available in quantities of 100 or 250
- Perforated for easy separation
- Tags measure 6 1/4" x 3", with 3/8" hole (fasteners sold separately)



Item	Part Number	Tag Quantity	Case Pk Quantity
Do Not Operate - Red	18184	100	1
Do Not Operate - Red	18185	250	1
Locked Out - Red	18188	100	1
Locked Out - Red	18189	250	1
Do Not Operate - White	18186	100	1
Do Not Operate - White	18187	250	1
Do Not Operate - White Eng/Spa	18190	100	1
Do Not Operate - White Eng/Spa	18191	250	1
Do Not Operate - White Eng/Fre	18192	100	1
Do Not Operate - White Eng/Fre	18193	250	1

CUSTOM SAFETY KITS

Build a custom kit that is modified to meet your facility needs.

ABUS Custom Kits allow you to select the devices and padlocks your facility requires to ensure your LOTO program operates smoothly.

Whether you need one or more ABUS Custom Kits, you have the flexibility of ordering your personalized kit frequently or building additional kits contingent on your LOTO program.



SELECT
Choose the pouch/toolbox, padlocks & devices you would like in your customized kit.



BUILD
We build your kit to fit the product you selected.



DELIVER
We ensure customized kits are delivered to your facility on time.



REORDER
We keep record of what each kit includes so reordering is quick and easy.

Locks	Cable LO	Gate Valve LO	Forklift/Plug LO	Panel Handle LO	Tags
 72 Aluminum	 C503-C515	 V303	 00457	 00456	 T100
 74 Insulated	 C553-C565	 V305	 E250	 00455	 T102
 5 Silver Rock™	 V442	 P110	 E201	 P603	
 ST0701	 V423	 P550	 E202		
 ST0702	 V500				

PRE-BUILT SAFETY KITS

ABUS offers a variety of pre-built safety kits that meet a variety of needs. These kits offer the most popular combinations of lockout/tagout components to ensure your facility is OSHA compliant.

	K800 Construction LOTO Kit	K900 Basic Pouch Kit	K905 Standard Pouch Kit	K915 Deluxe Pouch Kit	K925 Electrical Toolbox Kit	K930 Valve Toolbox Kit	K945 Operator Toolbox Kit
B100 Small Pouch		1					
B102 Large Pouch	1		1	1			
B200 Toolbox					1	1	1
72/30CAB 4" Cable Padlock	1						
72/40 Aluminum Padlock	2						
74/40 Insulated Padlock		2	2	2	3	3	1
74HB/40-75 Insulated Padlock				2			
C506 6' Safelex™ Cable Lockout						1	
E201 Single-Pole Breaker Lockout	1	1			3	1	
E202 Multi-Pole Breaker Lockout	1		1	3			1
E250 Wall Switch Lockout				1		1	
Universal Plug Lockout	1						
P110 Small Power Plug Lockout				1	1		
P550 Large Power Plug Lockout				1	1		
ST0701 1" Hasp		1	1	2	3	1	1
ST0702 1.5" Hasp		1	1	2			
T100 Do Not Operate Tag & Cable Ties 10pk	1	1	1	1	1	1	1
V303 1-2.5" Gate Valve Lockout			1		1	1	
V305 2.5"-5" Gate Valve Lockout			1	1		1	
V442 Small Ball Valve Lockout						2	



K800 Construction LOTO Kit



K900 Basic Pouch Kit



K915 Deluxe Pouch Kit



K930 Valve Toolbox Kit



K905 Standard Pouch Kit



K925 Electrical Toolbox Kit



K945 Operator Toolbox Kit

Lockout Stations

- Lockout/Tagout Stations centralize LOTO activity
- Portable and wall-mounted
- Designed with durability for industrial settings
- Each hook can hold 2 padlocks or 2 hasps



Part Number	Board Width	Board Height	Includes #Locks	Includes #Hasps	Includes #Tags	Case Pk Quantity
71130	11"	11"	3	2	10	1
71140	15"	15"	8	2	10	1
71150	15"	23"	12	2	10	1
71160	23"	23"	28	4	10	1

Lockout Cabinets

- Lockout cabinets are designed to store padlocks and equipment* in one location
- Constructed of unbreakable ABS: a non-conductive and non-rusting material that can withstand industrial settings
- Clear door allows for visual management of contents



Part Number	Cabinet Width	Cabinet Height	Case Pk Quantity
17053	9"	9"	1
17054	15"	15"	1
17055	15"	30"	1

*Padlocks and equipment not included.

PADLOCK STATIONS



- Constructed of heavy gauge carbon steel with a durable powder coat finish, ideal for industrial settings
- Ready to wall mount near lockout point

Part Number	Size	Station Width	Station Height	Holds #Locks	Case Pk Quantity
18030	Small	6"	3"	5	1
18031	Medium	10 1/2"	3"	10	1
18032	Large	16"	3 1/4"	15	1
18033	XLarge	21 1/4"	3 1/4"	20	1

SECURITY PADLOCKS

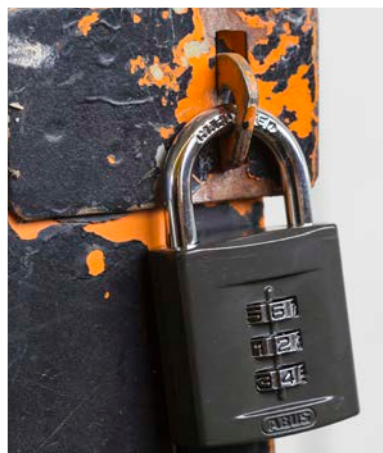

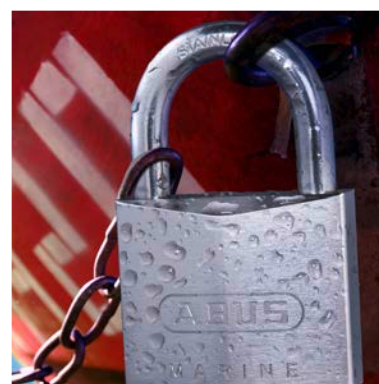
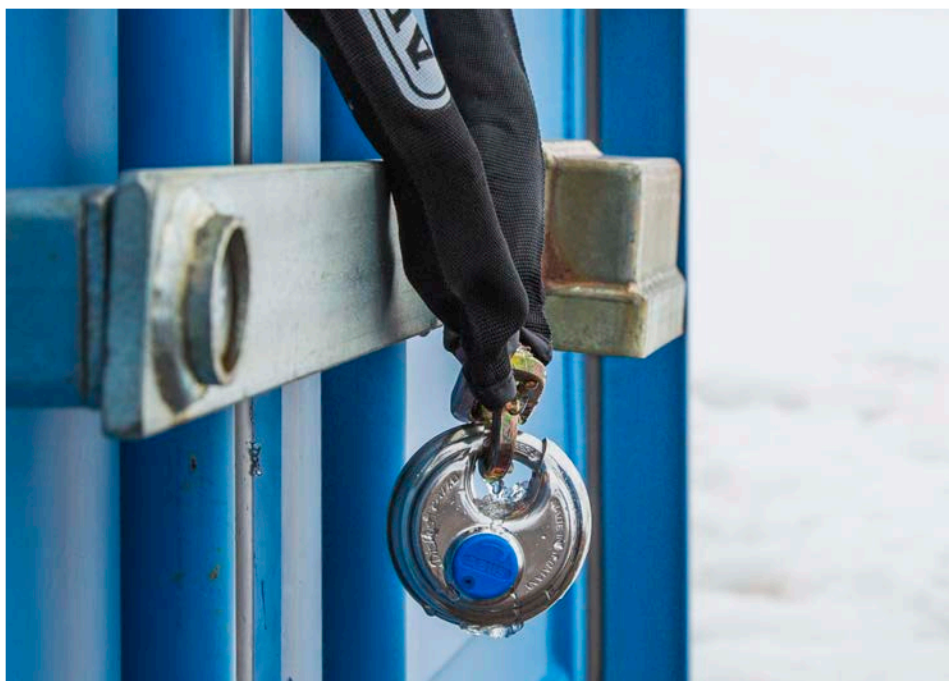



Silver Rock™ 5/50

From building materials, to tools, to heavy equipment, construction site theft is an industry-wide challenge. In addition to the direct costs of replacing stolen goods, there is also the indirect cost due to increased insurance premiums, rentals to replace stolen equipment and lost productivity. One of the most common construction site security solutions is a jobsite box. ABUS has created a solid lock body padlock to take jobsite protection to the next level.

SILVER ROCK™ 5

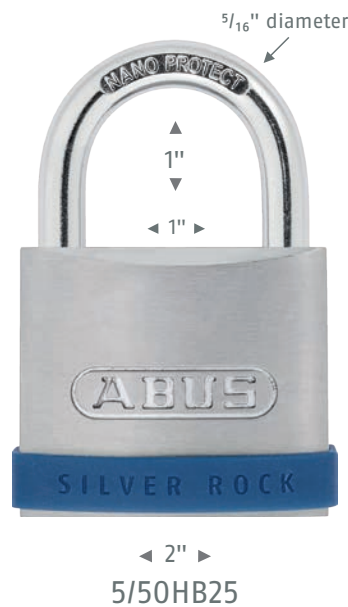

- Solid zinc lock body keeps equipment safe and withstands outdoor elements
- Hardened steel shackle with NANO PROTECT™ coating for increased protection against rust
- A precision 5-pin cylinder with paracentric keyway protects against tampering
- Works with most jobsite boxes



Item	Body Width	Horizontal Shackle Clearance	Vertical Shackle Clearance	Shackle Diameter	Pins in Cylinder	Key Options	Case Pk Quantity
5/50HB25	2"	1"	1"	5/16"	5	KD, KA	6



Diskus®

Developed by ABUS over 70 years ago, the ABUS Diskus® is the original disc shaped padlock of its kind. Its rounded shackle is recessed on two sides of the lock body preventing tampering for break-in attempts. The Diskus® series provides exceptional workmanship in its welding and offers key copy protection. Available in stainless steel and hardened steel.

HIGH SECURITY DISKUS® 20

- Original Diskus® design: 360° protection
- 100% non-corrosive stainless steel
- Diskus® Deep-Welding Technology provides strength and pry resistance
- Shackle made from stainless steel
- Anti-cut plate
- ABUS-Plus disk cylinder: highest protection against manipulation, high number of key differs, drilling and pulling protected

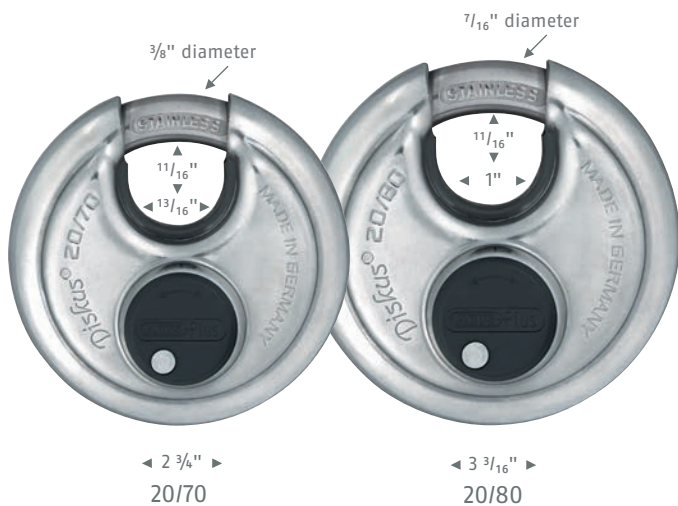

Item	Body Width	Horizontal Shackle Clearance	Vertical Shackle Clearance	Shackle Diameter	Pins in Cylinder	Key Options	Case Pk Quantity
20/70	2 3/4"	13/16"	1 1/16"	3/8"	6	KD, KA, MK	6
20/80	3 3/16"	1"	1 1/16"	7/16"	6	KD, KA, MK	3

WEATHERPROOF DISKUS® 24IB

- Original Diskus® design: 360° protection
- 100% non-corrosive: shackle and all inner components made of stainless steel
- Diskus® Deep-Welding Technology provides maximum strength and pry resistance
- Precision pin cylinder - extra plated for ultimate corrosion resistance

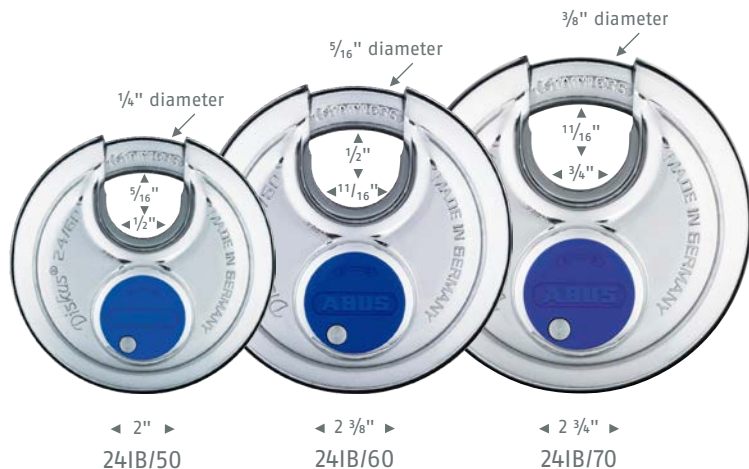

Item	Body Width	Horizontal Shackle Clearance	Vertical Shackle Clearance	Shackle Diameter	Pins in Cylinder	Key Options	Case Pk Quantity
24IB/50	2"	1/2"	5/16"	1/4"	4	KD, KA	6
24IB/60 C	2 3/8"	1 1/16"	1/2"	5/16"	4	KD, KA	6
24IB/60	2 3/8"	1 1/16"	1/2"	5/16"	4	KD, KA, MK	6
24IB/70 C	2 3/4"	3/4"	1 1/16"	3/8"	5	KD, KA	6
24IB/70	2 3/4"	3/4"	1 1/16"	3/8"	5	KD, KA, MK	6

DIMPLE-KEY DISKUS® 25

- High precision reversible key with 8,000 key differs
- Spare keys can only be ordered with assigned code
- 100% non-corrosive stainless steel
- Shackle made from hardened steel
- Original Diskus® design: 360° protection
- Anti-cut plate
- Diskus® Deep-Welding Technology provides maximum strength and pry resistance
- Key retaining: lock retains key until locked



Item	Body Width	Horizontal Shackle Clearance	Vertical Shackle Clearance	Shackle Diameter	Pins in Cylinder	Key Options	Case Pk Quantity
25/70	2 13/16"	3/4"	1 1/16"	3/8"	8	KD	6

STAINLESS STEEL DISKUS® 26

- 100% non-corrosive stainless steel inside and out
- Massive inner base for enhanced security
- Anti-cut plate
- Special alloy hardened steel shackle
- Precision pin cylinder, drilling and pulling protected
- Diskus® Deep-Welding Technology provides maximum strength and pry resistance
- Original Diskus® design: 360° protection
- Key retaining: lock retains key until locked

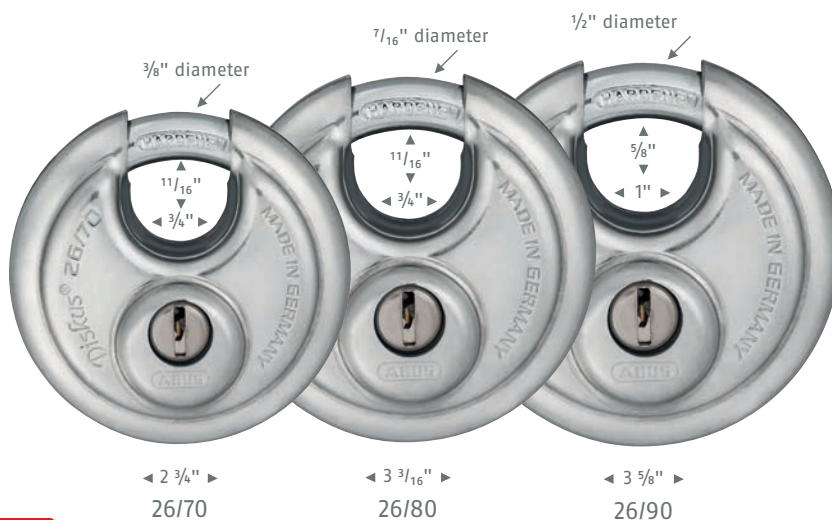

Item	Body Width	Horizontal Shackle Clearance	Vertical Shackle Clearance	Shackle Diameter	Pins in Cylinder	Key Options	Case Pk Quantity
26/70	2 3/4"	3/4"	1 1/16"	3/8"	5	KD, KA, MK	6
26/80	3 3/16"	1"	3/4"	7/16"	6	KD, KA, MK	3
26/90	3 5/8"	1"	5/8"	1/2"	6	KD, KA, MK	3

HARDENED STEEL DISKUS® 28

- Original Diskus® design: 360° protection
- Diskus® Deep-Welding Technology provides maximum strength and pry resistance
- Shackle made from hardened steel
- Precision pin cylinder with anti-pick pins

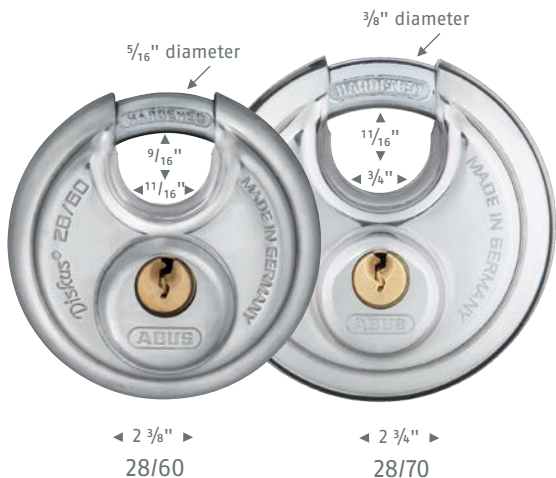

Item	Body Width	Horizontal Shackle Clearance	Vertical Shackle Clearance	Shackle Diameter	Pins in Cylinder	Key Options	Case Pk Quantity
28/60	2 3/8"	11/16"	9/16"	5/16"	4	KD, KA	6
28/70 C	2 3/4"	3/4"	11/16"	3/8"	5	KD	6
28/70	2 3/4"	3/4"	11/16"	3/8"	5	KD, KA	6

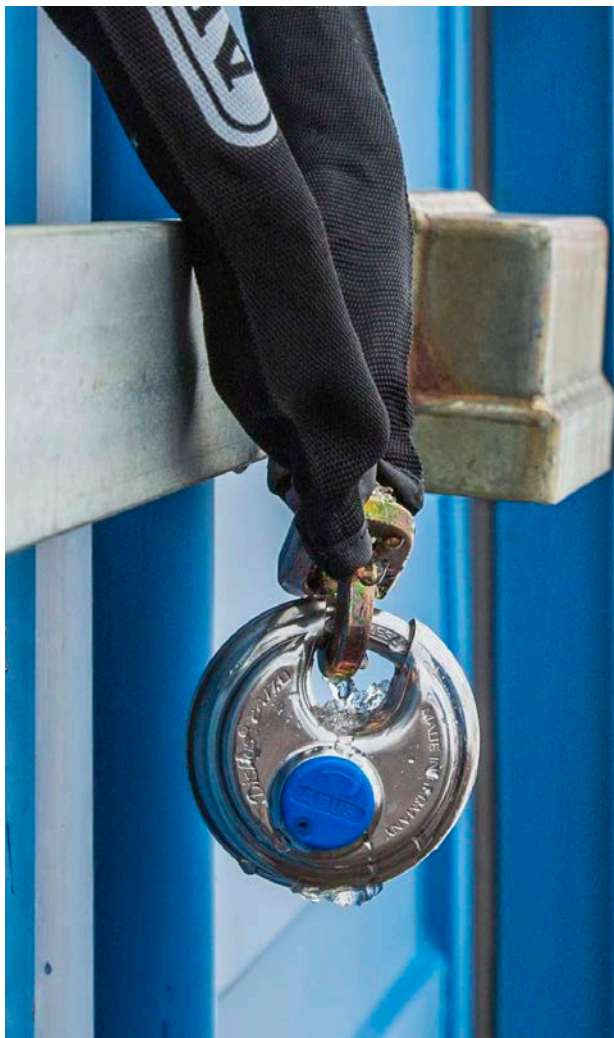

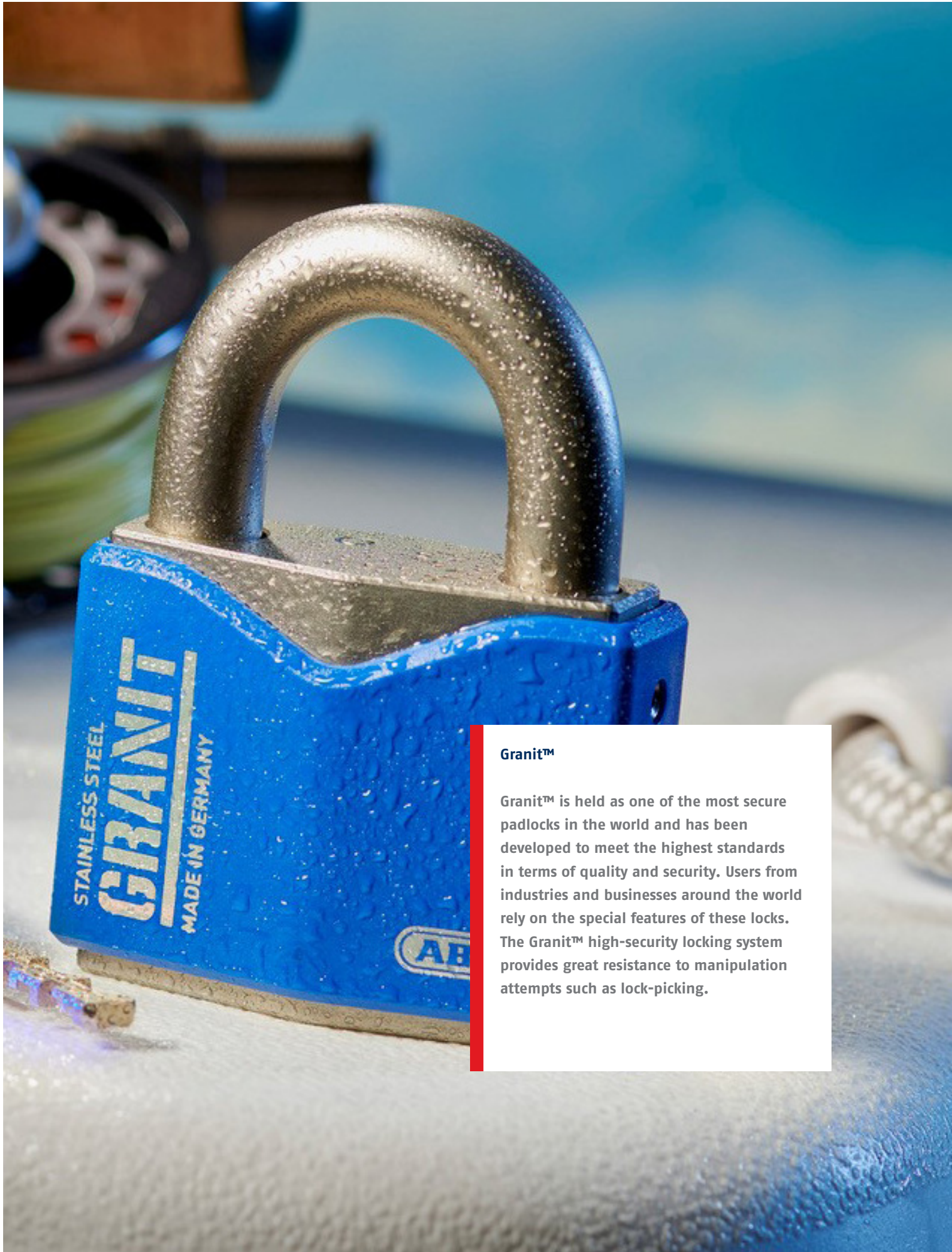

Granit™

Granit™ is held as one of the most secure padlocks in the world and has been developed to meet the highest standards in terms of quality and security. Users from industries and businesses around the world rely on the special features of these locks. The Granit™ high-security locking system provides great resistance to manipulation attempts such as lock-picking.

GRANIT™ 37[RK]/55



- Shackle and body made from hardened alloy steel
- ABUS-Plus disk cylinder, highest protection against manipulation, high number of key differs
- Black Granit™ coating for high corrosion resistance
- Cylinder can be rekeyed to match an existing key
- 2 keys, 1 with LED light

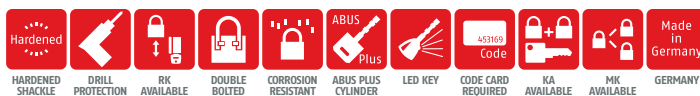

Item	Body Width	Horizontal Shackle Clearance	Vertical Shackle Clearance	Shackle Diameter	Pins in Cylinder	Key Options	Case Pk Quantity
37RK/55	2 7/16"	1 1/16"	1 1/16"	7/16"	7	KD, KA, MK	3
37/55	2 7/16"	1 1/16"	1 1/16"	7/16"	7	KD	1
37/55HB50	2 7/16"	1 1/16"	2"	7/16"	7	KD, KA, MK	3
37/55HB75	2 7/16"	1 1/16"	3"	7/16"	7	KD, KA, MK	4

GRANIT™ 37ST/55



- Body and shackle made of stainless steel
- Inner parts made of non-corrosive materials
- ABUS-PLUS disk cylinder, highest protection against manipulation, high number of key differs
- Cylinder inserts from the top: optimum drill and pull resistance
- 2 keys, 1 with LED light



Item	Body Width	Horizontal Shackle Clearance	Vertical Shackle Clearance	Shackle Diameter	Pins in Cylinder	Key Options	Case Pk Quantity
37ST/55	2 7/16"	1 1/16"	1 1/16"	7/16"	7	KD	2

GRANIT™ 37RK/70

- Body and shackle made from hardened alloy steel
- ABUS-Plus disk cylinder, highest protection against manipulation, high number of key differs
- Cylinder inserted from the top: optimum drill and pull resistance
- Black Granit™ coating for high corrosion resistance
- Cylinder can be rekeyed to match an existing key
- 2 keys, 1 with LED light

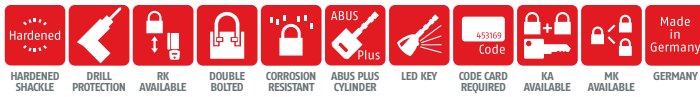

Item	Body Width	Horizontal Shackle Clearance	Vertical Shackle Clearance	Shackle Diameter	Pins in Cylinder	Key Options	Case Pk Quantity
37RK/70	3"	1 1/8"	1 3/8"	9/16"	7	KD, KA, MK	1

GRANIT™ 37[RK]/60, 80

- Hardened alloy steel body and shackle
- ABUS-Plus disk cylinder, highest protection against manipulation, high number of key differs
- Cylinder inserted from the top: optimum drill and pull resistance (37RK/80)
- Shackle guard provides extra protection
- Corrosion-resistant Black Granit™ coating
- Cylinder can be rekeyed to match an existing key
- 2 keys, 1 with LED light



Item	Body Width	Horizontal Shackle Clearance	Vertical Shackle Clearance	Shackle Diameter	Pins in Cylinder	Key Options	Case Pk Quantity
37RK/60	2 9/16"	1 1/16"	5/8"	7/16"	7	KD	1
37/60	2 9/16"	1 1/16"	5/8"	7/16"	7	KD	1
37RK/80	3 1/8"	7/8"	7/8"	1/2"	7	KD, KA, MK	1





Laminated Steel

ABUS laminated steel padlocks are suitable for a variety of applications. Laminated locks provide an extra level of corrosion resistance with their individually coated steel plates. Available in a range of sizes and colors.

LAMINATED STEEL 41

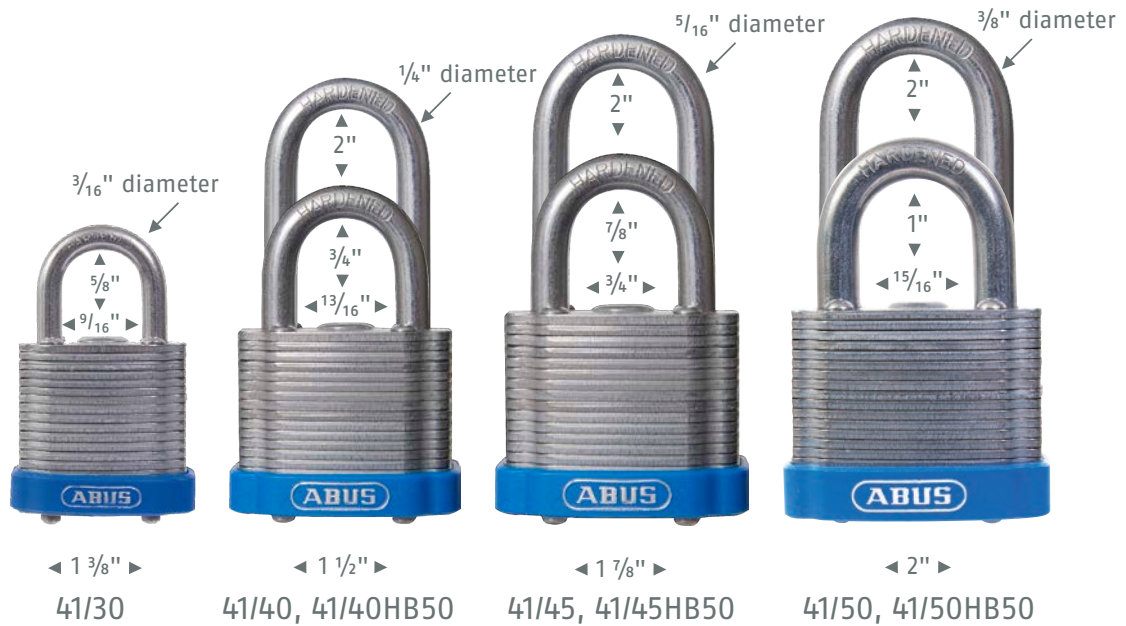

- Laminated steel with ETERNA™ coating on each laminate for extreme corrosion resistance
- ETERNA™: Non-hazardous, cadmium-free plating
- Tough, countersunk rivets
- Hardened steel shackle
- High-precision 5-pin tumbler, drilling and pulling protected
- Plastic bumper for easy identification



Item	Body Width	Horizontal Shackle Clearance	Vertical Shackle Clearance	Shackle Diameter	Pins in Cylinder	Key Options	Case Pk Quantity
41/30	1 3/8"	9/16"	5/8"	3/16"	4 or 5	KD, KA, MK	4
41/40 C	1 1/2"	13/16"	3/4"	1/4"	4 or 5	KD	6
41/40	1 1/2"	13/16"	3/4"	1/4"	4 or 5	KD, KA, MK	6
41/40HB50	1 1/2"	13/16"	2"	1/4"	4 or 5	KD, KA, MK	6
41/45	1 7/8"	3/4"	7/8"	5/16"	4 or 5	KD	6
41/45HB50	1 7/8"	3/4"	2"	5/16"	4 or 5	KD, KA, MK	6
41/50 C	2"	15/16"	1"	3/8"	4 or 5	KD	6
41/50	2"	15/16"	1"	3/8"	4 or 5	KD, KA, MK	6
41/50HB50	2"	15/16"	2"	3/8"	4 or 5	KD, KA	6



Brass

The ABUS brass material provides corrosion resistance to the lock body. The brass padlock range includes many different sizes, shapes, shackles, and other additions.

TRADITIONAL BRASS 55



- Solid brass body offers maximum corrosion resistance
- Available with hardened steel or brass shackle
- Inner components made from non-corrosive materials
- Perfect solution for outdoor security applications



Item	Body Width	Horizontal Shackle Clearance	Vertical Shackle Clearance	Shackle Diameter	Pins in Cylinder	Shackle Material	Key Options	Case Pk Quantity
55/25 C	1 5/16"	7/16"	7/16"	1/16"	3	Steel	KD, KA	12
55/30 C	1 1/8"	9/16"	1/2"	3/16"	3	Steel	KD	12
55/30	1 1/8"	9/16"	1/2"	3/16"	3	Steel	KD, KA	12
55MB/30 C	1 1/8"	9/16"	1/2"	3/16"	3	Brass	KD	12
55/40 C	1 1/2"	13/16"	7/8"	1/4"	4	Steel	KD	12
55/40	1 1/2"	13/16"	7/8"	1/4"	4	Steel	KD, KA	12
55MB/40 C	1 1/2"	13/16"	7/8"	1/4"	4	Brass	KD, KA	12
55MB/40	1 1/2"	13/16"	7/8"	1/4"	4	Brass	KD, KA	12
55/40HB63 C	1 1/2"	13/16"	2 1/2"	1/4"	4	Brass	KD	6
55/45 C	1 3/4"	15/16"	5/16"	1/4"	4	Steel	KD	6
55/45	1 3/4"	15/16"	5/16"	1/4"	4	Steel	KD, KA	6
55/50 C	1 7/8"	1"	15/16"	1/4"	5	Steel	KD	6
55/50	1 7/8"	1"	15/16"	1/4"	5	Steel	KD, KA	6
55MB/50 C	1 7/8"	1"	15/16"	1/4"	5	Brass	KD, KA	6
55/60 C	2 1/4"	1 1/4"	1 1/4"	5/16"	5	Steel	KD, KA	6

TRADITIONAL BRASS 65

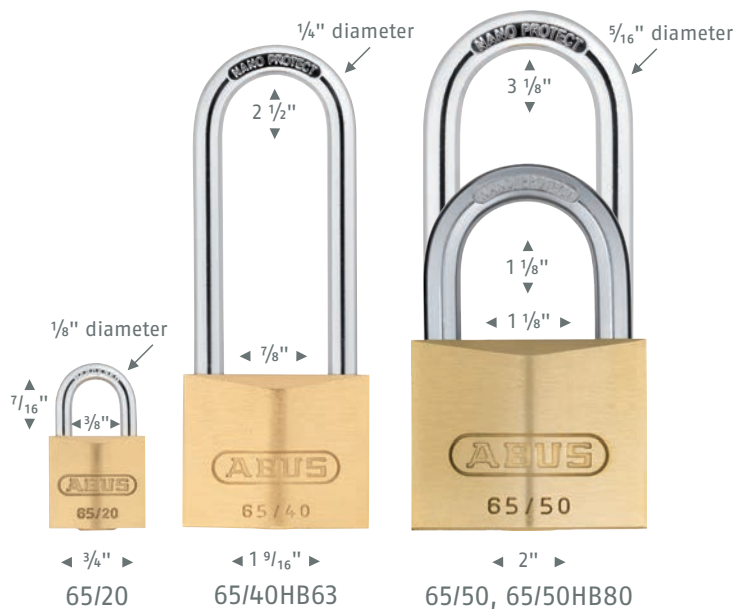

- Body made from solid brass
- Shackle made from hardened steel with NANO PROTECT™ coating
- Inner components made from non-corrosive materials
- Precision pin tumbler



Item	Body Width	Horizontal Shackle Clearance	Vertical Shackle Clearance	Shackle Diameter	Pins in Cylinder	Key Options	Case Pk Quantity
65/20 C	3/4"	3/8"	7/16"	1/8"	3	KD, KA	6
65/40HB63 C	1 9/16"	7/8"	2 1/2"	1/4"	5	KD, KA	6
65/50 C	2"	1 1/8"	1 1/8"	5/16"	5	KD, KA	6
65/50HB80 C	2"	1 1/8"	3 1/8"	5/16"	5	KD, KA	6

HIGH SECURITY BRASS 85



- Body made of solid brass
- Inner components made of non-corrosive materials
- Hardened steel shackle with NANO PROTECT™ coating
- Precision pin cylinder with mushroom pins
- Paracentric keyway for increased protection against manipulation
- Can be made keyed alike to already existing keys/locks
- Automatic locking: Locking without key by pushing down the shackle



Item	Body Width	Horizontal Shackle Clearance	Vertical Shackle Clearance	Shackle Diameter	Pins in Cylinder	Key Options	Case Pk Quantity
85/40	1 9/16"	7/8"	7/8"	1/4"	5	KD, KA, MK	3
85/40HB63	1 9/16"	7/8"	2 1/2"	1/4"	5	KD, KA, MK	6
85/50HB80	2"	1 1/8"	3 1/8"	5/16"	5	KD, KA, MK	6

CHROME-PLATED BRASS 88

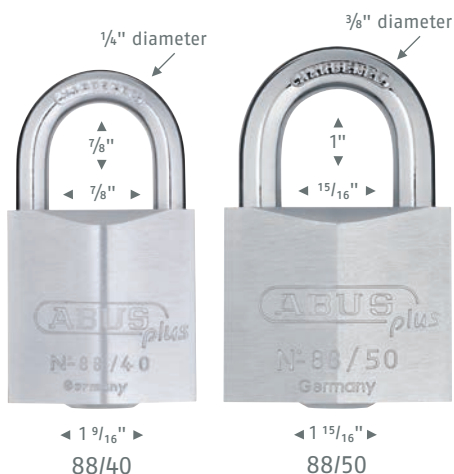

- Lock body made from solid brass
- Chrome-plated lock body for better corrosion resistance
- Double bolted
- Shackle made from hardened alloy steel
- ABUS-Plus disc cylinder: highest protection against manipulation
- Cylinder can be re-keyed to match an existing key
- Key retaining: locking only with the key (lock retains key until locked)



Item	Body Width	Horizontal Shackle Clearance	Vertical Shackle Clearance	Shackle Diameter	Pins in Cylinder	Key Options	Case Pk Quantity
88/40 C	1 9/16"	7/8"	7/8"	1/4"	7	KD	6
88/40	1 9/16"	7/8"	7/8"	1/4"	7	KD, KA	6
88/50 C	1 15/16"	15/16"	1"	3/8"	7	KD	6
88/50	1 15/16"	15/16"	1"	3/8"	7	KD, KA	6

WEATHERPROOF BRASS 70

- Solid brass body with shock-absorbing vinyl cover provide ultimate weather resistance
- Cylinder cover with drainage channels protects padlock from water and dirt
- Inner components made from rust-free materials
- IB: comes with stainless steel shackle



Item	Body Width	Horizontal Shackle Clearance	Vertical Shackle Clearance	Shackle Diameter	Pins in Cylinder	Key Options	Case Pk Quantity
70/35	1 5/16"	1/2"	15/16"	1/4"	4	KD	12
70/45 C	1 3/4"	13/16"	1"	5/16"	7	KD, KA	6
70/45HB63	1 3/4"	13/16"	2 1/2"	5/16"	5	KD, KA	6
70IB/45 C	1 3/4"	13/16"	7/8"	5/16"	5	KD, KA, MK	6
70IB/45HB63	1 3/4"	13/16"	2 1/2"	5/16"	5	KD, KA, MK	6
70IB/50 C	2"	15/16"	1 1/16"	3/8"	5	KD, KA, MK	6

WEATHERPROOF BRASS 75IB

- High-precision reversible keyway with up to 150,000 key differs
- Body made of pearl-nickel-plated brass
- Shackle made from stainless steel
- Dimple key
- Key-retaining: 75IB/40 + 75IB/50
- Self-locking: 75IB/30

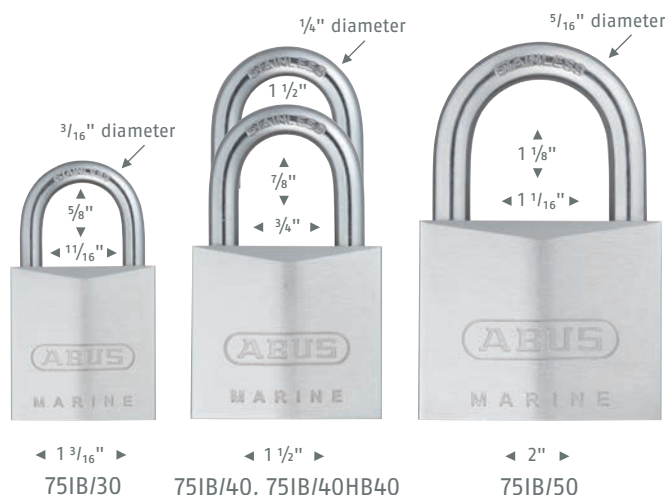

Item	Body Width	Horizontal Shackle Clearance	Vertical Shackle Clearance	Shackle Diameter	Total Height	Pins in Cylinder	Key Options	Case Pk Quantity
75IB/30	1 3/16"	11/16"	5/8"	3/16"		8	KD, KA	12
75IB/40	1 1/2"	3/4"	7/8"	1/4"		8	KD, KA	12
75IB/40HB40	1 1/2"	3/4"	1 1/2"	1/4"		8	KD, KA	12
75IB/50	2"	1 1/16"	1 1/8"	5/16"		10	KD, KA	6

WEATHERPROOF BRASS 84IB



- Lock body made of nickel-plated solid brass
- Shackle made of stainless steel
- Inner components made of non-corrosive materials
- Precision pin tumbler
- Self-locking: locking without a key by pushing down the shackle



Item	Body Width	Horizontal Shackle Clearance	Vertical Shackle Clearance	Shackle Diameter	Key Options	Case Pk Quantity
84IB/40 C	1 1/2"	13/16"	13/16"	1/4"	KD	6
84IB/50 C	1 7/8"	1"	1"	5/16"	KD	6
84IBHB/50 C	1 7/8"	1"	2"	5/16"	KD	6

WEATHERPROOF BRASS T84MB

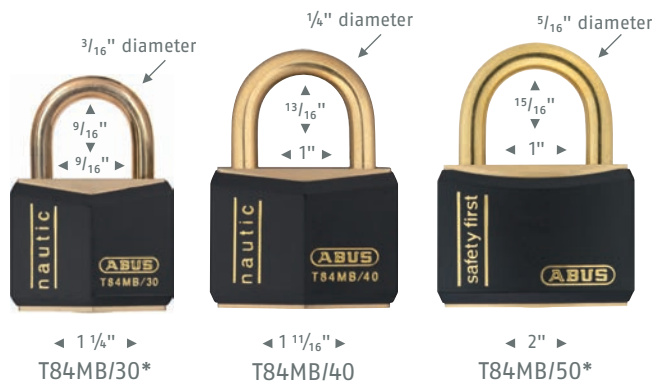

- Body and shackle made of solid brass
- Inner components made of non-corrosive materials
- Precision pin tumbler



Item	Body Width	Horizontal Shackle Clearance	Vertical Shackle Clearance	Shackle Diameter	Pins in Cylinder	Key Options	Case Pk Quantity
T84MB/30* C	1 1/4"	9/16"	9/16"	3/16"	3	KD, KA	12
T84MB/40 C	1 11/16"	1"	13/16"	1/4"	4	KD, KA	12
T84MB/40	1 11/16"	1"	13/16"	1/4"	4	KD	12
T84MB/50* C	2"	1"	15/16"	5/16"	5	KD, KA	6

*Available only with black jacket.



Monoblock

The ABUS Monoblock Series is a uniquely designed brass padlock that provides maximum resistance to bolt cutters. These padlocks provide ultimate security when paired with ABUS high security chain.

MONOBLOCK BRASS 82

- Brass body offers strength and rust resistance
- Unique padlock design with hardened steel shackle and pin provides maximum resistance to bolt cutters
- Ultimate security when paired with ABUS security chain

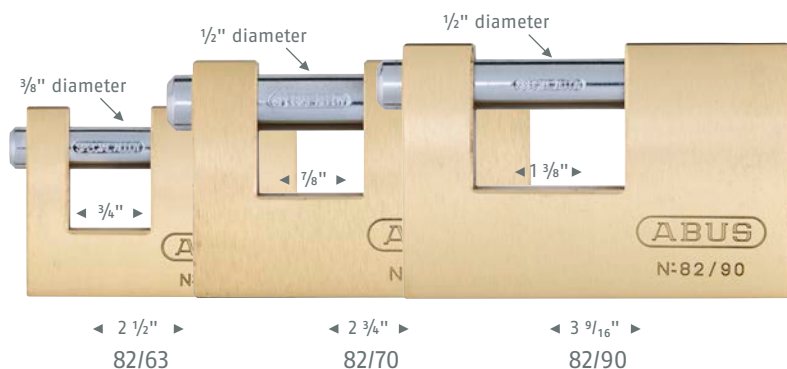

Item	Body Width	Horizontal Shackle Clearance	Shackle Diameter	Pins in Cylinder	Key Options	Case Pk Quantity
82/63	2 1/2"	3/4"	3/8"	5	KD, KA	6
82/70	2 3/4"	7/8"	1/2"	5	KD, KA	6
82/90	3 9/16"	1 3/8"	1/2"	5	KD, KA	6

MONOBLOCK STEEL 92, 93

- Body made from solid brass with steel jacket
- Hardened steel shackle with NANO PROTECT™ coating
- Precision pin tumbler
- Perfect for use with ABUS security chain

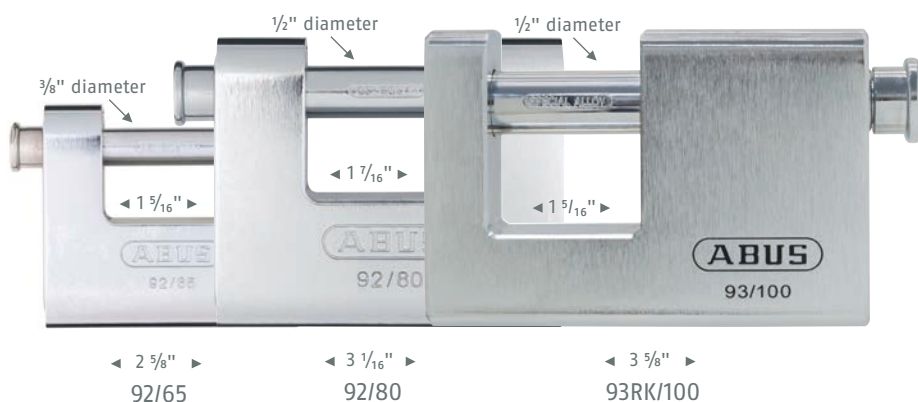

REKEYABLE 93

- Can be keyed in to many popular keyways
- CEN Class 6 rating - maximum security
- Cylinder not included

Item	Body Width	Horizontal Shackle Clearance	Shackle Diameter	Pins in Cylinder	Key Options	Case Pk Quantity
92/65	2 5/8"	1 5/16"	3/8"	5	KD, KA	3
92/80	3 1/16"	1 7/16"	1/2"	5	KD, KA	3
93RK/100	3 5/8"	1 5/16"	1/2"	5	KD, KA	3



TITALIUM™

TITALIUM™ is a special aluminum alloy that uniquely combines a high level of strength with lightness. TITALIUM™ series padlocks all feature an impressive stainless-steel finish. Within the TITALIUM™ range, there are three standard lines in various sizes for individual security requirements. With the flagship 80TI series, the main 64TI range and the entry-level 54TI series, ABUS offers a versatile range of security solutions for both private and commercial applications.

TITALIUM™ 54TI

- Solid lock body made of TITALIUM™ aluminum alloy: light, but secure
- Hardened steel shackle, difficult to cut
- Just as strong as traditional brass padlocks

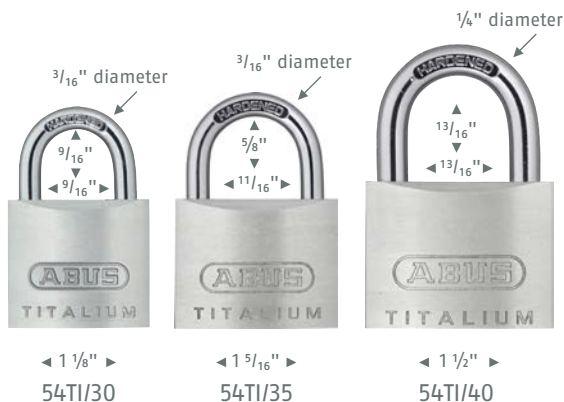

Item	Body Width	Horizontal Shackle Clearance	Vertical Shackle Clearance	Shackle Diameter	Pins in Cylinder	Key Options	Case Pk Quantity
54TI/30 C	1 1/8"	9/16"	9/16"	3/16"	KD	6	4
54TI/35 C	1 5/16"	11/16"	5/8"	3/16"	KD	6	4
54TI/40 C	1 1/2"	13/16"	13/16"	1/4"	KD	6	4

TITALIUM™ 80TI

- Solid lock body made from TITALIUM™ aluminum alloy: higher security, less weight
- Hardened steel shackle with NANO PROTECT™ coating
- Paracentric keyway for increased protection against manipulation
- Just as strong as traditional brass padlocks

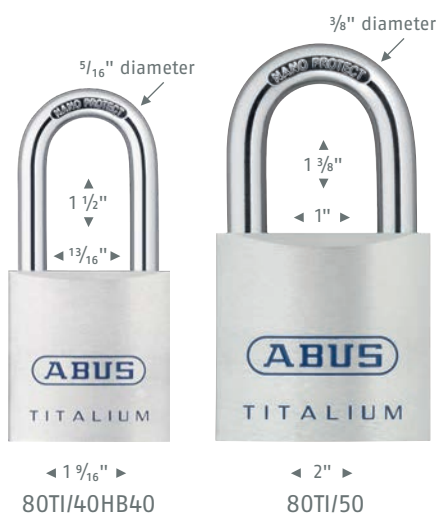

Item	Body Width	Horizontal Shackle Clearance	Vertical Shackle Clearance	Shackle Diameter	Pins in Cylinder	Key Options	Case Pk Quantity
80TI/40HB40 C	1 1/2"	13/16"	1 9/16"	5/16"	6	KD, KA	4
80TI/50 C	2"	1"	1 3/8"	3/8"	6	KD, KA	4

TITALIUM™ 64TI

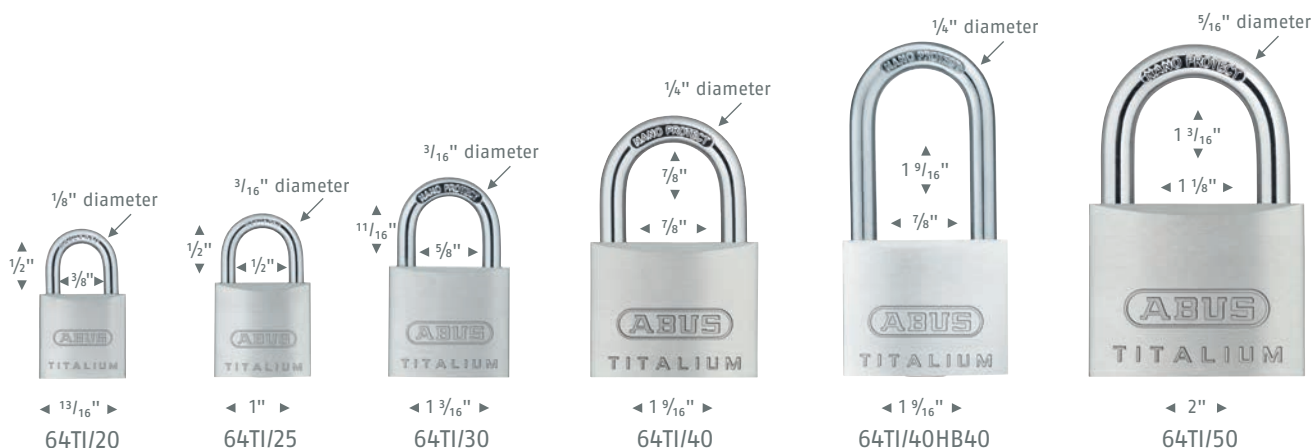

- Solid lock body made from TITALIUM™ aluminum alloy: higher security, less weight
- Hardened steel shackle with NANO PROTECT™ coating for superior corrosion resistance
- Paracentric keyway for increased protection against manipulation
- Just as strong as traditional brass padlocks



Item	Body Width	Horizontal Shackle Clearance	Vertical Shackle Clearance	Shackle Diameter	Pins in Cylinder	Key Options	Case Pk Quantity
64TI/20 C	13/16"	3/8"	1/2"	1/8"	KD	3	6
64TI/25 C	1"	1/2"	1/2"	3/16"	KD	4	6
64TI/30 C	1 3/16"	5/8"	1 1/16"	3/16"	KD	4	6
64TI/40 C	1 9/16"	7/8"	7/8"	1/4"	KD	5	6
64TI/40HB40 C	1 9/16"	7/8"	1 9/16"	1/4"	KD, KA	5	6
64TI/50 C	2"	1 1/8"	1 3/16"	5/16"	KD, KA	5	6

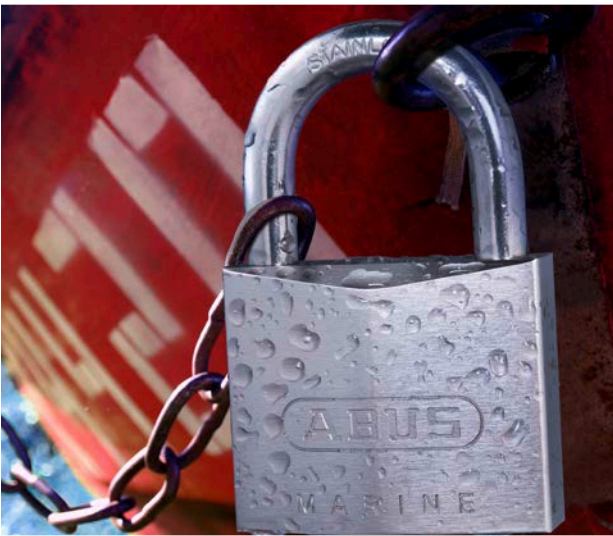



83 Series®

Precision and quality, fast rekeying, easy shackle changing, function convertibility and the development of the NANO PROTECT™ plating for extreme corrosion resistance are standard with the ABUS 83 Series®. Many 83 Series® padlocks are also available with Interchangeable Core feature to allow for use with many different OEM keyways.

83 SERIES®

The Locksmith's Padlock of Choice



Features

KnK Cylinder Compatibility

Most OEM KnK cylinder assemblies will fit into the new 83 Series® padlocks. The use of special adapters is required. KnK Adapter Kit Includes: Bible Cover, Schlage® & Primus®, Medeco®, Mul-T-Lock®, Ilco®/Sargent Knk Drivers.



KnK Adapter Kit

3-in-1 Bolt Driver

The 3-in-1 bolt driver setup has been retained for the large steel-bodied padlocks. Changing shackles becomes much simpler using this tools as the spring does not need to be reset. The 3-in-1 bolt driver is used in the 83/55, 83CS/55, 83/80 and 83WP/63 Series as well as all IC padlocks.



3-in-1 Bolt Driver

Shackle Changing Tools

There are two new shackle changing tools for use with the ABUS 83 Series®. Version 1 is a solid aluminum, steel tip tool designed for use in the workshop environment. Version 2 is an economy version of this tool, designed for use in a van or onsite and when only a smaller number of shackles needs to be changed. A flat bladed screwdriver can no longer be used to remove the shackle, reducing the likelihood of a consumer accidentally doing so.



Professional Aluminum Shackle Change Tool

Symmetrical Z-Bar

A new 83 Series® Z-bar has been designed for use in converting from key-retaining to non-key-retaining in seconds. It looks similar to the existing Z-bar, but is symmetrical and has a black dot printed on it, distinguishing it from the old Z-bar which is produced with a red dot. The old Z-bar is shaped differently than the new Z-bar, therefore the two are not interchangeable.



New Z-Bar

Easy Shackle Change Feature

The popular "Easy Shackle Change" feature has been expanded to all 83ALs, 83/45, 83KnK/45, 83/50, 83MAR/45, 83WP/IB/53, 83WP/53 and most IC padlocks.

Shackle Collar and Chain

With an ABUS shackle collar and chain, you can affix any one of our 83 Series® padlocks to a specific location to help prevent loss and contamination of the padlock. The shackle collar slides up the leg of the shackle and holds the chain attached to the padlock when open. Shackle collars are available for 5/16", 3/8" and 7/16" diameter shackles and can be purchased individually or in a collar kit which includes 6 collars of each size.



Shackle Collar

83 Service Kit

ABUS 83 Series® Service Kit is the perfect way to keep all your parts for the 83 Series organized in your shop or in your van. The kit includes a variety of shackles for the 83/45, cylinders, KnK bible covers and adapters, Z-bars, easy shackle change tools and much more.



83 Service Kit

Cylinder Cover

A rubberized weatherproof cylinder cover is available for select 83 Series® padlocks. The cover fits snugly on the bottom of the lock and protects the cylinder from precipitation and debris.



Cylinder Cover

Keyways



100	200	300	EVER LVP PATENTED	400	410	700	800	888 ABUS	900	1000	3000	M1 COMBITEC
100 YALE No. 8	200 Kwikset 5-Pin	300 & 306 Schlage C	EVER Schlage EVER	400 Corbin 60 59A1 59A2 5981 5982	410 Corbin L4	700 Sargent L4-LC	800 Weiser Falcon	888 ABUS	900 Arrow	1000 Russwin D1-D4	3000 Schlage C-L	M1 Master M1

Schlage C 300 is 6-5 pin loaded and Schlage C 306 is 6-6 pin loaded Schlage Everest EVER is a composite that will fit all Everest C keyways

TITALIUM™ 83

- Solid lock body made of TITALIUM™ aluminum alloy
- Shackle made of hardened steel with NANO PROTECT™ coating for extra corrosion resistance
- Patented "Z-bar" converts key-retaining to non-key-retaining and vice versa within seconds
- Patented "Pinning Window" for simple rekeying
- Can be keyed into many popular keyways
- Shackle can be changed in seconds



Item	Body Width	Horizontal Shackle Clearance	Vertical Shackle Clearance	Shackle Diameter	Pins in Cylinder	Shackle Height Options	Cylinder Cover Available	Case Pk Quantity
83AL/40	1 1/2"	7/8"	1 1/2"	1/4"	5-6	1, 1 1/2, 3, 4	Y	6
83AL/45	1 3/4"	15/16"	1"	5/16"	5-6	1, 2, 3, 4, 6	Y	6
83AL-IC/40	1 1/2"	7/8"	1 1/2"	1/4"	-	1, 1 1/2, 3, 4	Y	6

BRASS 83

- Body made of solid brass
- Hardened steel shackle with NANO PROTECT™ coating for corrosion resistance
- Patented "Z-bar" converts key-retaining to non-key-retaining and vice versa within seconds
- Patented "Pinning Window" for simple rekeying
- Can be keyed into many popular keyways
- Shackle can be changed in seconds



Item	Body Width	Horizontal Shackle Clearance	Vertical Shackle Clearance	Shackle Diameter	Pins in Cylinder	Shackle Height Options	Cylinder Cover Available	Case Pk Quantity
83/40	1 1/2"	7/8"	1 1/2"	1/4"	5-6	1, 1 1/2, 3, 4	Y	6
83/45	1 3/4"	15/16"	1"	5/16"	5-6	1, 2, 3, 4, 6	Y	6
83CS/45	1 3/4"	7/8"	1"	5/16"	5-6	1, 2, 3, 4, 6	Y	6
83IC/45	1 3/4"	15/16"	1"	5/16"	-	1, 2, 3, 4, 6	Y	6
83KnK/45	1 3/4"	15/16"	1"	5/16"	-	1, 2, 3, 4, 6	Y	6

HARDENED STEEL LFIC 83



- Body made from hardened steel with NANO PROTECT™ coating - same superior corrosion resistance as 83WP
- Hardened steel shackle with NANO PROTECT™ coating, available in different heights
- Padlock can be ordered without shackle to customize lock
- Accepts LFIC Schlage® cylinders
- Accepts all 83WP/53 compatible shackles
- Shackle can be changed in seconds



Item	Body Width	Horizontal Shackle Clearance	Vertical Shackle Clearance	Shackle Diameter	Pins in Cylinder	Shackle Height Options	Cylinder Cover Available	Case Pk Quantity
83S/45 LFIC	1 3/4"	15/16"	1 3/16"	5/16"	-	1 3/16, 2 1/2, 3, 4	N	5-6

PROFESSIONAL PLATED 83



- Body made of chrome-plated solid brass
- Hardened steel shackle with NANO PROTECT™ coating for corrosion resistance
- Patented "Z-bar" converts key-retaining to non-key-retaining and vice versa in seconds
- Patented "Pinning Window" for simple rekeying
- Can be keyed into many popular keyways
- Shackle can be changed in seconds



Item	Body Width	Horizontal Shackle Clearance	Vertical Shackle Clearance	Shackle Diameter	Pins in Cylinder	Shackle Height Options	Cylinder Cover Available	Case Pk Quantity
83/50	1 7/8"	7/8"	1 1/16"	3/8"	5-6	1 3/16, 2, 3, 4	Y	6
83CS/50	1 7/8"	7/8"	1 1/8"	3/8"	5-6	1 7/16, 2, 3, 4	Y	6
83IC/50	1 7/8"	7/8"	1 1/16"	3/8"	-	1, 2, 3, 4	Y	6
83KnK/50	1 7/8"	7/8"	1 1/16"	3/8"	-	1, 2, 3, 4	Y	6
83CS-KnK/50	1 7/8"	7/8"	1 1/8"	3/8"	-	1, 2, 3, 4	Y	6

STEEL ROCK 83

- Body and shackle made from hardened steel, chrome-plated with NANO PROTECT™ coating for an extreme corrosion resistance
- Patented "Z-Bar" converts key-retaining to non-key-retaining and vice versa within seconds
- RK: cylinder can be re-keyed to match an existing key
- CS: shackle guard protects shackle from attack

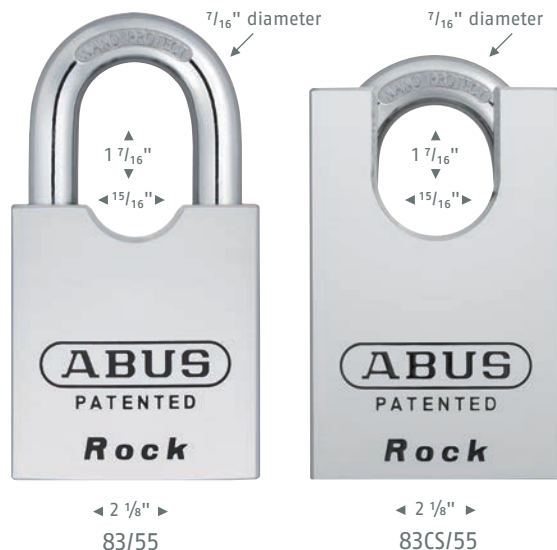

Item	Body Width	Horizontal Shackle Clearance	Vertical Shackle Clearance	Shackle Diameter	Pins in Cylinder	Shackle Height Options	Cylinder Cover Available	Case Pk Quantity
83/55	2 1/8"	1 5/16"	1 7/16"	7/16"	5-6	1, 1 7/16, 3	N	6
83CS/55	2 1/8"	1 5/16"	1 7/16"	7/16"	5-6	1, 1 7/16, 3	N	6
83KnK/55	2 1/8"	1 5/16"	1 7/16"	7/16"	-	1, 1 7/16, 3	N	6
83CS-IC/55	2 1/8"	1 5/16"	1 7/16"	7/16"	-	1, 1 7/16, 3	N	6
83CS-KnK/55	2 1/8"	1 5/16"	1 7/16"	7/16"	-	1, 1 7/16, 3	N	6

STEEL ROCK 83

- Can be adapted to meet various requirements within seconds - no special tools needed
- Body and shackle made from hardened steel, chrome-plated with NANO PROTECT™ coating for extreme corrosion resistance
- Double bolted
- Patented "Z-Bar" converts key-retaining to non-key-retaining and vice versa within seconds

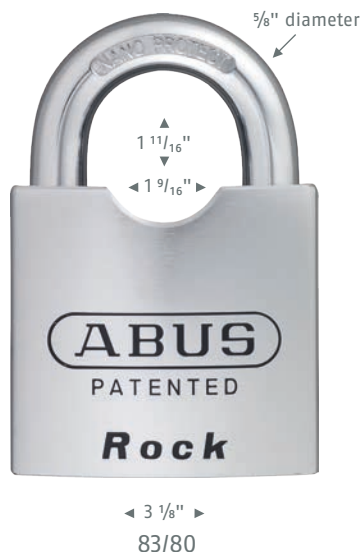

Item	Body Width	Horizontal Shackle Clearance	Vertical Shackle Clearance	Shackle Diameter	Pins in Cylinder	Shackle Height Options	Cylinder Cover Available	Case Pk Quantity
83/80	3 1/8"	1 9/16"	1 11/16"	5/8"	5-6	1 11/16	N	6

WEATHERPROOF 83

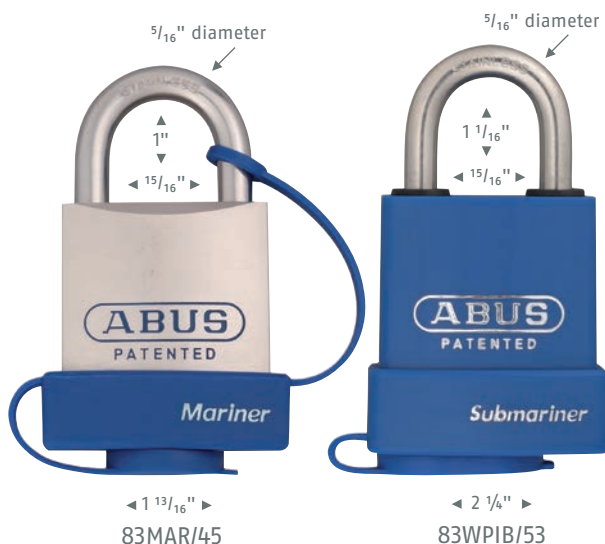

- Brass body with extra plating for perfect corrosion resistance
- Shackle made of stainless steel
- Durable weather cover with drainage system
- Patented "Z-bar" converts key-retaining to non-key-retaining and vice versa within seconds
- Patented "Pinning Window" for simple rekeying
- Can be keyed into many popular keyways
- Shackle can be changed in seconds



Item	Body Width	Horizontal Shackle Clearance	Vertical Shackle Clearance	Shackle Diameter	Pins in Cylinder	Shackle Height Options	Cylinder Cover Available	Case Pk Quantity
84MAR/45	1 13/16"	1 5/16"	1"	5/16"	5-6	1, 2, 3, 4	Y	6
83WPIB/53	2 1/4"	1 5/16"	1 1/16"	5/16"	5-6	1 1/8"	Y	6

WEATHERPROOF 83

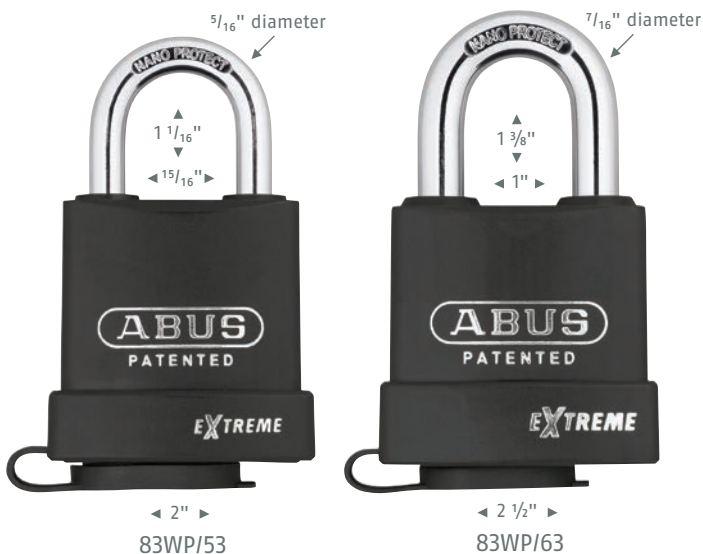

- Shackle and body made of hardened steel with NANO PROTECT™ coating for extra corrosion resistance
- RK: re-key to match an existing key
- Patented "Z-Bar" converts key retaining to non-key retaining and vice versa in seconds
- Patented "Pinning Window" for simple rekeying
- Durable weather cover with drainage
- 83WP/53: shackle can be changed in seconds



Item	Body Width	Horizontal Shackle Clearance	Vertical Shackle Clearance	Shackle Diameter	Pins in Cylinder	Shackle Height Options	Cylinder Cover Available	Case Pk Quantity
83WP/53	2"	1 5/16"	1 1/16"	5/16"	5-6	1 1/16, 2 1/2, 3, 4	Y	6
83WP-IC/53	2"	1 5/16"	1 1/16"	5/16"	-	1 1/16, 2 1/2, 3, 4	Y	6
83WP-KnK/53	2"	1 5/16"	1 1/16"	5/16"	-	1 1/16, 2 1/2, 3, 4	Y	6
83WP-LFIC/53	2"	1 5/16"	1 1/16"	5/16"	-	1 1/16, 2 1/2, 3, 4	Y	6
83WP/63	2 1/2"	1"	1 3/8"	7/16"	5-6	1 3/8, 2 1/2	Y	6
83WP-IC/63	2 1/2"	1"	1 3/8"	7/16"	-	1 3/8, 2 1/2	Y	6
83WP-KnK/63	2 1/2"	1"	1 3/8"	7/16"	-	1 3/8, 2 1/2	Y	6

INTERCHANGEABLE CORE

Features

- Accepts 6-pin and 7-pin SFIC cylinders
- Available in solid aluminum, solid brass, solid brass chrome-plated and solid hardened steel bodied padlocks
- Double-ball shackle locking
- Hardened steel shackle with NANO PROTECT™ coating for extreme corrosion resistance
- 3-in-1 bolt driver makes it easy to change shackles as the spring does not need to be reset
- Patented "Z-bar" allows padlock to be easily converted from non-key-retaining to key-retaining in seconds
- Shackles available in a choice of materials - hardened steel shackle with NANO PROTECT™ coating for extreme corrosion resistance, stainless steel and brass
- Shackles available in a range of lengths from 1" to 6"
- Exchange shackles in seconds with the easy shackle change tool (not available on 83AL-IC/40, 83CS-IC/55 or 83WP-IC/63)
- 83WP-LFIC/53 and 83S/45 LFIC accept LFIC Schlage® cylinders

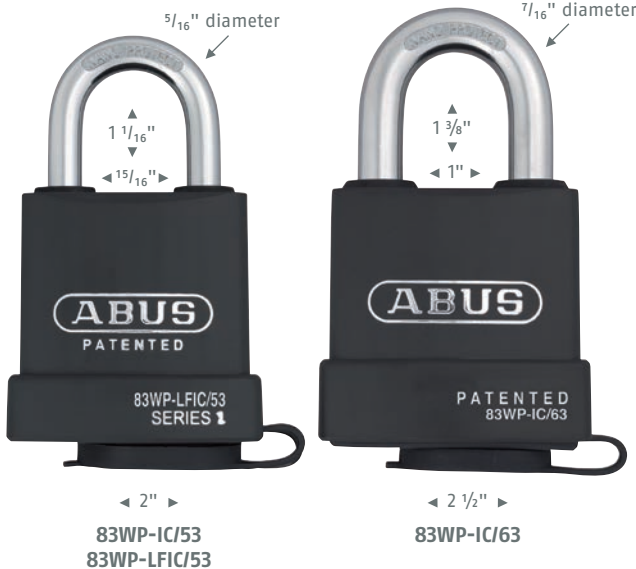

All Drivers Included



Item	Shackle Height (in)	Case Pk Qty
83AL-IC/40	1, 1 1/2, 3, 4	6
83IC/45	1, 2, 3, 4, 6	6
83S/45 LFIC	1 3/16, 2 1/2, 3, 4	6
83IC/50	1, 2, 3, 4	6
83CS-IC/55	1, 1 7/16, 3	6
83WP-IC/53	1 1/16, 2 1/2, 3, 4	6
83WP-LFIC/53	1 1/16, 2 1/2, 3, 4	6
83WP-IC/63	1 3/8, 2 1/2	6

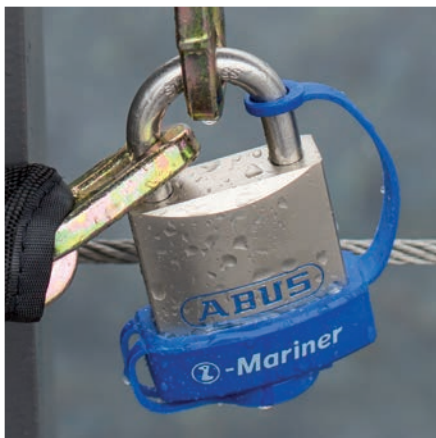
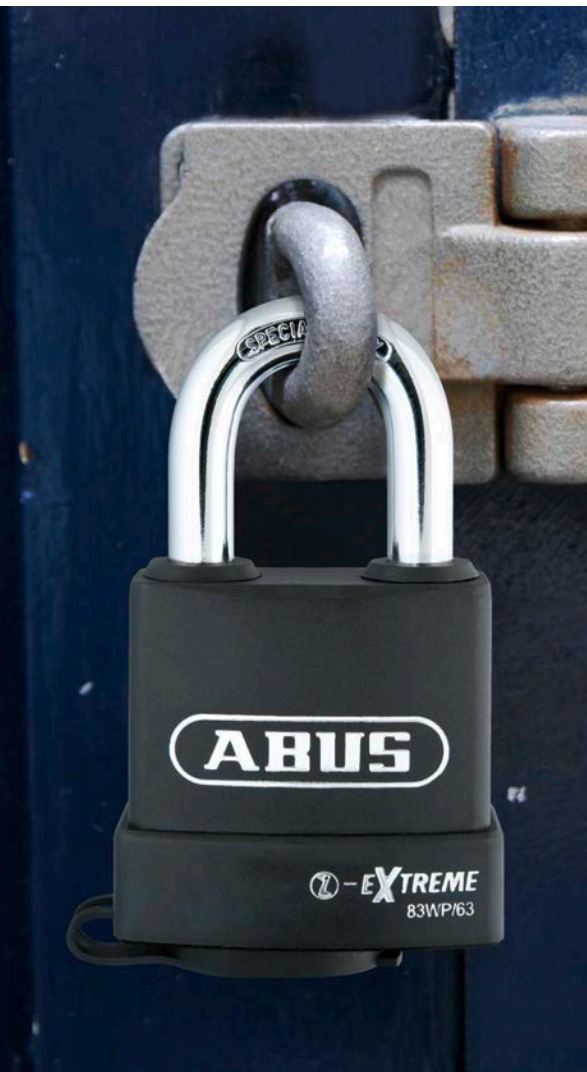



Combination

ABUS carries a wide range of combination padlocks that can be individually secured by a 3- or 4-digit number combination. Available in a variety of shapes, colors, and sizes.

DIAL COMBINATION 78

- 3-dial combination
- Extra protection against manipulation
- Hardened steel body
- Colored dial for individuality and easy recognition
- 78KC: Key Control - pin tumbler has master key function



Item	Body Width	Horizontal Shackle Clearance	Vertical Shackle Clearance	Shackle Diameter	Shackle Material	Case Pk Quantity
78/50 C	2"	7/8"	13/16"	1/4"	Steel	6
78KC/50	2"	7/8"	13/16"	1/4"	Steel	12

ALUMINUM COMBINATION 145

- Solid and lightweight aluminum body
- 3- or 4-digit individually resettable code
- Ideal for securing toolboxes, luggage, lockers, cabinets and more

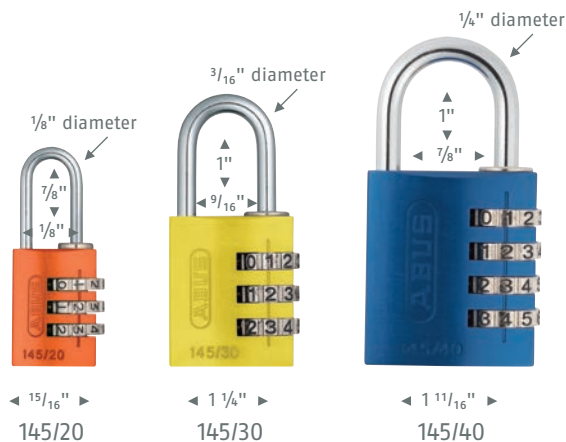

Item	Body Width	Horizontal Shackle Clearance	Vertical Shackle Clearance	Shackle Diameter	Dials	Shackle Material	Case Pk Quantity
145/20 C	15/16"	1/8"	7/8"	1/8"	3	Steel	6
145/30 C	1 1/4"	9/16"	1"	3/16"	3	Steel	6
145/40 C	1 11/16"	7/8"	1"	1/4"	4	Steel	6

TSA 147/148

- Individually resettable 3-digit code
- Visible red indicator at shackle: lock was opened by TSA
- To reset red indicator open lock and turn shackle by 360°



Item	Body Width	Horizontal Shackle Clearance	Vertical Shackle Clearance	Shackle Diameter	Dials	Shackle Material	Case Pk Quantity
147TSA/30 C	1 5/16"	3/16"	3/4"	1/8"	3	Steel	12
148TSA/30 C	1 5/16"	1 1/16"	1 7/16"	1/16"	3	Cable	12

BAKPAC™ 151

- Shackle diameter 1/8"
- Individually resettable 3-digit code
- Shackle opens by pressing the lever at the side

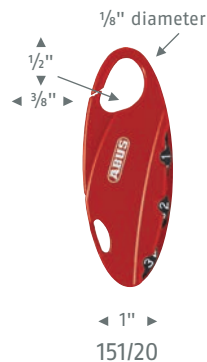

Item	Body Width	Horizontal Shackle Clearance	Vertical Shackle Clearance	Shackle Diameter	Dials	Shackle Material	Case Pk Quantity
151/20 C	1"	3/8"	1/2"	1/8"	3	Steel	12

COMBINATION 155

- Hardened steel shackle
- Individually resettable 4-digit code



Item	Body Width	Horizontal Shackle Clearance	Vertical Shackle Clearance	Shackle Diameter	Dials	Shackle Material	Case Pk Quantity
155/40 C	1 3/4"	3/4"	1 1/16"	1/4"	4	Steel	6

COMBINATION 158

- Solid body made of zinc die-cast
- Double bolted shackle
- Shackle made from hardened steel
- 158/40: individually resettable 3-digit code
- 158/45KC and 158/50: individually resettable 4-digit code
- 158/45KC: override key available for purchase



Item	Body Width	Horizontal Shackle Clearance	Vertical Shackle Clearance	Shackle Diameter	Dials	Shackle Material	Case Pk Quantity
158/40 C	1 5/8"	7/8"	1"	1/4"	3	Steel	3
158/50 C	2"	9/16"	1 5/16"	5/16"	4	Steel	3
158/45KC	1 3/4"	3/4"	1"	1/4"	4	Steel	12

COMBINATION 160

- Solid chrome-plated zinc body
- Hardened steel shackle
- Polished chrome finish for superior weather resistance
- 160/40: individually resettable 3-digit code
- 160/50: individually resettable 4-digit code



Item	Body Width	Horizontal Shackle Clearance	Vertical Shackle Clearance	Shackle Diameter	Dials	Shackle Material	Case Pk Quantity
160/40 C	1 5/8"	1 5/16"	7/8"	1/4"	3	Steel	6
160/50 C	2"	1 1/8"	1"	5/16"	4	Steel	6
160/50HB50 C	2"	1 1/8"	2"	5/16"	4	Steel	6



COMBINATION BRASS 180IB

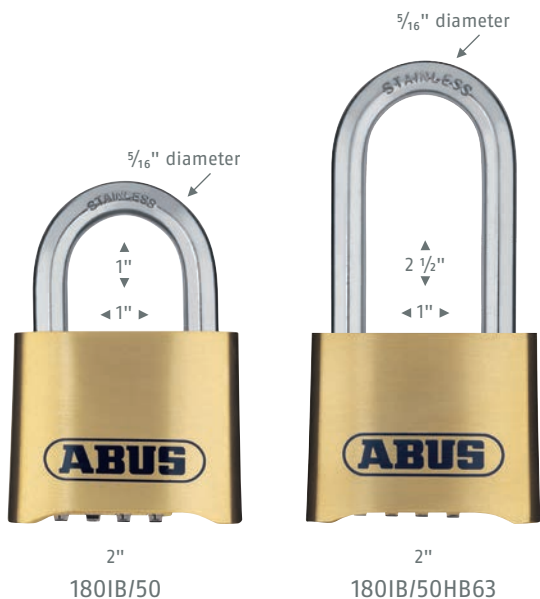

- Solid forged brass body provides superior protection and weather resistance
- Stainless steel shackle and corrosion-resistant inner components for ultimate rust protection
- Precision locking mechanism with special protection against manipulation
- 4-digit resettable code
- Resetting tool included



Item	Body Width	Horizontal Shackle Clearance	Vertical Shackle Clearance	Shackle Diameter	Dials	Shackle Material	Case Pk Quantity
180IB/50 C	2"	1"	1"	5/16"	4	Stainless	6
180IB/50HB63 C	2"	1"	2 1/2"	5/16"	4	Stainless	6

HEAVY DUTY COMBINATION 190



- Heavy-duty combination lock
- Solid hardened steel jacket
- 4-digit resettable code
- Precision locking mechanism with special manipulation protection
- Shackle guard protects shackle from attacks



Item	Body Width	Horizontal Shackle Clearance	Vertical Shackle Clearance	Shackle Diameter	Dials	Shackle Material	Case Pk Quantity
190CS/60 C	2 7/16"	7/8"	1 3/16"	7/16"	4	Steel	2

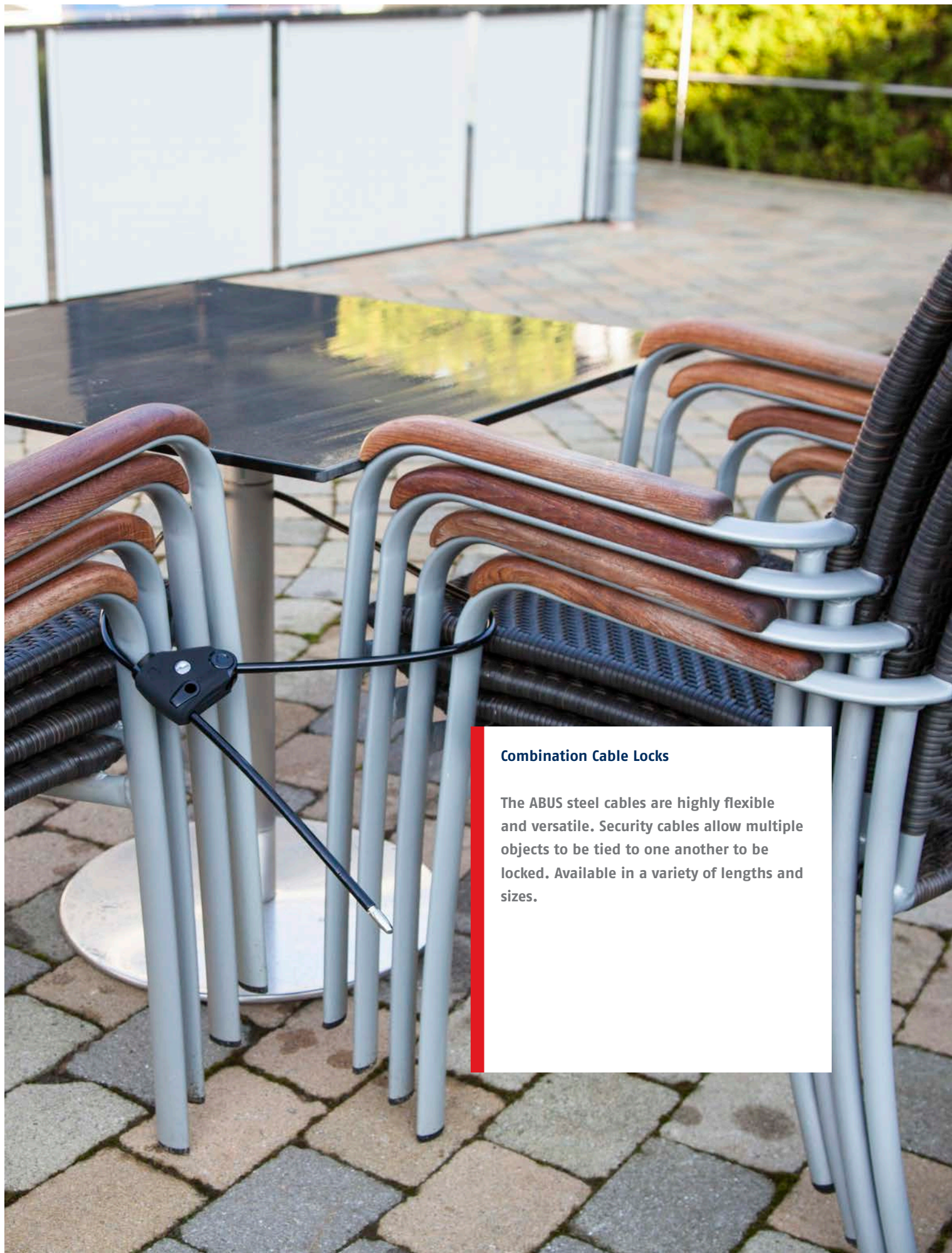

Combination Cable Locks

The ABUS steel cables are highly flexible and versatile. Security cables allow multiple objects to be tied to one another to be locked. Available in a variety of lengths and sizes.

COMBIFLEX CABLE LOCK



- 3-digit individual resettable code
- Braided steel, automatic roll up cable
- Light weight plastic case
- Fits perfect in every pocket or bag



Item	Part Number	Cable Length	Cable Diameter	Dials	Shackle Material	Case Pk Quantity
2501/65 C	12715	25"	$\frac{1}{16}$ "	3	Cable	3
2502/85 C	12716	33"	$\frac{1}{16}$ "	3	Cable	3

MULTILOOP CABLE LOCK

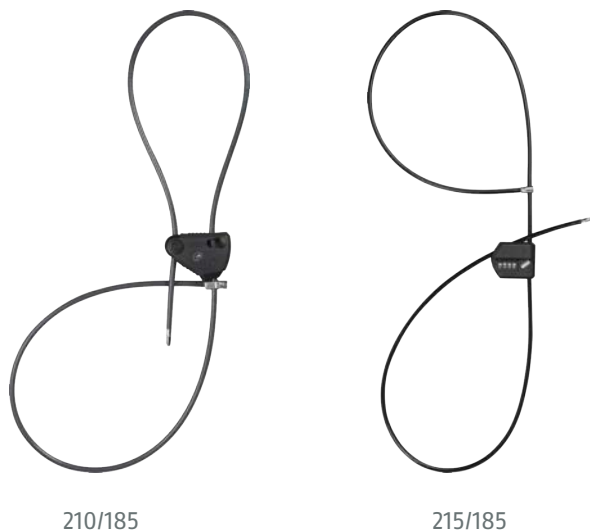

- $\frac{15}{16}$ " strong premium steel cable
- PVC-coating to prevent damage to surroundings
- Silicone coating on the lock body with "soft touch" properties for better grip
- Integrated adapter in the body for a conversion from one loop to a double-loop cable
- 210: Keyed, available keyed-alike or keyed-different
- 215: Combination

Item	Part Number	Cable Length	Cable Diameter	Dials	Cable Material	Case Pk Quantity
210/185 C	52524	36"	$\frac{3}{8}$ "	Keyed	Steel	1
215/185 C	58477	36"	$\frac{3}{8}$ "	4	Steel	1



KeyGarage™

The ABUS KeyGarage™ offers an intelligent and secure solution for storing keys. Secured by an individually set code, the strong steel plate housing protects keys and code cards against unauthorized users.

PUSH BUTTON KEYGARAGE™

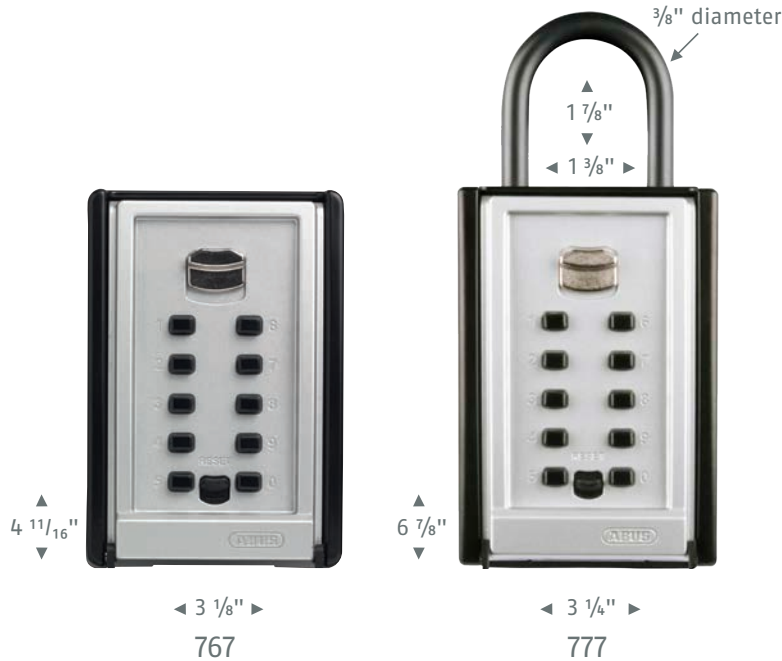

- Large solid metal housing offers more capacity than conventional key boxes
- 10 push-button resettable combination: Set your own PIN
- Push buttons provide faster access than dials
- Large hinged front door protects buttons
- 767: For wall mounting, 777: For attaching with shackle
- Holds up to 8 cards or 20 keys



Item	Part Number	Body Width	Body Height	Horizontal Shackle Clearance	Vertical Shackle Clearance	Shackle Diameter	Buttons	Case Pk Quantity
767 C	10767	3 1/8"	4 11/16"	-	-	-	10	1
777 C	10777	3 1/4"	6 7/8"	1 3/8"	1 7/8"	3/8"	10	1

MINI DIAL KEYGARAGE™



- Ideal protected storage for keys and other valuables
- Solid metal housing; locking cover made from zinc die-cast
- 4-digit individually resettable code
- Protective cover with sliding mechanism
- Holds up to 6 keys



Item	Part Number	Body Width	Body Height	Horizontal Shackle Clearance	Vertical Shackle Clearance	Shackle Diameter	Dials	Case Pk Quantity
737 C	10736	2 7/16"	5 3/16"	1 5/16"	2"	3/8"	4	1

DIAL KEYGARAGE™



- Ideal protected storage for keys and other valuables
- Solid metal housing; locking cover made from zinc die-cast
- 4-digit individually resettable code
- Protective cover with sliding mechanism
- 787: For wall mounting, 797: For attaching with shackle
- 787, 797: Holds up to 8 cards or 20 keys



Item	Part Number	Body Width	Body Height	Horizontal Shackle Clearance	Vertical Shackle Clearance	Shackle Diameter	Dials	Case Pk Quantity
787 C	10787	3 1/8"	4 11/16"	-	-	-	4	1
797 C	10797	3 5/16"	7 1/16"	1 7/16"	2"	3/8"	4	1



Hasps

ABUS offers a wide range of secure and versatile security hasps. The hardened steel loops conceal the shackle of the padlock, thus providing optimal protection against attempts to break the lock open.

INTEGRAL HASP D141



- Universal hasp with integrated Diskus® lock
- Ideal for use on double doors (utility vans, storage sheds)
- Easy to operate with one hand
- Solid metal locking case prevents successful attacks on the integrated padlock
- Zinc-plated for extreme corrosion resistance
- Mounting hardware included (screws, drilling template and spacers up to 1/5" height)
- Available with or without Diskus® lock



Item	Part Number	Body Width	Body Height	Body Material	Body Color	Case Pk Quantity
D141/200 C (w/26/70 Diskus)	01485	8 7/16"	3 1/8"	Steel	Black	13
D141/200 (Hasp only)	01485A	8 7/16"	3 1/8"	Steel	Black	13
D141/200 C (w/26/70 Diskus)	01486	8 7/16"	3 1/8"	Steel	White	13
D141/200 (Hasp only)	01486A	8 7/16"	3 1/8"	Steel	White	13

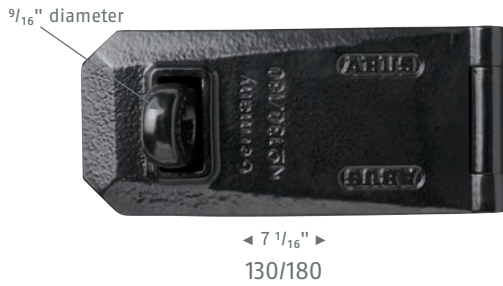

GRANIT™ HASP 130

- Two hardened hinge pins
- Tough white heart malleable iron
- Hardened staple
- Includes coach bolts and back plate



Item	Part Number	Body Material	Case Pk Quantity
130/180 C	01300	White Heart Malleable Iron	1

HARDENED STEEL HASP 125

- Extra-strong hinge
- Hardened staple
- Includes coach bolts and back plates
- Extremely high corrosion resistance

Item	Part Number	Body Material	Case Pk Quantity
125/150 C	01250	Coated Hardened Steel	3

Staple
Width: 5/8"
Height: 1/2"
Depth: 7/8"

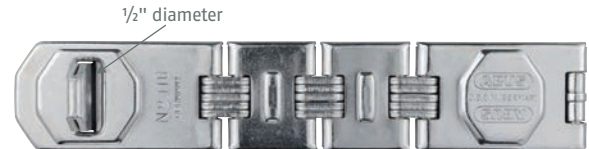

4 11/16" 140/120
7 3/8" 140/190 (shown)

6 1/8" 110/155
7 11/16" 110/195
9 1/16" 110/230 (shown)

STAINLESS STEEL HASP 140

- Hasp and hinge pins made of stainless steel
- Tough construction with hardened staple
- Hinge pins protected against attack
- Ideal in combination with Diskus® padlocks



Item	Part Number	Body Material	Case Pk Quantity
140/120 C	01481	Stainless Steel	3
140/190 C	01401	Stainless Steel	3

CONCEALED HINGE PIN HASP 110

- Hardened steel for extra strength
- Seamless eye loop prevents prying
- Center-lock pin resists being driven out at end
- Hidden screws and hinge pins for extra security



Item	Part Number	Body Material	Case Pk Quantity
110/155 C	01191	Hardened Steel	3
110/195 C	01101	Hardened Steel	3
110/230 C	01102	Hardened Steel	3

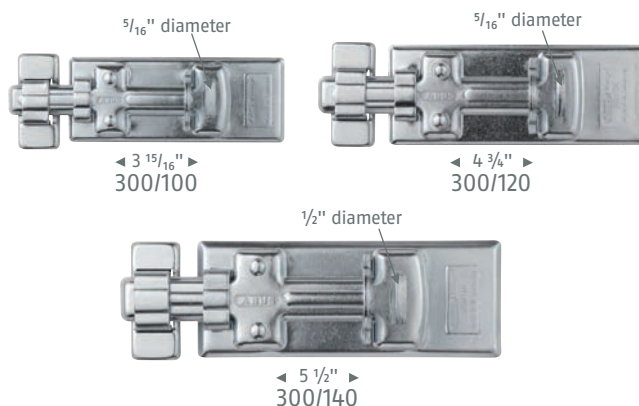

CONCEALED HINGE PIN HASP 100

- Hardened staple and hinge pins (not for 100/60)
- Concealed hinge pin
- Corrosion-protected
- Hidden screws



Item	Part Number	Body Material	Case Pk Quantity
100/60 C	01500	Steel	3
100/80 C	01501	Steel	3

HARDENED HASP 300

- Hardened steel sliding locking bolt
- Zinc chrome finish for corrosion protection
- Hidden screws for extra security



Item	Part Number	Body Material	Case Pk Qty
300/100 C	01550	Zinc-coated Hardened Steel	6
300/120 C	01551	Zinc-coated Hardened Steel	6
300/140 C	01552	Zinc-coated Hardened Steel	6

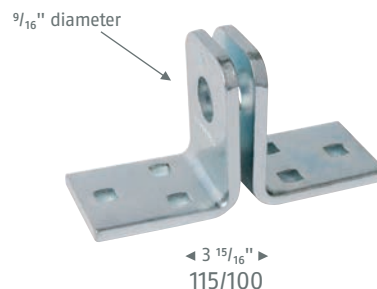
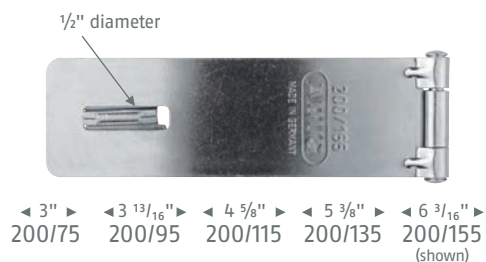

HARDENED HASP 200

- Hardened steel for extra strength
- Galvanized finish for corrosion protection
- Seamless eye loop prevents prying
- Hidden screws and hinge pins for extra security



Item	Part Number	Body Material	Case Pk Qty
200/75 C	02051	Hardened Steel	6
200/95 C	02061	Hardened Steel	6
200/115 C	02081	Hardened Steel	6
200/135 C	02091	Hardened Steel	6
200/155 C	02001	Hardened Steel	6

FIXED STAPLE HASP 115

- Corrosion-protected
- Hardened bolt
- Hidden screws



Item	Part Number	Body Material	Case Pk Qty
115/100 C	12701	Steel	3

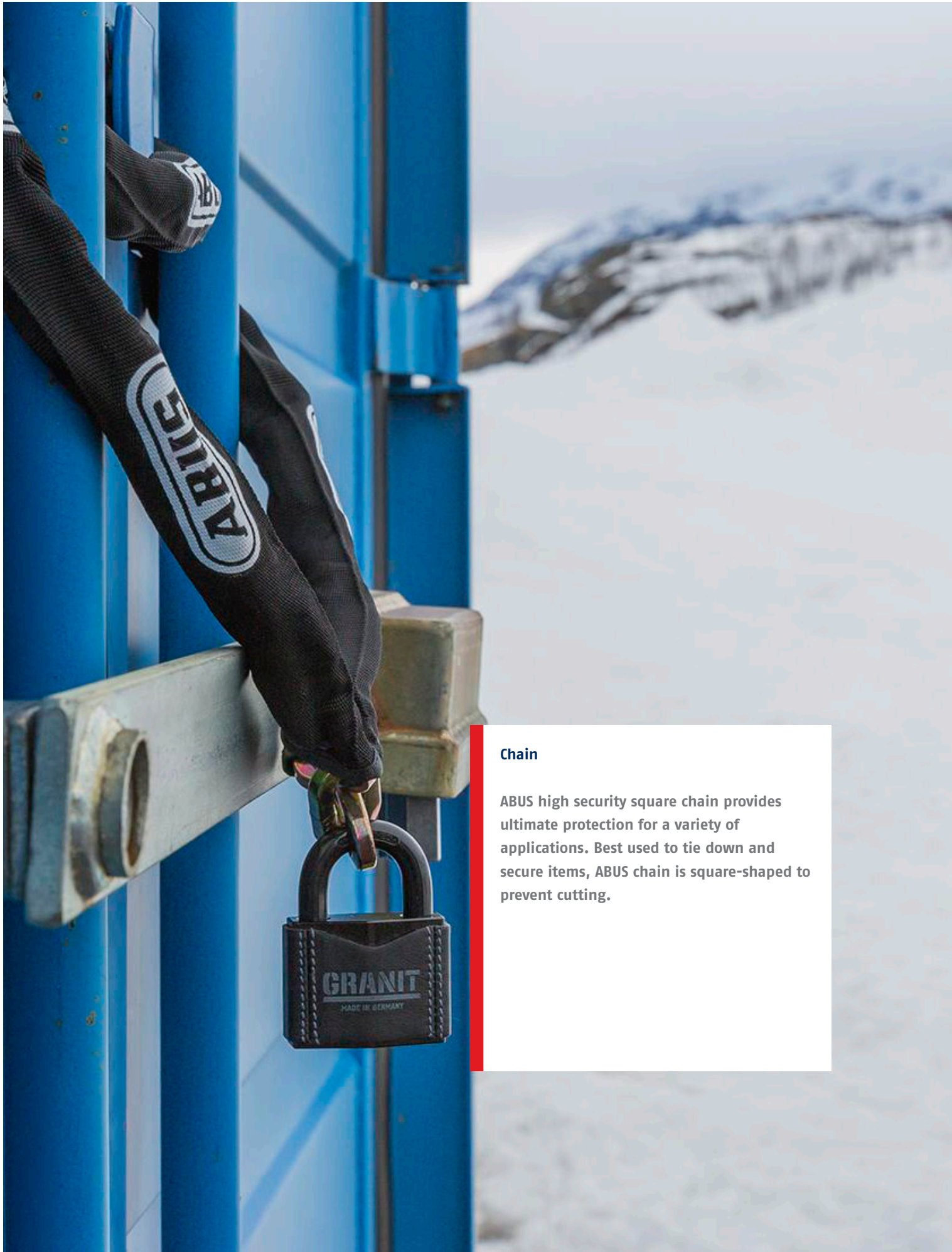

Chain

ABUS high security square chain provides ultimate protection for a variety of applications. Best used to tie down and secure items, ABUS chain is square-shaped to prevent cutting.

MAXIMUM SECURITY CHAIN

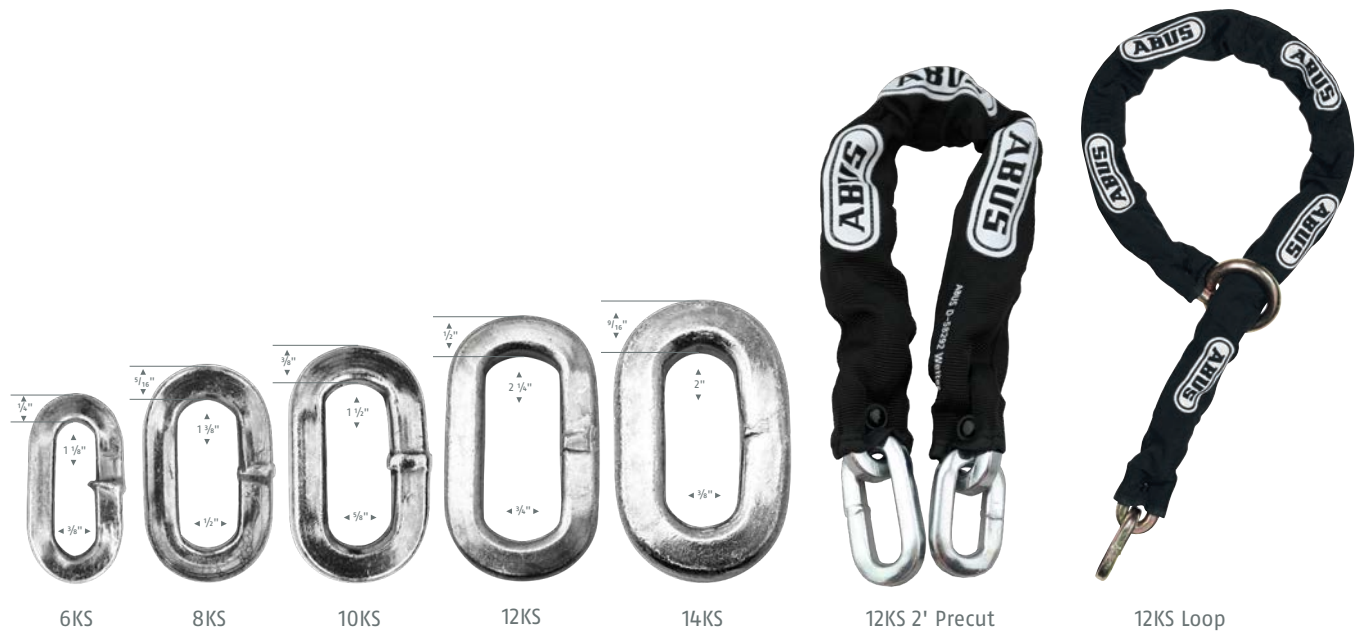

- Chain made from hardened steel
- Square-shaped links provide top security against all types of aggressive attacks
- Fabric sleeve on pre-cut chain lengths prevents surroundings from damage
- Available in pre-cut (2', 6', 10') or custom lengths
- 12KS loop chain comes with a larger loop on one end, making the chain go further

Item	Cutting Force	Inside Height	Thickness	Inside Width	Case Pk Quantity
6KS	4 tons	1 1/8"	1/4"	3/8"	1
8KS	6 tons	1 3/8"	5/16"	1/2"	1
10KS	8 tons	1 1/2"	3/8"	5/8"	1
12KS	10 tons	2 1/4"	1/2"	3/4"	1
14KS	12 tons	2"	9/16"	3/4"	1
12KS Loop 2.5'	10 tons	2 1/4"	1/2"	3/4"	1
12KS Loop 4'	10 tons	2 1/4"	1/2"	3/4"	1
12KS Loop 5'	10 tons	2 1/4"	1/2"	3/4"	1

COBRA STEEL CABLE

- Flexible steel cable
- ABUS loop cables protect bike components like front and rear wheel, frame and seat as the ideal complement to the ABUS U-shackle-locks, padlocks or frame locks
- Ideal to secure bicycles, surf boards, garden tools, etc.



10/500 Cable

Item	Part Number	Diameter	Length	Body Material	Case Pk Quantity
8/200 Non-Coiled C	12701	5/16"	78 3/4"	Steel	1
8/250 Non-Coiled C	12711	5/16"	98 7/16"	Steel	1
10/500 Non-Coiled C	12713	3/8"	196 13/16"	Steel	1
10/1000 Non-Coiled C	12714	3/8"	393 11/16"	Steel	1
1850/185 Coiled B	12702	5/16"	72 13/16"	Steel	1



FLOOR AND WALL ANCHOR



◀ 6 1/2" ▶

WBA100

- 6 ⁵/₁₆" shackle made of hardened steel for extreme resistance against the most aggressive attacks
- Extra wide shackle for easy locking
- Due to its flat shape and the use of high-quality plastic, it is possible to drive over the anchor in fixed position
- Can be used indoors and outdoors as wall or floor anchor
- Includes mounting hardware

Item	Part Number	Case Pk Quantity
WBA100	03303	1

WALL ANCHOR



◀ 4 1/3" ▶

WA50

- Hardened steel wall anchor
- Can be used indoors and outdoors
- Includes hardware for wall or floor mounting

Item	Part Number	Case Pk Quantity
WA50	03300	1



File Cabinet Bars

ABUS File Bars provide the best solution for securing multi-drawer filing cabinets by restricting access to sensitive data stored inside. Available in for file cabinets with 1 to 5 drawers.

FILE CABINET BARS



1-Drawer



2-Drawer



3-Drawer



4-Drawer



5-Drawer

- Constructed of 16-gauge steel
- Conveniently located knob allows easy and smooth operation
- Reversible for left and right side mounting
- Available in five different lengths
- Built-in spring-loaded hinge
- Mounting screws included
- Meets the DOD's Industrial Security Requirements

Item	Part Number	Width	Length	Case Pk Quantity
1-Drawer	07010	1 3/8"	12 1/4"	10
2-Drawer	07020	1 3/8"	22 1/2"	10
3-Drawer	07030	1 3/8"	34 7/16"	10
4-Drawer	07040	1 3/8"	45 13/16"	10
5-Drawer	07050	1 3/8"	56 3/4"	10

ICON GLOSSARY



100% RUST-FREE

All parts of the lock are made from non-corrosive materials



CORROSION RESISTANT

Highly corrosion resistant due to surface protection



PARACENTRIC KEYWAY

Resists professional picking by special key profile



DRILL PROTECTION

Cylinder is protected against drilling and leverage



BOLT CUTTER PROTECTION

Bolt cutter attack resistant



SAW RESISTANT

Saw attack resistant



HAMMER RESISTANT

Hammer & impact attack resistant



HARDENED SHACKLE

Shackle made from hardened steel



CORROSION PLATING

Sophisticated plating for extreme corrosion resistance



ALUMINUM ALLOY

Lock body made from special aluminum alloy - light but secure



GERMANY

Development and production in Germany



SHACKLE GUARD

Shackle access restricted, protecting shackle from attack



STEEL BALL LOCKING

Solid steel ball locking



DOUBLE-BOLTED

Both sides of the shackle are secured by bolts or balls – increased protection against attacks and manipulation



SELF-LOCKING

The lock is locked automatically by pushing down the shackle – no key needed for locking



KEY-RETAINING

A key is needed for locking. Lock retains key until locked



RK AVAILABLE

Cylinder can be taken out and can be rekeyed to match an existing key



KA AVAILABLE

Available keyed-alike (several locks with the same key)



MK AVAILABLE

Available master-keyed (one key opens many different locks)



RESETTABLE CODE



ABUS-PLUS

Original ABUS-Plus disk cylinder – highest precision, highest security



DIMPLE KEY

No sharp edges and can be inserted either way up



LED KEY



CODE CARD

Spare keys are made only upon presentation of Code Card



SAMPLE KEY AVAILABLE

New locks can be made up to a sample key



UL VALIDATED



SUSTAINABLE SOLUTIONS

GLOSSARY



BODY MATERIAL

AL = Aluminum
IB, ST = Stainless Steel
M, MB = Brass
TI = Titanium

SHACKLE MATERIAL

MB = Brass
PS = Plastic
CAB = Cable

SHACKLE LENGTH

CS = Closed Shackle
HB 25 = 1"
HB40 = 1 1/2"
HB50 = 2"
HB63 = 2 1/2"
HB75 = 3"
HB100 = 4"

KEYING

KD = Keyed Different
KA = Keyed Alike
KC = Key Control
MK = Master Key
GMK = Grand Master Key
RK = Rekeyable
IC = Interchangeable Core

CUSTOM SAFETY KIT ORDER FORM

Company:		Attention:	
Address:			
City:	State:	Postal Code:	
PO #:	Date:		

Please indicate the quantity and color of each item requested

SELECT POUCH OR TOOLBOX:

B100 Small Pouch

B102 Large Pouch

B200 Toolbox



SELECT DEVICE(S):

Lockout/Tagout Hasp

ST0701 - 1" Hasp:

ST0702 - 1½" Hasp:

ST0801 - 1" Hasp (with Tab):

ST0802 - 1½" Hasp (with Tab):

Lockout Tags

T100 - DO NOT OPERATE:

T102 - OUT OF SERVICE:

Gate Valve Lockout

V303 - Fits Gate Valve 1 - 2½":

V305 - Fits Gate Valve 2½ - 5":

Compressed Air Lockout

P603:

V500 Universal Valve Lockout

87151:

Breaker Lockout

E201 Single-Pole Breaker Lockout:

E202 Multi-Pole Breaker Lockout:

Plug/Forklift/Cylinder Lockout

00457:

Electric Panel Handle Lockout

00456:

Oversize Push Button Lockout

00455:

SELECT PADLOCK(S):

	RED	BLUE	GREEN	YELLOW	ORANGE
Aluminum 72/40					
1½" Shackle:					
3" Shackle:					
Cable Aluminum 72/30CAB					
4":					
8":					
Laminated Steel 41/40					
1½" Shackle:					
3" Shackle:					
Insulated Aluminum 74/40					
1½" Shackle:					
3" Shackle:					
3" Body & 1½" Shackle:					
Insulated Brass 74M/40					
1½" Shackle:					
3" Shackle:					
3" Body & 1½" Shackle:					
Silver Rock™ 5/50HB25					
	Keyed-Different #62795		Keyed-Alike #550001		
1½" Shackle:					

Ball Valve Lockout

V442
Max Handle Thickness 25/64",
Max Handle Width 29/32":

V423
Max Handle Thickness 9/32"
Max Handle Width 1 25/64":

Switch Lockout

E250:

Power Plug Lockout

P110 - 3½ x 3 3/16":

P550 - 6 5/16 x 4 9/16":

	3'	6'	9'	15'
Safelex™ Universal Cable Lockout:				
Standard Cable Lockout:				

KEY BLANKS

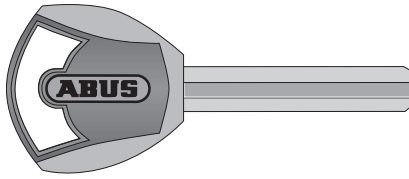

90040 ABUS PLUS
Works with: 20, 37, 88

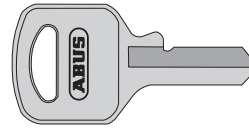

90130
Works with: 55/25, 54TI/25

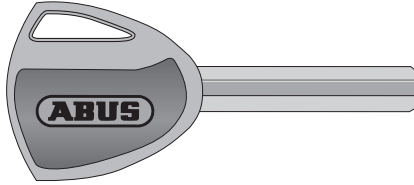

90042 ABUS PLUS LED
Works with: 20, 37, 88

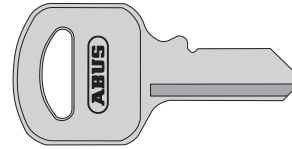

90140
Works with: 55/30, 54TI/30

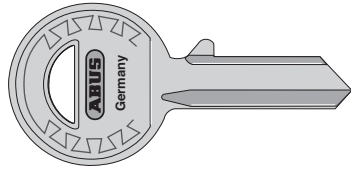

KBR: 90010, KBL: 90020
Works with: 24IB/(50, 60, 70) 28/70KA, 41/(30, KA/MK 4-pin)

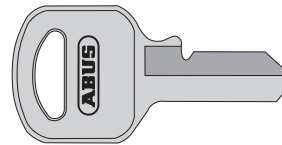

90140
Works with: 55/35, 54TI/35

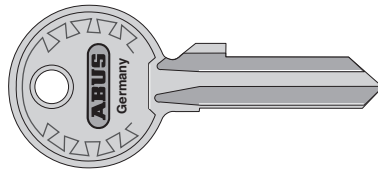

KBR: 90015, KBL: 90016
Works with: 24IB/70KD, 24RK, 26, 28/70, 41KD 5-pin

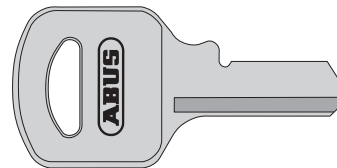

90150
Works with: 55/40, 54TI/40

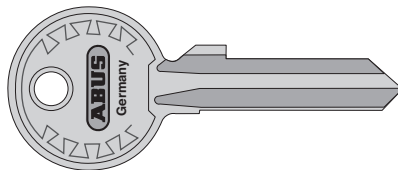

KBR: 90420, KBL: 90430
Works with: 24, 26, 82/(62, 70), 92/65 5-pin

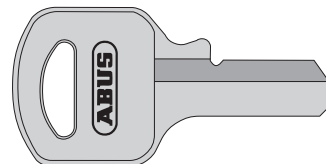

90160
Works with: 55/45, 54TI/45

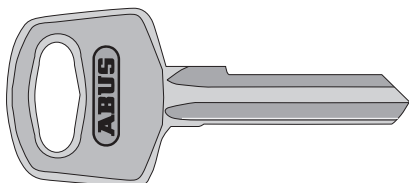

90018
Works with: 72/40, 74

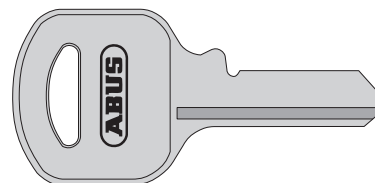

90170
Works with: 55/50, 54TI/50

KEY BLANKS

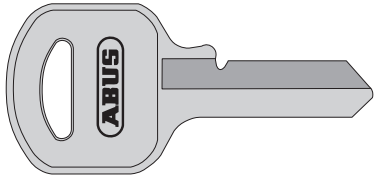

90180

Works with: 55/60, 54TI/60

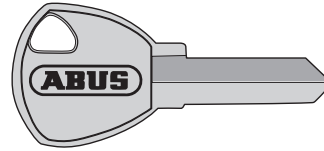

90233

Works with: 65/30 + 35, 64TI/30 + 35 New

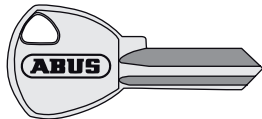

90184

Works with: 64TI/25

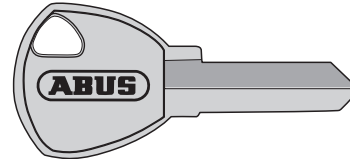

90240

Works with: 65/40 + 45 Old

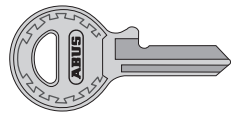

90200

Works with: 65/15 R

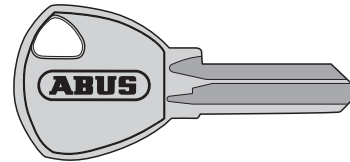

90243

Works with: 65/40 + 45, 64TI/40, T65, 70, 70AL

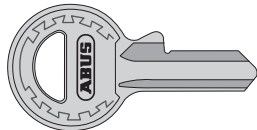

90215

Works with: 65/20

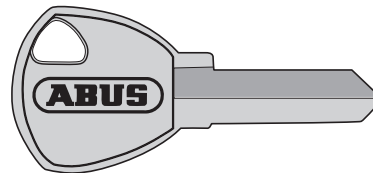

90250

Works with: 65/40 + 45, 64TI/40, T65, 70, 70AL

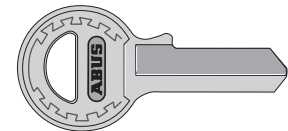

90220

Works with: 65/20

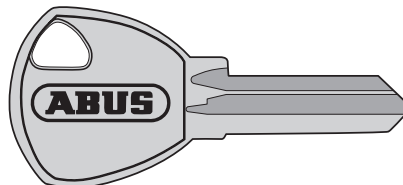

90183

Works with: 65/50 + 60, 64TI/50 + 60

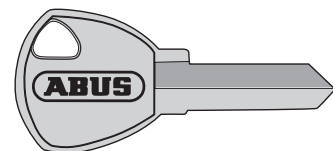

90230

Works with: 65/30 + 35 Old

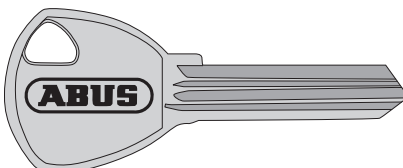

90186

Works with: 80TI/40 + 50

KEY BLANKS

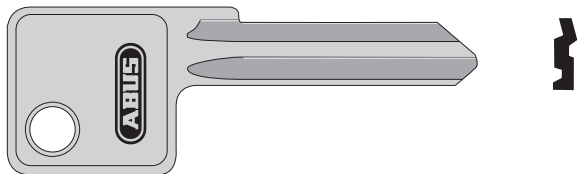

83618A

Works with: 83 Series - #100 Yale No. 8

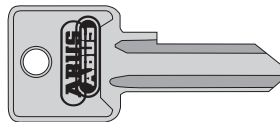

90390

Works with: 85/20 + 25 R

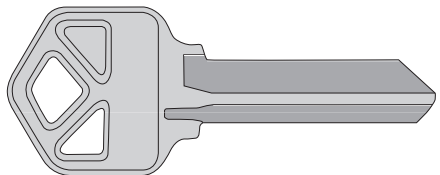

83016

Works with: 83 Series - #200 Kwikset

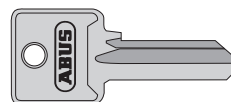

90380

Works with: 85/20 + 25 L

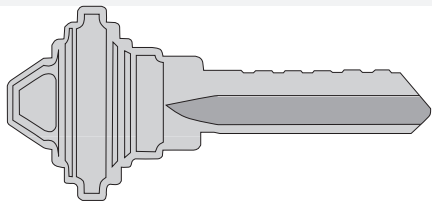

83017A

Works with: 83 Series - #300 Schlage

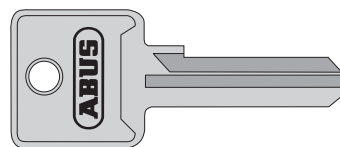

90400

Works with: 85/30 L

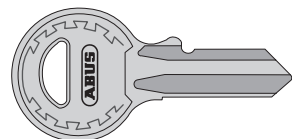

90330

Works with: T84MB/30 R

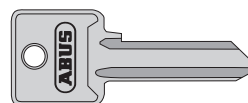

90410

Works with: 85/30 R

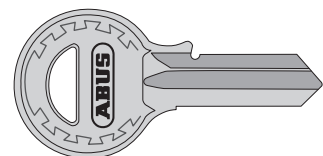

90340

Works with: T84MB/40 L

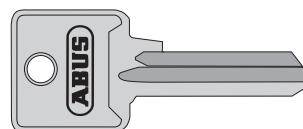

90420

Works with: 85/40 L, 82/63 + 70

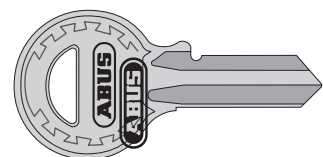

90350

Works with: T84MB/40 R

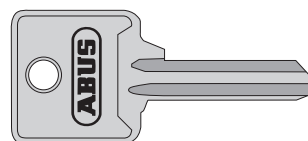

90430

Works with: 85/40 R, 82/63 + 70

KEY BLANKS

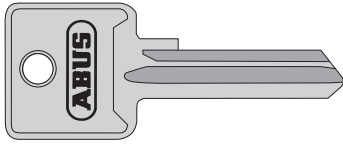

90440

Works with: 85/50+60 L, 82/90

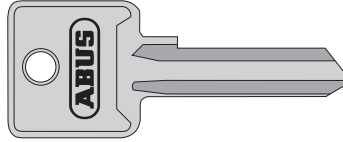

90450

Works with: 85/50+60 R, 82/90, 92/80

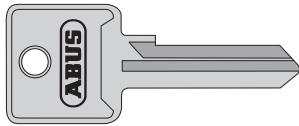

90590

Works with: 85/70 L

INDEX

Item	Page Number
5/50 Silver Rock™	49
20 High Security Diskus®	51
24IB Waterproof Diskus®	51
25 Dimple Key Diskus®	52
26 Stainless Steel Diskus®	52
28 Hardened Steel Diskus®	53
37[RK]/55 Granit™	55
37ST/55 Granit™	55
37[RK]/60 Granit™	56
37RK/70 Granit™	56
37RK/80 Granit™	56
41 Laminated Steel	59
55 Traditional Brass	61
54TI Titanium™	69
64TI Titanium™	70
65 Traditional Brass	62
70 Weatherproof Brass	64
70IB Weatherproof Brass	64
72 Safety Aluminum	9
74 Insulated Safety	11
75IB Weatherproof Brass	64
76 High Security Safety	13
78 Dial Combination	81
80TI Titanium™	69
82 Brass Monoblock	67
83 Titanium™	74
83 Brass	74
83 Hardened Steel LFIC	75
83 Professional Plated	75
83 Steel Rock	76
83 Weatherproof	77
83 Interchangeable Core	78
84IB Weatherproof Brass	65
T84MB Safety Brass	15
T84MB Weatherproof Brass	65
85 Brass	63
88 Brass	63
92 Steel Monoblock	67
93 Steel Rekeyable Monoblock	67
145 Aluminum Combination	81
147TSA/148TSA Combination	82
151 Bakpac™ Combination	82
155 Combination	83
158 Combination	83
160 Combination	84
180IB Brass Combination	85
190 Heavy Duty Combination	85
Anchor, Floor and Wall	99
Anchor, Wall	99
Cable, Cobra	98
Cable, Combiflex	87
Cable, Multiloop	87
Chain	97

INDEX

Item	Page Number
File Cabinet Bar	101
Hasp, 100 Concealed Hinge Pin	95
Hasp, 110 Concealed Hinge Pin	94
Hasp, 115 Fixed Staple	95
Hasp, 125 Hardened Steel	94
Hasp, 130 Granit™	94
Hasp, 140 Stainless Steel	94
Hasp, 200 Hardened	95
Hasp, 300 Hardened	95
Hasp, D141 Integral	93
KeyGarage™ 737 Mini Dial	90
KeyGarage™ 767 Push Button	89
KeyGarage™ 777 Push Button	89
KeyGarage™ 787 Dial	91
KeyGarage™ 797 Dial	91

SAFETY DEVICES

B810 Permit Redbox™	23
B835 RED Safety Redbox™	21
C503-C515 Safelex™ Cable Lockout	25
C553-C565 Standard Cable Lockout	25
E201 Single-Pole Circuit Breaker Lockout	35
E202 Multi-Pole Circuit Breaker Lockout	35
E250 Wall Switch Lockout	37
Forklift/Plug Lockout	36
Hasp, AL0701-AL0702 Aluminum Lockout/Tagout	18
Hasp, Aluminum Labeled	19
Hasp, Butterfly	19
Hasp, H770 Plastic Lockout/Tagout	18
Hasp, ST0701-ST0702 Steel Lockout/Tagout	17
Hasp, ST0801-ST0802 Steel Lockout/Tagout	17
Lockout Cabinets	44
Lockout Labels	39
Lockout Stations	44
P110-P550 Power Plug Lockout	36
P606 Gas Cylinder Lockout	30
P603 Compressed Air Lockout	30
P625 Plug and Hoist Lockout	37
Padlock Stations	45
Panel Handle Lockout	38
Push Button Lockout	38
Safety Kits	42
T100-T200 Lockout Tags	39
Tags on a Roll	41
ULC100 Water Fountain Lockout	33
V303-V313 Gate Valve Lockout	29
V423-V426 Metal Ball Valve Lockout	28
V442-V448 Plastic Ball Valve Lockout	28
V500 Universal Valve Lockout	27

INFORMATION AND CONDITIONS

STANDARD TERMS & CONDITIONS

ABUS USA, LLC ("ABUS"), a division of the ABUS Group and all of its subsidiaries and related companies (future or currently existing) reserve the right to refuse an order, in its entirety or in part, when the credit of the Purchaser is judged not to be satisfactory in our absolute discretion. Furthermore, ABUS and its affiliates may refuse an order when the type or quantity of goods being requested does not conform to our ordering specifications.

The following conditions and terms incorporated herein constitute the entire agreement between the parties. Sales quotations, sales quotation requests, purchase orders or other forms of acknowledgment issued by the Purchaser that have contradictory terms and conditions do not bind ABUS or its affiliates to any other terms and conditions beyond those encompassed in this agreement. Only with separate written agreements written by ABUS or its affiliates and authorized by an ABUS representative may alternative terms and conditions be considered or referenced.

When ABUS accepts the Purchaser's purchase order, the Purchaser agrees that they accept the terms and conditions as described in this agreement regardless of the terms and conditions that may be specified in the Purchaser's purchase order. In the event when the Purchaser's purchase order terms and conditions and the terms and conditions specified in this agreement conflict, the Purchaser's terms and conditions will be disregarded and denied and the Purchaser agrees that this agreement shall constitute the entire agreement between the Purchaser and ABUS. In the event or circumstance that the enforcement of the terms and conditions of this agreement hereof is not conducted by ABUS or any other instrument, document, or alternative agreement relating to the goods being sold, such lack of enforcement will not waive, affect or reduce any right of ABUS in the future to require/enforce strict performance of such terms and agreements.

PRICES

All prices are subject to change without advance notice and are not guaranteed. All orders received by ABUS are deemed submitted at applicable prices in effect at the time of shipment pursuant to the terms and conditions outlined below. Possession of this catalog, ABUS Price List or other officially authorized ABUS documents, sales literature, catalogs does not constitute an agreement to sell. We reserve the right to correct clerical and other types of errors at any time. All prices are stated in US dollars.

TERMS

Decisions concerning the extension of trade credit are made by ABUS in its absolute sole discretion. Distributors/Purchasers who satisfy ABUS' ordinary credit criteria will be able to purchase products from ABUS at Net thirty (30) days. A service charge of 1% per month shall be imposed on the unpaid balance of any delinquent invoices. COD or Cash in Advance orders do not qualify for any term discounts. Furthermore, the Customer/Distributor/Purchaser shall be responsible for costs involving collections, court cost and or attorney's fees in association with the recovery of any overdue amounts.

RETURNED CHECKS

NSF checks will be charged a \$30 returned check fee. Returned checks are required to be paid by money order, cashier's check, or credit card. ABUS reserves the right to revoke open terms and change the account to Credit Card Required if we receive more than two returned checks for an account in any 90 day time period.

CREDIT HOLD POLICY

ABUS reserves the right to hold orders for any account that is past due.

STATE RESALE TAX CERTIFICATE

ABUS is required by law to have a valid resale tax certificate on file for each customer that makes a tax-exempt purchase. It is very easy to confuse the Resale Tax Certificate with a sales tax license, registration, or resellers permit number. The Resale Tax Certificate applies to the purchase(s) of goods for resale and proves that sales tax does not need to be collected; the purchaser must collect sales tax when the goods are resold. There are state specific laws that must be followed. Unfortunately, there is no one form that can be used in all states. ABUS must have a Resale Tax Certificate for each dealer for each state, and may have multiple Resale Tax Certificates for a customer. Some Resale Tax Certificates expire, so ABUS must monitor the validity and be certain that Resale Tax Certificates on file are current.

ACCOUNT CHANGES

For your protection, any changes to your business such as name, address, phone/fax number, contact personnel, or ownership must be submitted to ABUS in writing by a principal and then sent via fax or USPS to us.

CHANGES & CANCELLATIONS

Changes to or cancellations of orders must be made in writing and delivered by email, fax or regular mail. Cancellations made after ABUS has issued an order acknowledgment are subject to ABUS approval, and are subject to a \$25 processing fee in addition to any cost incurred by ABUS as a result of the original order.

QUOTATIONS

If and when ABUS chooses to provide an official sales quote, the quote will be valid for thirty (30) days. Complete shipment of the order must be accepted by the Purchaser within six (6) months from the date of issuance. Sale quote numbers (SO #'s) and possible project names must be referenced on the order. The sales quote is considered null and void if the Purchase Order does not reflect all of the product lines on the original sales quote or if the quantities for an item found in the quote deviate fifteen (15) percent or more. The Purchaser must request a new quotation.

Amendments, changes or modifications to an original sales quote will be accepted for up to thirty (30) days from the date of the original quote. All modifications must reference the original sales quote number. With the acceptance of the sales quote for the purchase of products, the Purchaser agrees that the products or services being purchased will not be resold or transferred to any distributor not sanctioned/authorized by ABUS to sell its products. This includes all branches and affiliates of the distributor. Failure to adhere to this restriction may result in the distributor's loss in eligibility for quotes or services at ABUS' sole discretion.

FREIGHT POLICY

ABUS will prepay freight on deliveries to customers provided the following conditions are met (customers in Alaska, Hawaii, Puerto Rico, and Canada are excluded and should contact ABUS USA, LLC for information regarding applicable freight charges):

1. The order must be for a minimum of \$750 to qualify for prepaid freight.
2. Payment of invoices is within terms. (i.e. freight will not be prepaid on orders to customers with past due invoices).
3. ABUS reserves and shall have the absolute right to select and employ the most economical carrier. If the customer specifies routing that results in higher freight costs, then ABUS' invoice will include the difference, which the customer agrees to pay.
4. All shipments are FOB (Freight On Board) ABUS US, Phoenix, AZ. Title of goods passes to customer upon delivery thereof by ABUS to the carrier or delivery service. Thereupon, the purchaser assumes fully the risk of loss.

CLAIMS

All claims for shipping and/or invoicing differences must be submitted within 10 days of receipt of shipment. Upon delivery to or pickup by the carrier, title passes and shipments become the property of the customer.

The customer assumes the risk of and makes claims for any loss, shortage or damage in transit.

RETURNS

Requests to return ABUS products should be made within 10 days from date of order and ABUS reserves the right to request date of manufacture and other product information. On goods returned for customer convenience, ABUS requires product be in new, resellable condition and in the original, unaltered packaging.

An RMA (Return Material Authorization) must be obtained from authorized personnel of ABUS before any product may be returned. RMA number must be clearly marked on the outside of the return package. Upon inspection by ABUS, a decision will be made to issue a credit for the ABUS product. This decision will be made solely by ABUS in accordance with the provisions of these Terms. Merchandise returned to ABUS in original unopened cartons is subject to a 15% restocking fee. Merchandise returned in an unsellable state (damaged blisters, product cards etc.) will be subject to an additional 20% repackaging fee.

Obsolete products will not be accepted for return. Transportation charges and insurance on all returned materials must be prepaid by the purchaser.

On goods returned for customer convenience, when the purchaser returns materials in compliance with these Terms which are accepted by ABUS, the purchaser may be issued a credit for 85% of the purchase price, with 15% charged by ABUS for handling and reprocessing.

Refused Orders – Orders refused for any reason will be charged a 15% restocking fee and all applicable freight costs incurred by ABUS will be charged to your account.

All refunds will be in the form of a merchandise credit, no cash refunds will be given.

Custom Pinning/Keying orders will be assessed a 25% re-stocking fee. All engraved locks are non-refundable.

FULL WARRANTY

This warranty gives you specific rights, and you may have other rights which vary from state to state. This warranty applies to ABUS brand products only.

If an ABUS product fails to work properly due to a manufacturing defect, return it to ABUS postage prepaid, and we will return it repaired or replaced at our discretion. To obtain warranty service, please call 800.352.2287 or simply return the padlock prepaid along with receipt of purchase and all parts and keys if applicable to:

ABUS USA LLC
23910 N. 19th Ave., #56
Phoenix, AZ 85085-1850

ABUS products are warranted for a specific period of time from date of purchase. Commercial products are warranted for 2 years against manufacturing defects and ABUS reserves the right to replace or repair the product at its discretion. ABUS will return the repaired or replaced product to the original purchaser.

All products sold under the Vitesse™ High Security Cylinder line will have a limited two (2) year warranty from the time that the original goods were transferred from the Purchaser. ABUS Vitesse™ high security keys will have a lifetime warranty against manufacturing defects and breakage.

REQUIREMENTS FOR COMBINATED AND UNCOMBINATED VITESSE™ PRODUCTS:

1. Keys shall be cut to the ABUS Vitesse™ specifications required for the particular keyway and depth system and be original key blanks made by ABUS.
2. All pin lengths shall be selected according to prescribed ABUS Vitesse™ requirements.
3. Original ABUS Vitesse™ brand cylinders and cylinder components, including pin tumblers and key blanks, shall be used. We reserved the right to void any warranties or claims for warranty on the basis of using products or components that are not produced by ABUS USA, LLC or its affiliated ABUS sister companies.
4. ABUS will not pay for the cost of the repair performed, reinstallation or new installation of a new or existing keying systems or products. Furthermore, ABUS cannot be held liable for any related fees, loss of use or perceived loss of use or any other associated issues in terms of a warranty claim on the ABUS Vitesse™ keying system. Written notice of a product or component part believed to be defective as covered by this warranty should be sent to ABUS and should include your name and address, an identification of the product or component part and a brief description of the defect. Upon receipt of such notice, ABUS will inform where to ship the product or component with prepaid shipping for inspection and in the event such inspection reveals a defect covered by this warranty, the product will be repaired and or replaced. ABUS and its affiliates reserve the right to replace products covered by this warranty that may be discontinued with what we deem as a suitable equivalent.

LIMITATION ON LIABILITY

To the extent permitted by law, ABUS and its agents and affiliates (collectively "ABUS Parties") shall not be responsible for, and the purchaser hereby assumes the risk of, and hereby releases ABUS for any damages or injury whatsoever (including, without limitation, incidental or consequential damages, damages for lost profits or business interruption, and punitive damages) caused by or related to any use of ABUS Products, regardless of any error, omission, interruption, defect, failure of performance, delay in operation or transmission, even if ABUS has been advised of the possibility of such damages. If, notwithstanding the foregoing limitations, ABUS has any liability to the purchaser despite the foregoing limitations, the purchaser agrees that the ABUS' total liability to the purchaser for all losses, damages, and causes of action, whether in contract, equity, tort (including without limitation, negligence and gross negligence), or otherwise, will not exceed the amount the purchaser paid to ABUS for the ABUS products. Any action or arbitration brought against the ABUS pertaining to or in connection with the ABUS Products must be commenced and served upon ABUS within one (1) year after the date the cause of action arose, and not thereafter. Failure to abide by such deadline will constitute a complete defense for the ABUS Parties to the purchaser's claims.

NO THIRD PARTY LIABILITY

If the purchaser uses the ABUS Products on behalf of others or provides to others any products referenced herein, the ABUS Parties shall have no liability to such persons whatsoever, and the purchaser agree to defend and indemnify the ABUS Parties from any and all claims and demands asserted against them, and from any legal fees, costs and other expenses that the ABUS Parties incur therewith.

GOVERNING LAW & JURISDICTION

These Terms are governed by the laws of the State of Arizona, U.S.A. but without regard to its principles of conflict of laws. For any interpretational disputes relating to, or claims arising from, these Terms, the purchaser agrees to the exclusive jurisdiction of the Superior Court of Arizona in Maricopa County, provided, however, that such restriction shall not apply to legal actions initiated or brought by ABUS. Upon request by ABUS, all disputes concerning and claims arising from the foregoing shall be referred to binding arbitration in Maricopa County, Arizona by an arbitrator selected only by the Superior Court of Arizona in Maricopa County. The purchaser hereby waives its right to a jury with regard to claims against the ABUS Parties hereunder. The language used in these Terms shall not be construed.

GLOBAL EXPERTISE



ABUS Global Headquarters
and Training Center
Wetter, Germany



- ABUS Branch Office
- ABUS Partner



ABUS
SINCE
1924

97

YEARS OF INNOVATION

FAMILY- OWNED SINCE 1924

From the beginning, when August Bremicker and his sons first manufactured traditional padlocks in 1924, the course was set for an ambitious goal: to become the global brand for security. ABUS's expertise in security was and still is founded on a comprehensive product range offering fundamental mechanical security and safety technology.

Decades later, ABUS realized a need for workplace safety which fit hand-in-hand with its long-standing history as a global leader in security. The addition of high-quality lockout tagout padlocks, devices, and accessories has allowed ABUS to expand its product offerings and global expertise into the industrial safety sector.

From home security to industrial safety, ABUS is dedicated to making life more secure for a diverse range of users with its quality products and exceptional service.

FIND US @ABUSUSA!



ABUS USA | www.abus.com

23910 North 19th Avenue, #56 | Phoenix, AZ 85085

P: 800-352-ABUS | F: 623-516-9934 | customerservice@us.abus.com

Due to a policy of continental development, ABUS reserves the right to modify technical details & colors. E&OE ABUS © 2021



05/21 ABUS Catalog
Part 97501

