



Security Tech Germany

A close-up, high-angle photograph of a white ABUS motorcycle helmet. The helmet is the central focus, with its top and side panels visible. The ABUS logo is printed on the lower front and side of the helmet. The background is dark and out of focus, showing a blurred sign with the word "FINNISH".

MOBILE SECURITY
CATALOGUE
2024

Advantages of the new 2024 catalogue

- Find products quicker and more easily
- Product features instantly visible



Learn more inside!

PICTOGRAMS



New product



New colour

LOCKS



Double locking

Dual locking of the shackle in the lock body



Pocket size

Lock in small format



XL size

Lock in large format



LED key

Lighted key included



Automatic locking

No active locking with a key required



Robust webbing

High-tech mesh, durable and hydrophobic



Individual code

Combination code can be freely selected



Rechargeable

Rechargeable battery



Universal fitting

Thanks to the variable mounting slots the lock can be attached to all common frame fittings



Battery

Including battery



SmartX

Innovative locking system, controlled via smartphone



XPlus

Picking-resistant disc cylinder „XPlus“



Lightweight

Lightweight lock, ideal for performance riders



Alarm

Lock with 100 dB alarm function



OEM

Locks are delivered without sales packaging so they can be mounted more quickly. Ideal for use in workshops



One Key Option

Multiple locks can be produced keyed alike and thus operated with one key

HELMETS



Bug mesh

Full protection from insects



Ponytail compatibility

Perfect fit for people with long hair



Half-ring

Adjustable ring connected to adjustment system enclosing half of the head



Full-ring

Adjustable ring connected to adjustment system enclosing all of the head



ActiCage

Structural reinforcement integrated into the EPS to optimize stability



XL Size

Large helmet sizes available (62+ cm)



Ventilation

Number of air intakes and outlets



Quin Ready

The helmet can be retrofitted with the QUIN system



Quin

QUIN is an impact detection sensor that independently calls for help in emergency situations



ABUS

DESIGNED & ENGINEERED
IN GERMANY

ABUS

ABUS

CONTENT



ABUS - Made in Germany	004
Approvals	005
ONE KEY	006
Key Service	010
The ABUS Level System	012
U-Shackle locks	014
Folding locks	026
Chain locks	042
Goose Lock	062
Steel-O-Flex locks	066
Coil cable and cable locks	074
Frame locks and battery locks	090
Special security	104
Brackets and Bags	128
ABUS OEM	148
Road	150
MTB	178
Urban	196
Kids	238
Helmet accessories	260
Lumino	268
Shop in Shop	278
Index	287

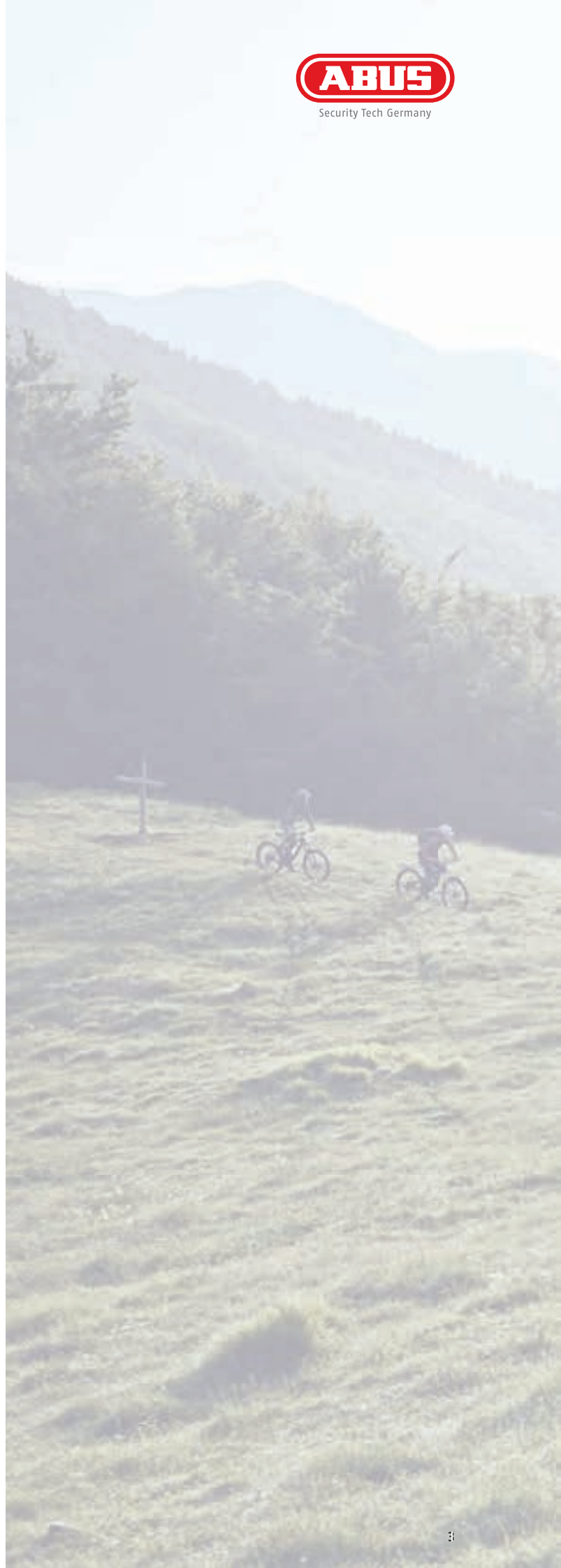

ABUS - MADE IN GERMANY

When August Bremicker and his sons founded ABUS in 1924, they had a lot of experience with engineering and craftsmanship – as well as a very clear vision: They wanted to create products that protected human life and property. It was a far-sighted corporate goal – paired with an expectation for quality right from the start. It was the start of a continuous success story. The ABUS brand became a synonym for security world-wide.



HIGH-QUALITY MATERIALS

To be able to offer consistently high quality and security against every type of brutal and intelligent attack technique, we use the highest-quality materials at every price level. Complex hardening processes guarantee the best resistance in our materials. Our internal quality management check all materials before and during the production process to ensure every product has the high quality you demand.

THE KEY TO SUCCESS

At ABUS, we design and build the tools and machines used in the production of our products in-house. That bundles knowhow, guarantees jobs, and strengthens identification. Our own engineering and toolmaking department concentrates exclusively on the development of bicycle and motorcycle locks. This ensures that we meet the tough requirements you place on your bicycle or motorcycle lock every day.

ENSURING CONSISTENCY

In our own ABUS test laboratory, we routinely carry out tests and attacks on our products to ensure our products offer consistently high quality.

Among others we make sure our locks are resistant to:

- Ice spray attacks and freezing conditions at -40°C
- Twisting, pulling, hammering and sawing attacks with help of our manual or mechanical tests
- Rust by simulating highly corrosive weather conditions



APPROVALS

ABUS locks are tested and approved by independent testing institutions in a number of European countries. As every test lab use different tools, techniques and machines to test both security and quality we are very proud of the high number of different approvals given to ABUS products. If a lock can pass the varying test requirements in many different countries you can be sure it is of the highest possible quality and security.

The following seals of approval confirm the outstanding security of ABUS cycle locks:



Svensk Brand- och
Säkerhetscertifiering AB
Stockholm, Sweden



Norges Forsikringsforbund
Oslo, Norway



Dansk Varefakta Naevn
Copenhagen, Danmark



Finanssiala
Helsinki, Finland



ART (ANWB, RAI, Theft Insurers)
Nieuwegen, The Netherlands



Sold Secure
Rugby, Great Britain



FUB 2-roues
Valence, France



Test Seal VdS
Cologne, Germany



ABUS Seal for Ice Spray Test
Volmarstein, Germany





ONE KEY™ SIMPLE. INDIVIDUAL.

HAVE CUSTOM BIKE LOCKS MADE - OPERATE EVERYTHING WITH JUST ONE KEY!

A primary lock, a frame lock, a padlock, and even a battery lock for e-bikes - if you want to secure your bike properly, you need a lot of locks. That is why we at ABUS, with the ONE KEY system, offer the ability to produce locks for your customers in such a way that they can all be operated with one key. No mess, no looking for keys.

HOW ONE KEY™ WORKS

It's quite simple. Each ABUS lock has an individual key code with which spare keys or matching "keyed alike" locks can be made - even years after purchase. All that matters is that the locks from ABUS have the same type of cylinder installed.

HERE'S HOW IT WORKS



The order is conveniently placed via the Partner-Portal.



1. Read key code from code card



2. Choose suitable products at your retailer



3. 1 week to manufacture your custom product



4. Pick up at retailer or ship to home



FAMILIAR FACE – NEW DESIGN

As a manufacturer of cylinders and bicycle locks, ABUS has the unique opportunity on the market to manufacture custom locks so that they can all be operated with one key – or “keyed alike”. It is important that the locks be compatible with each other for this purpose.

So far we have marked our products and campaigns with these icons:

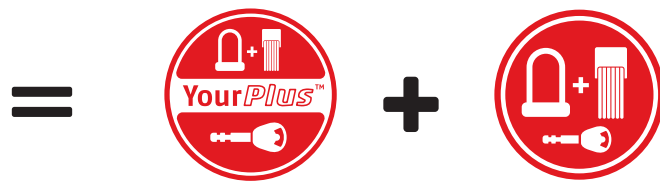

With YourPlus™, we have combined all locks that have a Plus cylinder.

This icon currently indicates that this lock can be keyed alike.

FROM NOW ON, WE'RE BRINGING EVERYTHING TOGETHER UNDER ONE KEY™ – A CLEAR PROMISE FOR MORE CONVENIENCE.

OVERVIEW OF KEYED ALIKE PRODUCTS

PRODUCTS WITH XPLUS CYLINDER

GRANIT™ Super Extreme 2500
 GRANIT™ Extreme 59
 GRANIT XPlus™ 540
 BORDO GRANIT XPlus™ 6500K
 BORDO GRANIT XPlus™ 6500KA
 BORDO™ 6000K
 BORDO™ 6000KA
 Steel-0-Chain™ 9809K
 Steel-0-Chain™ 9808K
 GRANIT City Chain XPlus™ 1060
 6950M XPlus™

PRODUCTS WITH PLUS CYLINDER

GRANIT™ Plus 640
 GRANIT™ Plus 470
 CityChain™ 1010

EC CYLINDER

GRANIT™ 460
 PHANTOM™ 8960

Surcharge
 for manufacturing
 only 10%
 of the price
 of the lock



MAXIMUM CONVENIENCE FOR YOUR CUSTOMERS

- + no chaos, no looking for keys
- + for e-cyclists with battery lock, frame lock, bike lock
- + for families with multiple locks
- + for couples or friends sharing their bike

ONE KEY PRICE LIST

U-SHACKLE LOCKS

98210	2500/165AB230 +USH2500 gl. Granit Super Extreme
95475	540/160HB300+SH B gl. One Key GRANIT XPLUS
95474	540/160HB230+SH B gl. One Key GRANIT XPLUS
4409	540/160HB300+EaZy KF gl. One Key GRANIT XPLUS
4407	540/160HB230+EaZy KF gl. One Key GRANIT XPLUS
4410	540/160HB300+USH540 gl. One Key GRANIT XPLUS
4408	540/160HB230+USH540 gl. One Key GRANIT XPLUS
70665	540/160HB300 gl. One Key GRANIT XPLUS
4411	540/160HB230 gl. One Key GRANIT XPLUS
81461	640/135HB230 BK TexKF gl. One Key GRANIT PLUS
81460	640/135HB150 BK gl. One Key GRANIT PLUS
81459	640/135HB150 BK/RD gl. One Key GRANIT PLUS
95473	470/150HB300+SH B gl. One Key GRANIT PLUS
95472	470/150HB230+SH B gl. One Key GRANIT PLUS
81464	470/150HB300+EaZy KF gl. One Key GRANIT PLUS
81462	470/150HB230+EaZy KF gl. One Key GRANIT PLUS
81465	470/150HB300+USH gl. One Key GRANIT PLUS
81463	470/150HB230+USH gl. One Key GRANIT PLUS
95471	460/150HB300+SH B gl. One Key GRANIT
95470	460/150HB230+SH B gl. One Key GRANIT
4417	460/150HB300+USH gl. One Key GRANIT
4416	460/150HB230+USH gl. One Key GRANIT

FOLDING LOCKS

67593	6500K/120 BK SH gl. One Key BORDO Granit XPlus
91203	6500K/90 BK SH gl. One Key BORDO Granit XPlus
64172	6500KA/90 BK SH gl. One Key BORDO Granit XPlus
67533	6000K/120 BK SH gl. One Key BORDO Big
67509	6000K/90 BK SH gl. One Key BORDO

FOLDING LOCKS

67464	6000K/120 BK ST gl. One Key BORDO Big
67463	6000K/90 BK ST gl. One Key BORDO
67614	6000KA/120 BK SH gl. One Key BORDO Big Alarm
67608	6000KA/90 BK SH gl. One Key BORDO Alarm
81380	6000/120 BK SH gl. One Key BORDO Big
72987	6000/90 BK SH gl. One Key BORDO
83747	6000A/120 BK SH gl. One Key BORDO Big Alarm
80940	6000A/90 BK SH gl. One Key BORDO Alarm
34572	5900/90 BK ST gl. One Key BORDO Classic
78065	6055K/60 BK gl. One Key BORDO LITE MINI
82573	6055K/60 MOVISTAR gl. One Key BORDO LITE MINI
82574	6055K/60 RD gl. One Key BORDO LITE MINI

CHAIN LOCKS

42277	1060/170 gl. One Key City Chain XPlus
42275	1060/140 gl. One Key City Chain XPlus
30595	1060/110 gl. One Key City Chain XPlus
42276	1060/85 gl. One Key City Chain XPlus
21578	1010/170 black gl. One Key City Chain
21577	1010/140 black gl. One Key City Chain
21576	1010/110 black gl. One Key City Chain
71549	1010/85 black gl. One Key City Chain
95555	9809K/140 BK gl. One Key Steel-0-Chain
95556	9809K/170 BK gl. One Key Steel-0-Chain
95554	9809K/110 BK gl. One Key Steel-0-Chain
95553	9809K/85 BK gl. One Key Steel-0-Chain

CHAIN LOCKS

97171	9808K/170 BK gl. One Key Steel-0-Chain
97170	9808K/140 BK gl. One Key Steel-0-Chain
97169	9808K/110 BK gl. One Key Steel-0-Chain
97172	9808K/85 BK gl. One Key Steel-0-Chain

STEEL-O- FLEX LOCKS

77088	8960/110 TexFL gl. One Key PHANTOM
78593	8960/85 KF gl. One Key PHANTOM

FRAME LOCKS

96220	6950M AM NR BK OE gl. One Key XPLUS
95905	6950M AM R BK OE gl. One Key XPLUS
96218	6950ML NR BK OE gl. One Key XPLUS
96219	6950ML R BK OE gl. One Key XPLUS
90764	5955 NR BK gl. One Key PRO SHIELD XPLUS
91147	5955 R BK gl. One Key PRO SHIELD XPLUS
91145	5755L NR BK OE gl. One Key SHIELD XPLUS
91146	5755L R BK OE gl. One Key SHIELD XPLUS
79846	5950 NR BK gl. One Key PRO SHIELD
87766	5950 R BK gl. One Key PRO SHIELD
81477	5750L NR BK gl. One Key SHIELD PLUS
81476	5750L R BK gl. One Key SHIELD PLUS

BATTERY LOCKS

95510	BLO BOS IT3 XPlus OE gl.
95511	BLO BOS IT2.1 XPlus OE gl.
83447	BLO BOS IT2.1 PLUS gl.
90730	BLO BOS DT3 XPlus OE gl.
68734	BLO BOS DT2 XPlus OE gl.
81479	BLO BOS DT2 PLUS gl.
90913	BLO BOS RT2 XPlus OE gl.

BATTERY LOCKS















73289	BLO BOS RT2 PLUS gl.
91226	BLO CUB IT2.B3 XPlus OE gl.
91225	BLO CUB IT2 XPlus OE gl.
96627	BLO CUB IT2 Plus OE gl.
91224	BLO CUB IT1.B3 XPlus OE gl.
91223	BLO CUB IT1 XPlus OE gl.
95514	BLO CUB IT1 PLUS OE gl.
95529	BLO KTM IT1 XPlus OE gl.
95512	BLO SHI IT2 XPLUS OE gl.
95519	BLO SHI IT2 PLUS OE gl.
83451	BLO SHI DT1 PLUS OE gl.
95521	BLO WIN IT4 PLUS OE gl.
87544	BLO WIN IT3 PLUS OE gl.
87543	BLO WIN IT2 PLUS OE gl.
87542	BLO WIN IT1 PLUS OE gl.
95520	BLO ZEG IT5 PLUS OE gl.
95513	BLO ZEG IT4 XPlus OE gl.
95517	BLO ZEG IT4 PLUS OE gl.
95516	BLO ZEG IT3 PLUS OE gl.















KEY SERVICE

The ABUS key service allows you to order new keys for existing locks.

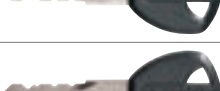
Just select the required blank, enter the desired coding and the key will be delivered within no time.

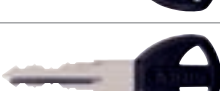

	Cylinder type	EAN-No.:	Item no
	XPlus (illuminated key)	4003318357565	35756 5
	XPlus	4003318246579	24657 9
	Plus (illuminated key)	4003318357572	35757 2
	Plus	4003318062278	06227 8
	8N	4003318816635	81663 5
	6N	4003318709777	70977 7
	T82	4003318561139	56113 9
	T83	4003318844867	84486 7
	F82	4003318815263	81526 3
	P82	4003318827044	82704 4
	E6	4003318822452	82245 2
	KC 54	4003318815270	81527 0
	ML54	4003318815287	81528 7
	NW52 black	4003318546938	54693 8

	Cylinder type	EAN-No.:	Item no
	NW72 red	4003318547539	54753 9
	PL1	4003318818684	81868 4
	RH 5	4003318835957	83595 7
	RH EC	4003318267666	26766 6
	U72	4003318815294	81529 4
	U73	4003318815300	81530 0
	U74	4003318815317	81531 7
	V61	4003318815324	81532 4
	V62	4003318815348	81534 8
	V63	4003318815331	81533 1
	V64	4003318815355	81535 5
	V65	4003318815362	81536 2
	Z72	4003318815379	81537 9
	Z73	4003318815386	81538 6
	Z74	4003318815393	81539 3
	ABUS - Voucher for Plus or XPlus	4003318043185	04318 5
	ABUS - Voucher for ABUS other	4003318290015	29001 5

THE ABUS LEVEL SYSTEM

Finding the right lock for your customer requires a few questions that can help in the selection process. A lock must not only be secure, it must also suit the user.

The questions below can help you figure out what your customer is looking for:

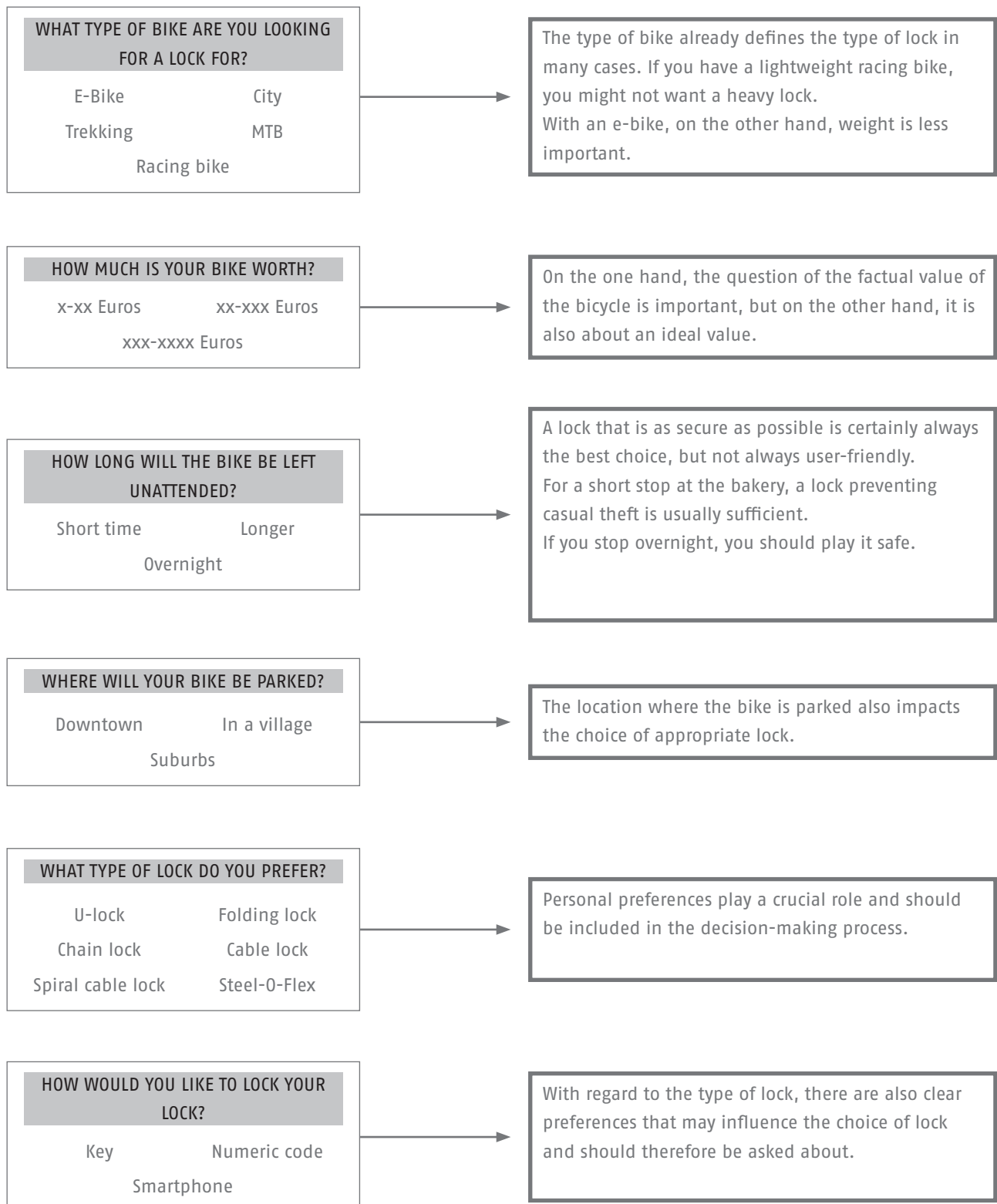

In the sales conversation, you get the best feel for your customer and a sense for what they value.

Many questions are rather soft factors and have an influence on the choice of the lock, but not so much on the choice of the appropriate security level.

The most important factors in determining the level of protection required are the bicycle value, location and length of time the bike is left.

For this, we recommend the following reference:

	Rural region 	Suburban 	Urban 
Quickstop	2 - 4	7 - 10	13 - 15
Few hours	5 - 6	10 - 13	13 - 15
All day	6 - 7	13 - 15	15
Overnight	7 - 10	15	15

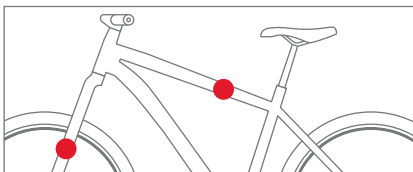

Lock your bike in illuminated and well frequented areas.

Secure you bike to an immovable object and lock both, frame and front wheel.

Keep the lock as high as possible and pass it through the frame as much as you can. This makes it harder to attack.

U-SHACKLE LOCKS



GRANIT™ EXTREME 59



black

Page 16

GRANIT™ SUPER EXTREME 2500



black

Page 17

GRANIT XPLUS™ 540



black

Page 18

GRANIT™ PLUS 640



red

Page 19



black

Page 19

GRANIT™ PLUS 470



black

Page 20

ULTIMATE 420



red

Page 21

GRANIT™ 460



black

Page 22

440 ALARM



red

Page 23

ULTRA 410



green

Page 24

FACILO 32



black

Page 25

402



yellow

Page 25

GRANIT™ EXTREME 59

SECURITY LEVEL



Security Level
Motorbike

FEATURES



XPlus™



SH 59



TECHNICAL DATA



- 16 mm square parabolic shackle
- Double-locking mechanism securing the shackle in the lock body
- The shackle, the lock body and the structural parts of the locking mechanism are manufactured using specially hardened steel
- ABUS XPlus cylinder for exceptionally high protection against manipulation attempts such as picking
- Two keys are included in the scope of delivery
- Manual cover to protect the keyhole from dirt and corrosion
- ABUS Code Card for additional and replacement keys

TECHNOLOGY



TEST SEALS



Ref. No.	EAN 4003318	 mm	 mm	 mm	Weight g	Box Qty
59/180HB245	58606 4	111	245	19	2600	1
59/180HB260	58607 1	111	260	19	2700	1
SH59	23763 8				420	2

GRANIT™ SUPER EXTREME 2500

NEW

U-Shackle locks

SECURITY LEVEL



FEATURES



USH2500



TECHNICAL DATA

- Hardened 20 mm square parabolic shackle with 7 mm plastic coating
- The lock shackle and body are better protected against brutal saw attacks with angle grinders thanks to a special tungsten carbide compound
- Double locking of the shackle in the lock body
- The shackle, housing and structural parts of the locking mechanism are made of specially hardened steel
- ABUS XPlus™ cylinder for extremely high protection against manipulation, e.g. picking
- ABUS Power Cell technology offers maximum protection against impacts and attempts to break open the lock
- Two keys included in the scope of delivery
- ABUS Code Card for spare and replacement keys
- Suitable holder USH 2500 for transport on the rack, rear of the bike, etc.
- Simplified mounting of USH 2500 as holder can be swivelled axially for attachment
- Flexible and firm holder fixation with coated metal fixing straps

TECHNOLOGY



TEST SEALS



Ref. No.	EAN 4003318	mm	mm	mm	Weight g	Box Qty
2500/165HB230	99680 1	102	230	27	2200	1
2500/165HB230 + USH2500	96050 5	102	230	27	2520	1

GRANIT™ XPLUS™ 540

SECURITY LEVEL



FEATURES

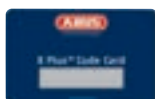

XPlus™



USH 540



SH B



TECHNICAL DATA

- 13 mm hardened square shaft parabolic shackle
- ABUS power cell technology offers the highest level of protection against impacts and attempts to break open the lock
- The shackle, housing and the structural parts of the locking mechanism are made of specially hardened steel
- ABUS XPlus cylinder for the highest level of protection against tampering, e.g. picking
- Automatic keyhole cover to protect against dirt and corrosion

TECHNOLOGY



TEST SEALS



1) 30330

Ref. No.	EAN 4003318	mm	mm	mm	Weight g	Box Qty
540/160HB230	11161 7	108	230	17	1500	6
540/160HB300	11179 2	108	300	17	1700	6
540/160HB230 + USH540	11186 0	108	230	17	1650	4
540/160HB300 + USH540	11188 4	108	300	17	1850	4
540/160HB230 + SH B	69076 1	108	230	17	1650	3
540/160HB300 + SH B	69075 4	108	300	17	1850	3

GRANIT™ PLUS 640

SECURITY LEVEL



FEATURES



Plus



Support TexKF Mini



VERSIONS



HB150 black



HB230 black

TECHNICAL DATA

- Hardened 12 mm round shackle
- The shackle, the lock body and the structural parts of the locking mechanism are manufactured using specially hardened steel
- Priority given to the use of weight-optimised special alloys and lightweight materials
- ABUS Plus cylinder including automatic cover for maximum protection against attempts at manipulation, e.g. picking

TECHNOLOGY



TEST SEALS



1) Only for SE-version (Art.-No. 72509), 2) 31644

Ref. No.	EAN 4003318	mm	mm	mm	Weight g	Box Qty
640/135HB150 red	39704 2	83	150	15	800	4
640/135HB150 black	39702 8	83	150	15	800	4
640/135HB230 + TexKF black	39703 5	83	230	15	1030	6

GRANIT™ PLUS 470

SECURITY LEVEL



FEATURES



Plus



USH 460/470/32



SH B

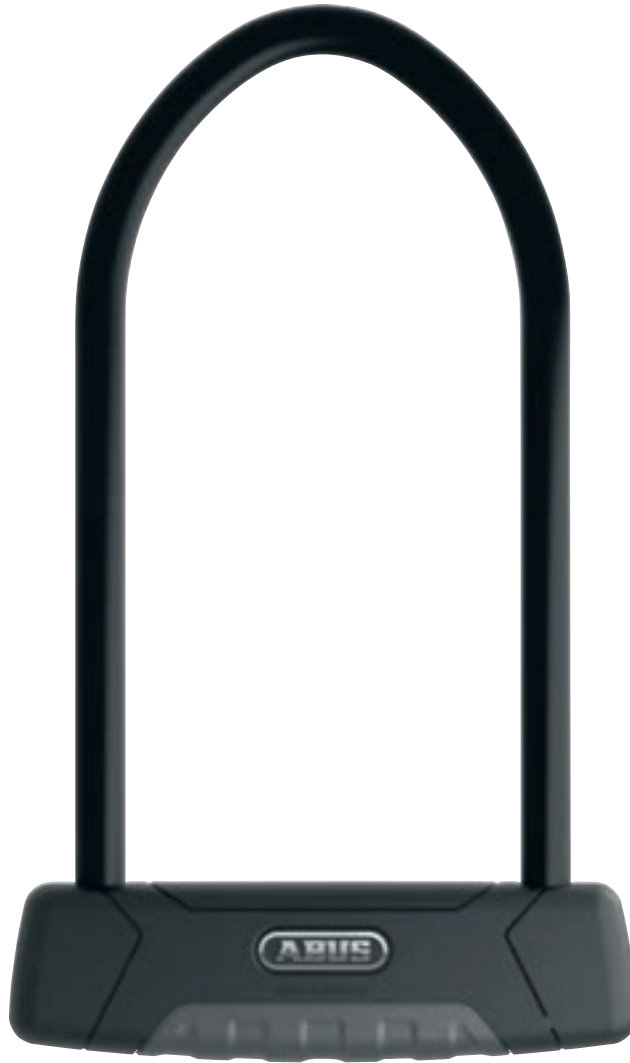

TECHNICAL DATA

- Hardened 12 mm parabolic shackle
- ABUS Power Cell technology provides outstanding protection against attempts to remove the lock by hitting or pulling
- The shackle, the body and the load-bearing parts of the locking mechanism are manufactured from specially hardened steel
- Automatic cover to protect the keyhole from contamination and corrosion

TECHNOLOGY



TEST SEALS



1) 30328

Ref. No.	EAN 4003318	mm	mm	mm	Weight g	Box Qty
470/150HB230 + USH470	11249 2	109	230	14	1260	4
470/150HB300 + USH470	11251 5	109	300	14	1320	5
470/150HB230 + SH B	69073 0	109	230	14	1290	3
470/150HB300 + SH B	69072 3	109	300	14	1350	1

ULTIMATE 420

SECURITY LEVEL



FEATURES



USH



TECHNICAL DATA

- Hardened 13 mm round bracket
- The shackle, housing and supporting parts of the locking mechanism are made of specially hardened steel
- Special, modern design of the lock body sheathing enables optimum handling
- High-quality locking cylinder for high protection against manipulation, e.g. picking



TECHNOLOGY



TEST SEALS



1) 33241

Ref. No.	EAN 4003318	 mm	 mm	 mm	Weight g	Box Qty
420/150HB140 + USH Ultimate	81689 5	80	140	17	900	6
420/170HB230 + USH Ultimate	39631 1	100	230	17	1100	6
420/150HB140 + USH + 10/120 Ultimate	81969 8	80	140	17	1240	6
420/170HB230 + USH + 10/120 Ultimate	39633 5	100	230	17	1440	6

GRANIT™ 460

SECURITY LEVEL



FEATURES



USH 460/470/32



SH B



TECHNICAL DATA

- Hardened 12 mm parabolic shackle
- The shackle, the lock body and the structural parts of the locking mechanism are manufactured using specially hardened steel
- ABUS Extra Class cylinder with coded reversible key

TECHNOLOGY



TEST SEALS



Ref. No.	EAN 4003318				Weight g	Box Qty
		mm	mm	mm		
460/150HB230 + USH460	11253 9	109	230	14	1000	4
460/150HB300 + USH460	11255 3	109	300	14	1250	5
460/150HB230 + SH B	69070 9	109	230	14	1050	3
460/150HB300 + SH B	69071 6	109	300	14	1300	3

440 ALARM

SECURITY LEVEL



FEATURES



USH



TECHNICAL DATA

- Hardened 12 mm round shackle
- The shackle, the body and the load-bearing parts of the locking mechanism are manufactured using specially hardened steel
- Special, modern design of the lock body casing allows for optimum handling
- High-quality locking cylinder for high protection against manipulation, e.g. picking
- Alarm at a volume of at least 100 dB for 15 seconds, followed by automatic reactivation
- 3D Position Detection – detects vibrations and the smallest of movements and triggers an alarm
- CR2 batteries included

TECHNOLOGY



TEST SEALS



Ref. No.	EAN 4003318	mm	mm	mm	Weight g	Box Qty
440A/150HB160 USH Alarm	82605 4	85	160	14	1100	6
440A/170HB230 USH Alarm	82606 1	108	230	14	1500	6

ULTRA 410

SECURITY LEVEL



FEATURES



Support USH 34

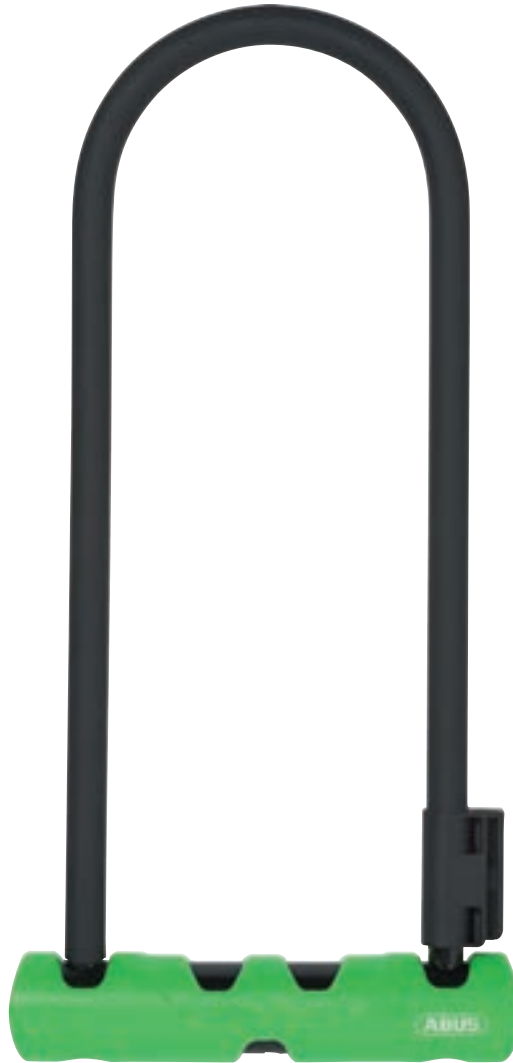

VERSIONS



410/150HB140



410/150HB140 + 10/120



410/150HB180 + 10/120

TECHNICAL DATA



- Hardened 12 mm round shackle
- The shackle, body and the structural parts of the locking mechanism are made of specially hardened steel
- The special, modern design of the lock body casing allows for optimum handling
- High-quality locking cylinder for a high level of protection against tampering, e.g. picking

TECHNOLOGY



TEST SEALS



Ref. No.	EAN 4003318	 mm	 mm	 mm	Weight g	Box Qty
410/150HB140 green SH34	34594 4	80	140	14	755	6
410/150HB140 green SH34 + Cobra 10/120	34596 8	80	140	14	755 + 340	6
410/150HB180 green SH34 + Cobra 10/120	34597 5	80	180	14	835 + 340	6
410/170HB230 green SH34 Ultra	34591 3	110	230	14	1000	6
410/170HB230 green SH34 Ultra + Cobra 10/120	34590 6	110	230	14	1000 + 340	6

FACILO 32

FEATURES



USH 460/470/32

SECURITY LEVEL



TECHNICAL DATA



- Hardened 12 mm round shackle
- ABUS top-quality locking cylinder
- PVC casing to prevent damage to paintwork

TECHNOLOGY



TEST SEALS



Ref. No.	EAN 4003318	 mm	 mm	 mm	Weight g	Box Qty
32/150HB230 + USH32	37492 0	109	230	15	950	6
32/150HB300 + USH32	37887 4	109	300	15	1160	6

402

FEATURES



Support USH 34

SECURITY LEVEL



TECHNICAL DATA

- 11 mm, hardened steel round shackle
- Double-locking mechanism securing the shackle in the lock body
- The shackle, the body and the load-bearing parts of the locking mechanism are manufactured using specially hardened steel
- Special, modern design of the lock body casing allows for optimum handling

TEST SEALS



TECHNOLOGY



Ref. No.	EAN 4003318	 mm	 mm	 mm	Weight g	Box Qty
402/170HB230 yellow SH34	86742 2	110	230	11	890	6

FOLDING LOCKS



**BORDO™
6500A SMARTX**



6500A/110
black
Page 30

**BORDO GRANIT™
6500KA**



6500KA/90
black
Page 31

**BORDO GRANIT™
6500K**



6500K/90
black
Page 32



6500K/120
black
Page 32

**BORDO™
6000A SMARTX**



6000A
black
Page 33



**BORDO™
6000KA**



6000KA/90
black
Page 34



6000KA/120
black
Page 34

**BORDO™
6000K**



6000K/90
black
Page 35



6000K/120
black
Page 35

**BORDO™
6000C**



6000C/90
black
Page 36

**BORDO™
6000C LED**



6000C/90 LED
black
Page 37

**UGRIP BORDO™
5700K**



black
Page 38



lime
Page 38



blue
Page 38



red
Page 38

**UGRIP BORDO™
5700C**



red
Page 39



black
Page 39

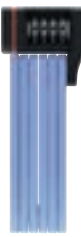

blue
Page 39

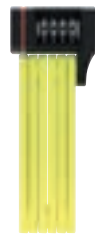

lime
Page 39

**BORDO™
LITE 6055K**



Movistar Team

Page 40



black

Page 40



red

Page 40

**BORDO™
LITE 6055C**



black

Page 41



red

Page 41

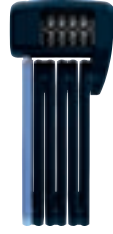

Movistar Team

Page 41



pink SYMBOLS

Page 41



blue SYMBOLS

Page 41



BORDO™ 6500A SMARTX

SECURITY LEVEL



FEATURES



Bracket SH BORDO 6500A
SmartX



SmartX RC



Controlled by iOS- and Android Smartphones or using the Smart Remote (available separately)

TECHNICAL DATA

- 5.5 mm thick bars, with extra-soft 2-component coating
- Easy operation via the ABUS One app (previously SmartX) – for iOS and Android
- Bike lock can be opened and locked without a key – keyless function based on proven ABUS SmartX™ Bluetooth® technology
- Alarm function with min. 100 dB for 15 seconds, then automatic re-arming
- 3D position detection – detects vibrations and the smallest of movements in all three dimensions and triggers an alarm
- Smart alarm – the lock only emits a short warning tone in the event of minor and brief vibrations, e.g. if a football bounces nearby
- USB-C port
- Storage of the bike's last parking location
- LED light indicates battery and charging status
- RC variant can be operated via included remote control (for all other variants, the remote control is available separately)
- Incl. holder (SH)

TECHNOLOGY



TEST SEALS



Ref. No.	EAN 4003318	 cm	Weight g	Box Qty
6500A/110 black SH SmartX™	61495 8	110	2300	3
6500A/110 black SH RC SmartX™	61497 2	110	2320	3
SH 6500A SmartX™	63488 8		148	1
SmartX™ RC	64000 1		70	1

BORDO GRANIT™ 6500KA

SECURITY LEVEL



FEATURES



XPlus™

Bracket SH 6500K/90



Folding locks

TECHNICAL DATA

- 5.5 mm thick bars, extra-soft coating to prevent damage to paintwork
- The bars and body are made of specially hardened steel
- Alarm function with at least 100 dB for 15 seconds followed by automatic re-arming
- 3-D positional alarm detection - detects shocks and movements in all dimensions
- Smart alarm - the lock only emits a small warning tone in the event of small and short shocks, e.g. if a football hits the bike
- ABUS Link Protection Shield for high protection against attacks on the joints
- Incl. holder (SH)
- ABUS XPlus cylinder for the greatest protection against manipulation, e.g. picking
- Acoustic signal indicates battery status and active status
- Transport position - do not insert the locking bar completely, so that the alarm is inactive
- Alarm position - insert locking bar completely; the alarm will be activated after locking
- Speaker shielded behind the locking bar
- Incl. SH lock carrier for transport on the bike

TECHNOLOGY



TEST SEALS



Ref. No.	EAN 4003318	 cm	Weight g	Box Qty
6500KA/90 black SH	69052 5	90	2020	3
SH 6500K/90	69051 8		195	3

BORDO GRANIT™ 6500K

SECURITY LEVEL



FEATURES



Bracket SH 6500K/90



VERSIONS



6500K/90 Twinset



6500K/120

TECHNICAL DATA

- 5.5 mm thick bars, extra-soft coating to prevent damage to paintwork
- The bars, housing and the structural parts of the locking mechanism are manufactured from specially hardened steel
- ABUS Link-Protection-Shield offers high protection at the links
- ABUS XPlus cylinder for the greatest protection against manipulation, e.g. picking
- This lock can be made keyed alike to a variety of other locks
- Incl. SH lock carrier for transport on the bike

TECHNOLOGY



TEST SEALS



1) 37547

Ref. No.	EAN 4003318	 cm	Weight g	Box Qty
6500K/90 black SH	61498 9	90	1670	4
6500K/90 black SH TwinSet	61499 6	90	1670 per lock	2
6500K/120 black SH	62115 4	120	2470	3
SH 6500K/90	69051 8		195	3
SH 6500K/120	96279 0		230	1

BORDO™ ONE 6000A

NEW

Folding locks

SECURITY LEVEL



FEATURES



Bracket SH 6000/120



SmartX RC



TECHNICAL DATA

- 5 mm thick bars with extra-soft 2-component coating
- Smart locking system with Bluetooth® connection – user-friendly opening and closing without a key via smartphone
- Secure SmartX technology with integration in ABUS One
- Simple and secure integration of multiple users/smartphones
- Alarm function with min. 100 dB for 15 seconds, then automatic re-arming
- 3D position detection – detects vibrations and the smallest of movements in all three dimensions and triggers an alarm
- Smart alarm – the lock only emits a short warning tone in the event of minor and brief vibrations, e.g. if a football bounces nearby
- USB-C port
- Storage of the bike's last parking location
- LED status display
- RC variant can be operated via included remote control (for all other variants, the remote control is available separately)
- Incl. holder (SH)
- CR123A battery

TECHNOLOGY



Ref. No.	EAN 4003318	cm	Weight g	Box Qty
6000A/120 BK SH SmartX™	97338 3	120	1760	1
6000A/120 BK SH RC SmartX™	97339 0	120	1760	1
SH 6000/120	61564 1		132	3
SmartX™ RC	64000 1		70	1

BORDO™ 6000KA

SECURITY LEVEL



FEATURES



XPlus™



Bracket SH 6000/90



Bracket SH 6000/120



VERSIONS



6000KA/120 BK SH

TECHNICAL DATA

- 5 mm bars with extra-soft yet resistant coating to prevent damage to paintwork
- The bars and body are made of specially hardened steel
- Alarm at a volume of at least 100 dB for 20 seconds, followed by automatic re-arming
- 3D position detection - detects vibrations and the smallest of movements in all three dimensions and triggers an alarm
- Smart alarm – the lock only emits a small warning beep in the event of minor and brief vibrations, e.g. if a football bounces nearby
- Acoustic signal indicates battery status and active status
- Bars are connected by special rivets
- ABUS XPlus cylinder for the greatest protection against manipulation, e.g. picking
- SH carrier included
- Transport position - do not insert the locking bar completely, so that the alarm is inactive
- Alarm position - insert locking bar completely; the alarm will be activated after locking
- Loudspeaker shielded behind locking bar

TECHNOLOGY



TEST SEALS



Ref. No.	EAN 4003318	cm	Weight g	Box Qty
6000KA/90 black SH	61500 9	90	1450	4
6000KA/120 black SH	62090 4	120	1700	4
SH 6000/90	61543 6		115	3
SH 6000/120	61564 1		132	3

BORDO™ 6000K

SECURITY LEVEL



FEATURES



XPlus™



Bracket SH 6000/90



Bracket SH SF 6000/90



Bracket SH 6000/120



VERSIONS



6000K/120

Folding locks

TECHNICAL DATA

- 5 mm bars with extra-soft yet resistant coating to prevent damage to paintwork
- The bars and the housing are made of specially hardened steel
- Bars are connected by special rivets
- ABUS XPlus cylinder for extremely high protection against manipulation, e.g. picking

TECHNOLOGY



TEST SEALS



Ref. No.	EAN 4003318	 cm	Weight g	Box Qty
6000K/90 black SH	62094 2	90	1330	4
6000K/90 black SH TwinSet	62095 9	90	1330 per lock	2
6000K/90 black SH SF	67865 3	90	1330	4
6000K/90 black SHFL	90973 3	90	1330	4
6000K/120 black SH	62091 1	120	1546	4
6000K/120 black SH TwinSet	67465 5	120	1546 per lock	2
Bracket SH 6000/90	61543 6		115	3
Bracket SH SF	67866 0		121	3
Bracket SH 6000/120	61564 1		132	3
Bracket SHFL 6000/90	88886 1		160	3

BORDO™ 6000C

SECURITY LEVEL



FEATURES



Bracket SH 6000/90



Bracket SH SF 6000/90



Bracket SHFL 6000/90

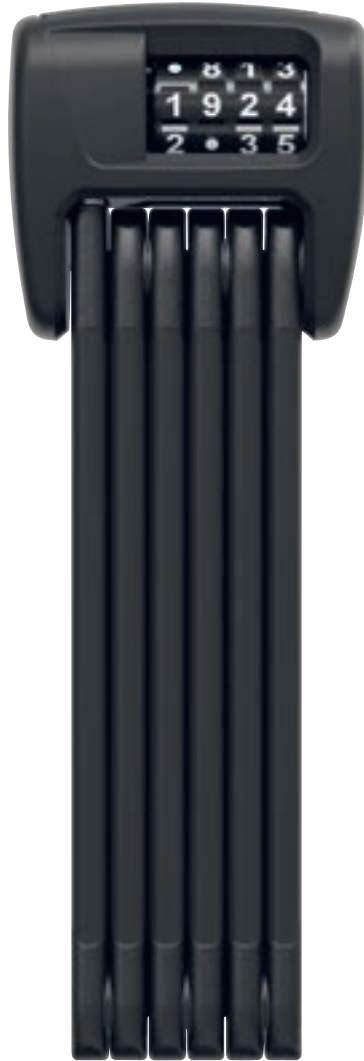

TECHNICAL DATA

- 5 mm bars with extra-soft yet resistant coating to prevent damage to paintwork
- The bars and the housing are made of specially hardened steel
- Bars are connected by special rivets
- Two-component code dials ensures long-lasting legibility
- Opening code can be set individually
- Incl. SH holder

TECHNOLOGY



TEST SEALS



Ref. No.

EAN
4003318



cm

Weight
g

Box
Qty

Ref. No.	EAN 4003318	cm	Weight g	Box Qty
6000C/90 black SH	67599 7	90	1050	4
6000C/90 black SH SF	69069 3	90	1170	4
6000C/90 black SHFL	90972 6	90	1050	1
Bracket SH 6000/90	61543 6		115	3
Bracket SHFL 6000/90	88886 1		160	3
Bracket SH SF	67866 0		121	3

BORDO™ 6000C LED

SECURITY LEVEL



FEATURES



LED



Bracket SH 6000/90



Bracket SHFL 6000/90

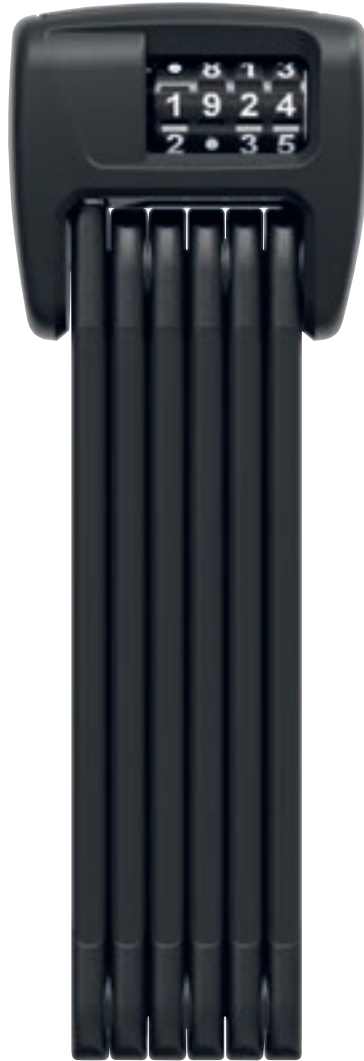

Folding locks

TECHNICAL DATA

- 5 mm thick bars, extra-soft coating to prevent damage to paintwork
- The bars and the housing are made of specially hardened steel
- Bars are connected by special rivets
- Integrated LED lamp for illuminating the code dials
- A CR1220 button battery to power the LED lamp is included
- Two-component code dials ensures long-lasting legibility
- Opening code can be set individually

TECHNOLOGY



TEST SEALS



Ref. No.

Ref. No.	EAN 4003318	 cm	Weight g	Box Qty
6000C/90 LED black SH	69057 0	90	1050	4
Bracket SH 6000/90	61543 6		115	3
Bracket SH SF	67866 0		121	3

UGRIP BORDO™ 5700K

SECURITY LEVEL



FEATURES



Bracket SH 5700/80



Bracket SH 5700K/100



VERSIONS



5700K/100 lime



5700K/80 lime



5700K/100 blue



5700K/80 blue



5700K/100 red



5700K/80 red



5700K/100 black

TECHNICAL DATA

- 5 mm steel bars
- Colour-matching lock body (only "core" colours)
- Bars are linked with special rivets
- High-quality automatic cylinder
- The "convenient transport mode" (CTM) provides an immediate use of the lock (only 5700/100)

TECHNOLOGY



TEST SEALS



Ref. No.	EAN 4003318	cm	Weight g	Box Qty
5700K/80 black SH	84425 6	80	960	6
5700K/80 lime SH	84427 0	80	960	6
5700K/80 blue SH	84426 3	80	960	6
5700K/80 red SH	84428 7	80	960	6
5700K/100 black SH	86743 9	100	1090	6
5700K/100 lime SH	86745 3	100	1090	6
5700K/100 blue SH	86744 6	100	1090	6
5700K/100 red SH	86746 0	100	1090	6
Bracket SH 5700/80	61566 5		122	3
Bracket SH 5700K/100	61571 9		122	3

UGRIP BORDO™ 5700 COMBO

SECURITY LEVEL



FEATURES



SH 5700/80

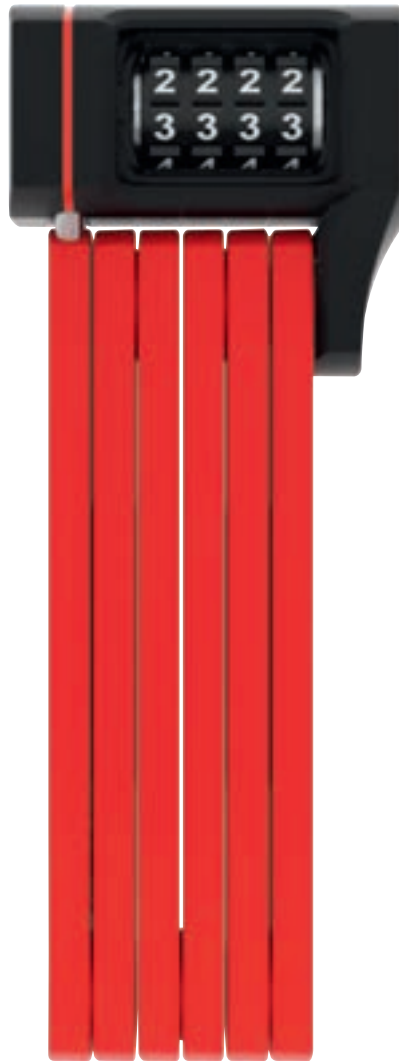

VERSIONS



5700C/80 black

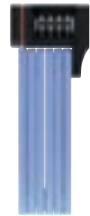

5700C/80 blue



5700C/80 lime

Folding locks

TECHNICAL DATA

- 5 mm steel bars
- Bars are linked with special rivets
- Two component moulded digits guarantee life-long visibility
- Individually settable code

TECHNOLOGY



TEST SEALS



Ref. No.	EAN 4003318	 cm	Weight g	Box Qty
5700C/80 black SH	87791 9	80	960	6
5700C/80 blue SH	87792 6	80	960	6
5700C/80 lime SH	87793 3	80	960	6
5700C/80 red SH	87794 0	80	960	6
Bracket SH 5700/80	61566 5		122	3

BORDO™ LITE 6055K

SECURITY LEVEL



FEATURES



Bracket SH 6055



Bracket SR 6055



VERSIONS



black



black



red



red

TECHNICAL DATA

- Special steel design, with colour-coordinated plastic casing to prevent damage to paintwork
- The bars and housing are manufactured using particularly lightweight materials and steel alloys
- Bars connected with special rivets
- High-quality automatic cylinder
- The BORDO™ Lite Mini is small enough to slip into the pocket of any cycling jersey

TECHNOLOGY



TEST SEALS



Ref. No.	4003318	 cm	Weight g	Box Qty
6055K/60 black	78060 8	60	400	6
6055K/60 black SH	62102 4	60	500	6
6055K/60 black SR	62103 1	60	500	4
6055K/60 red	78061 5	60	400	6
6055K/60 MOVISTAR TEAM	78062 2	60	400	6
6055K/85 black SH	78063 9	85	550	6
6055K/85 black SR	62104 8	85	550	4
6055K/85 red SH	78064 6	85	550	6
Bracket SH 6055	61572 6		60	3
Bracket SR 6055 Selle Royal	63151 1		64	3

BORDO™ LITE 6055 COMBO

SECURITY LEVEL



FEATURES



Bracket SR 6055



Bracket SH 6055



VERSIONS



black



blue Symbols



red



red



Movistar



pink Symbols

Folding locks

TECHNICAL DATA

- Special steel design, with colour-coordinated plastic casing to prevent damage to paintwork
- The bars and housing are manufactured using particularly lightweight materials and steel alloys
- Bars connected with special rivets
- Two-component number reels guarantee long-term readability of the digits
- Individually configurable code
- Perfect security-weight ratio
- Incl. bracket (SH or SR)

TECHNOLOGY



TEST SEALS



Ref. No.	4003318	 cm	Weight g	Box Qty
6055C/60 black	62105 5	60	460	6
6055C/60 black SH	62110 9	60	550	6
6055C/60 black SR	62114 7	60	550	4
6055C/60 red	62106 2	60	460	6
6055C/60 MOVISTAR TEAM	62107 9	60	460	6
6055C/60 pink SYMBOLS	62108 6	60	460	6
6055C/60 blue SYMBOLS	62109 3	60	460	6
6055C/85 black SH	62111 6	85	708	6
6055C/85 black SR	62113 0	85	708	4
6055C/85 red SH	62112 3	85	708	6
Bracket SH 6055	61572 6		60	3
Bracket SR 6055 Selle Royal	63151 1		64	3

CHAIN LOCKS



**GRANIT CITYCHAIN
XPLUS™ 1060**



black

Page 46

**IVY CHAIN
9210**



black

Page 47

**CITYCHAIN™
1010**



black

Page 47

**STEEL-O-CHAIN™
9809K**



black

Page 48

**STEEL-O-CHAIN™
9808K**



black

Page 48

8808C



black

Page 49



russet red

Page 49



jade green

Page 49

**IVEN CHAIN
8210**



black

Page 50

**IVERA CHAIN
7210 COLOR**



racing yellow

Page 51



diving blue

Page 51



crossing grey

Page 51



sparkling orange

Page 51

**IVERA CHAIN
7210**



black

Page 51

**STEEL-O-CHAIN™
8807K**



black

Page 52

**TRESOR
1385**



black

Page 53



aqua

Page 53



coral

Page 53



brown

Page 53

**TRESOR
1385 COLOR**



grey star

Page 54



blue mask

Page 54



grey lightning

Page 54



cherry heart

Page 54

**TRESOR
1385 NEON**



Neon blue

Page 55



black

Page 55



Neon green

Page 55



Neon orange

Page 55



Neon pink

Page 55

**CATENA
6806K**



black

Page 56



aqua

Page 56



coral

Page 56



brown

Page 56

**CATENA
6806K NEON**



Neon pink

Page 56



Neon green

Page 56



Neon blue

Page 56



Neon orange

Page 56

**CATENA
6806K COLOR**



cherry heart

Page 57



blue mask

Page 57



grey lightning

Page 57



grey star

Page 57

**CATENA
6806K REFLECTIVE**



reflective

Page 57

**STEEL-O-CHAIN™
5805K**



black

Page 58



blue

Page 58



red

Page 58



lime

Page 58



pink

Page 58

**STEEL-O-CHAIN™
5805C**

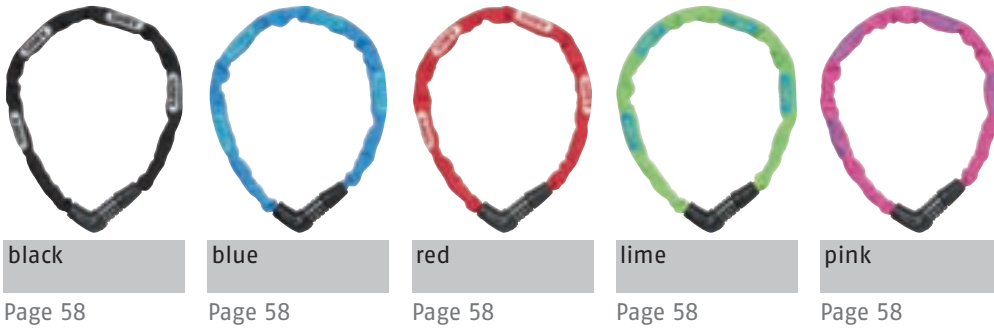

black	blue	red	lime	pink
Page 58	Page 58	Page 58	Page 58	Page 58

**STEEL-O-CHAIN™
4804K**

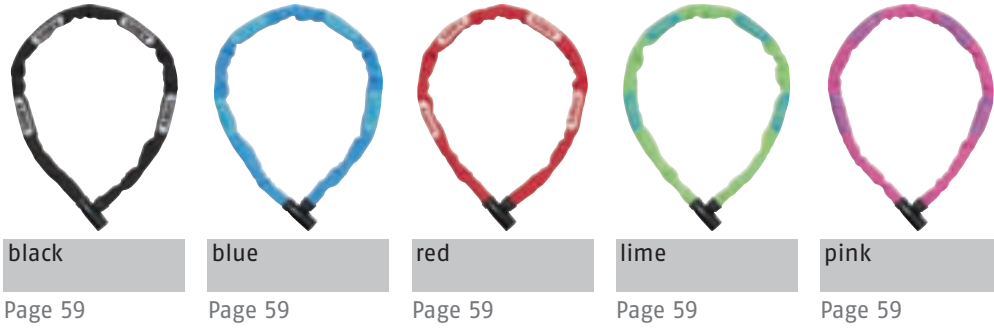

black	blue	red	lime	pink
Page 59	Page 59	Page 59	Page 59	Page 59

**STEEL-O-CHAIN™
4804C SYMBOLS**



lime SYMBOLS	blue SYMBOLS	pink SYMBOLS	red SYMBOLS
Page 60	Page 60	Page 60	Page 60

**STEEL-O-CHAIN™
4804C**

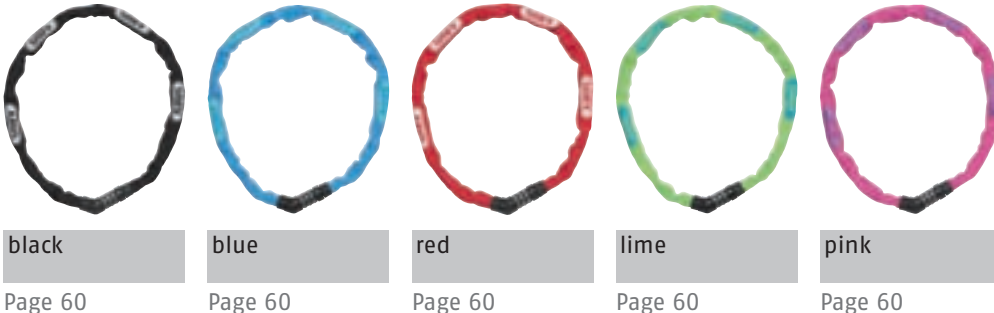

black	blue	red	lime	pink
Page 60	Page 60	Page 60	Page 60	Page 60

1500 WEB

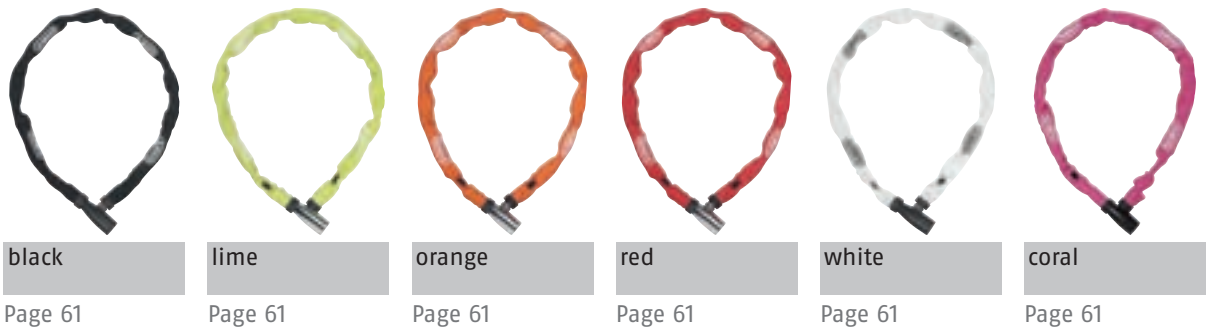

black	lime	orange	red	white	coral
Page 61	Page 61	Page 61	Page 61	Page 61	Page 61

1200 WEB

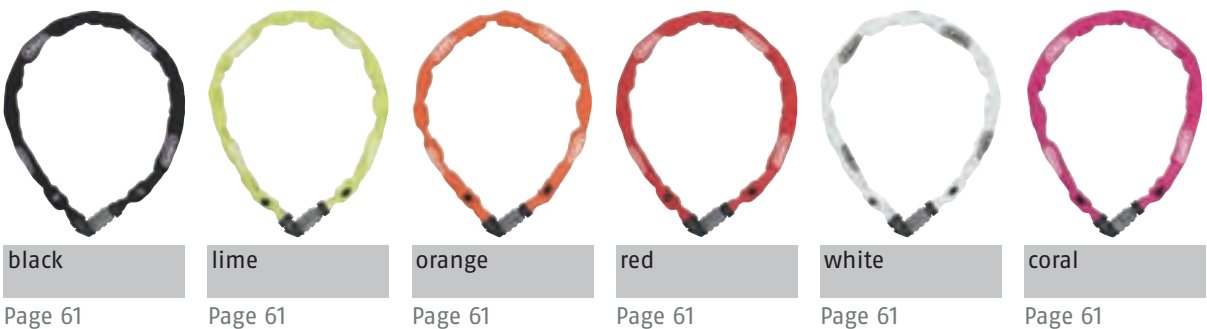

black	lime	orange	red	white	coral
Page 61	Page 61	Page 61	Page 61	Page 61	Page 61

GRANIT CITYCHAIN 1060 XPLUS™

SECURITY LEVEL



FEATURES



TECHNICAL DATA

- 10 mm hexagonal chain with textile sleeve to protect against damage to the paintwork
- ABUS Power Cell technology offers the highest level of protection against impacts and attempts to break the lock
- ABUS Power Link technology enables the chain to be connected directly to the Power Cell
- Interwoven connection of the lock body to protect against brutal methods of attack
- The chain, the lock body and supporting elements of the locking mechanism are made of specially hardened steel
- ABUS XPlus cylinder for the highest level of protection against tampering, e.g. picking
- Cover to protect the keyhole from contamination

TECHNOLOGY



TEST SEALS



1) Class C 2) 17218 3) Only for 1060/85 & 1060/110

Ref. No.	EAN 4003318	⌀ mm	⓪ cm	Weight g	Box Qty
1060/85 black	28678 0	10	85	2100	2
1060/110 black	28623 0	10	110	2650	2
1060/140 black	28624 7	10	140	3260	2
1060/170 black	28625 4	10	170	3750	2

IVY CHAIN 9210

FEATURES



SECURITY LEVEL



TEST SEALS



TECHNICAL DATA

- 10 mm square chain with new functional, durable and highly flexible synthetic fibre sleeve prevents damage to paintwork
- The sleeve offers very high protection against abrasion and does not absorb any liquids e.g. water or oil
- The chain, the lock body and supporting elements of the locking mechanism are made of specially hardened steel
- Ergonomically-shaped lock body
- Comes with a user-friendly reversible key

TECHNOLOGY



Ref. No.

EAN
4003318

mm

cm

Weight
g

Box
Qty

Ref. No.	EAN	mm	cm	Weight g	Box Qty
9210/85 black	88691 1	10	85	2440	2
9210/110 black	88692 8	10	110	3000	2
9210/140 black	88693 5	10	140	3650	1
9210/170 black	88694 2	10	170	4400	1

CITYCHAIN™ 1010

FEATURES



Plus



SECURITY LEVEL



TECHNICAL DATA

- 9 mm hexagonal chain with fabric sleeve to prevent damage to the bicycle's paintwork
- The chain, the lock body and supporting elements of the locking mechanism are made of specially hardened steel
- ABUS Plus cylinder for high protection against manipulations, e.g. picking
- Automatic cover for the keyhole against dirt and corrosion

TECHNOLOGY



TEST SEALS



1) Class B

Ref. No.

EAN
4003318

mm

cm

Weight
g

Box
Qty

Ref. No.	EAN	mm	cm	Weight g	Box Qty
1010/85 black	33559 4	9	85	1850	2
1010/110 black	12042 8	9	110	2200	2
1010/140 black	12527 0	9	140	2650	2
1010/170 black	12528 7	9	170	3200	2

STEEL-O-CHAIN™ 9809K

FEATURES



XPlus™



TECHNICAL DATA

- 9 mm thick square chain
- The chain, housing and structural parts of the locking mechanism are made of specially hardened steel
- Automatic keyhole cover to prevent corrosion and the ingress of dirt
- ABUS XPlus cylinder for the greatest protection against manipulation such as picking
- Two keys included

SECURITY LEVEL





TEST SEALS



TECHNOLOGY



Ref. No.	EAN 4003318	 mm	 cm	Weight g	Box Qty
9809K/85 black	95548 8	85	85	1750	2
9809K/110 black	95549 5	110	110	2250	2
9809K/140 black	95550 1	140	140	2800	2
9809K/170 black	95551 8	170	170	3050	2

STEEL-O-CHAIN™ 9808K

FEATURES



XPlus™



TECHNICAL DATA

- 8 mm square chain
- The chain, housing and structural parts of the locking mechanism are made of specially hardened steel
- Automatic keyhole cover to prevent corrosion and the ingress of dirt
- ABUS XPlus cylinder for the greatest protection against manipulation such as picking
- Two keys included

SECURITY LEVEL





TEST SEALS



TECHNOLOGY



Ref. No.	EAN 4003318	 mm	 cm	Weight g	Box Qty
9808K/85 black	95562 4	8	85	1750	2
9808K/110 black	95564 8	8	110	2250	2
9808K/140 black	95565 5	8	140	2800	2
9808K/170 black	95566 2	8	170	3050	2

8808C

SECURITY LEVEL



VERSIONS



russet red



jade green





Chain locks

TECHNICAL DATA

- 8 mm chain with fabric sleeve to prevent damage to the bicycle's paintwork
- The chain is made of specially hardened steel
- Two-component number reels guarantee long-term readability of the digits
- Individually configurable code

TECHNOLOGY



Ref. No.	EAN 4003318	 mm	 cm	Weight g	Box Qty
8808C/85 black	61490 3	8	85	1990	2
8808C/85 russet red	61491 0	8	85	1990	2
8808C/85 jade green	61492 7	8	85	1990	2
8808C/110 black	61494 1	8	110	2370	2

IVEN CHAIN 8210

SECURITY LEVEL



FEATURES



TECHNICAL DATA

- 8 mm square chain with a functional, durable and highly flexible IvyTex synthetic fibre sleeve prevents damage to paintwork
- The sleeve offers very high protection against abrasion and does not absorb any liquids e.g. water or oil
- The chain, the lock body and supporting elements of the locking mechanism are made of specially hardened steel

TECHNOLOGY



TEST SEALS



1) 24192

Ref. No.	EAN 4003318	⌀ ↑ mm	● ↔ cm	Weight g	Box Qty
8210/85 black	55152 9	8	85	1800	2
8210/110 black	55153 6	8	110	2200	2
8210/140 black	88288 3	8	140	3185	2

IVERA CHAIN 7210 COLOR

FEATURES



Bracket IVERA RBU



SECURITY LEVEL



VERSIONS



sparkling orange



diving blue



crossing grey

Ref. No.	EAN 4003318	⌀ mm	●—● cm	Weight g	Box Qty
7210/85 sparkling orange	87777 3	7	85	1300	2
7210/85 racing yellow	87778 0	7	85	1300	2
7210/85 diving blue	87779 7	7	85	1300	2
7210/85 crossing grey	87780 3	7	85	1300	2
7210/110 sparkling orange	87783 4	7	110	1500	2
7210/110 racing yellow	87782 7	7	110	1500	2
7210/110 diving blue	87784 1	7	110	1500	2
7210/110 crossing grey	87781 0	7	110	1500	2
Bracket IVERA RBU	58497 8			125	1

TECHNICAL DATA

- 7 mm square chain with functional, long-life and highly-flexible mesh sleeve to prevent damage to the bicycle's paintwork
- The sleeve offers very high protection against abrasion and does not absorb any liquids e.g. water or oil
- The chain, the case as well as supporting elements of the locking mechanism are made of specially hardened steel

TECHNOLOGY



IVERA CHAIN 7210

FEATURES



Bracket IVERA RBU



SECURITY LEVEL



Ref. No.	EAN 4003318	⌀ mm	●—● cm	Weight g	Box Qty
7210/85	55141 3	7	85	1300	2
7210/110	55142 0	7	110	1500	2
Bracket IVERA RBU	58497 8			125	1

TECHNICAL DATA

- 7 mm square chain with a functional, durable and highly flexible IvyTex synthetic fibre sheath prevents damage to paintwork
- The sleeve offers very high protection against abrasion and does not absorb any liquids e.g. water or oil
- The chain, the lock body and supporting elements of the locking mechanism are made of specially hardened steel

TECHNOLOGY



STEEL- O- CHAIN™ 8807K

SECURITY LEVEL



FEATURES





TECHNICAL DATA

- 7 mm thick square chain with textile sleeve that prevents damage to paintwork
- The chain, the lock body and supporting elements of the locking mechanism are made of specially hardened steel

TECHNOLOGY



Ref. No.	EAN 4003318	 mm	 cm	Weight g	Box Qty
8807K/85 black	71195 4	7	85	1600	2
8807K/110 black	82519 4	7	110	1900	2

TRESOR 1385

SECURITY LEVEL



VERSIONS



aqua



coral



brown



Chain locks

TECHNICAL DATA

- 7 mm square chain with fabric sleeve to prevent damage to the bicycle's paintwork
- The chain is made of specially hardened steel
- Two component moulded digits guarantee life-long visibility
- Special touch protection for higher security against unauthorized access to the code through manipulation of the mechanism
- Individually settable code

TECHNOLOGY



Ref. No.	EAN 4003318	 mm	 cm	Weight g	Box Qty
1385/85 black	48566 4	7	85	1050	2
1385/85 aqua	48567 1	7	85	1050	2
1385/85 coral	48568 8	7	85	1050	2
1385/85 brown	48569 5	7	85	1050	2
1385/110 black	48628 9	7	110	1350	2

TRESOR 1385 COLOR

SECURITY LEVEL



VERSIONS



grey star



blue mask



grey lightning





TECHNICAL DATA

- 6 mm square chain with fabric sleeve to prevent damage to the bicycle's paintwork
- The chain is made of specially hardened steel
- Two component moulded digits guarantee life-long visibility
- Special touch protection for higher security against unauthorized access to the code through manipulation of the mechanism
- Individually settable code

TECHNOLOGY



Ref. No.	EAN 4003318	 mm	 cm	Weight g	Box Qty
1385/75 grey star	88010 0	6	75	750	6
1385/75 blue mask	88011 7	6	75	750	6
1385/75 grey lightning	88012 4	6	75	750	6
1385/75 cherry heart	88013 1	6	75	750	6

TRESOR 1385 NEON

SECURITY LEVEL



VERSIONS



black



neon green



neon orange



neon pink



Chain locks

TECHNICAL DATA

- 6 mm square chain with fabric sleeve to prevent damage to the bicycle's paintwork
- The chain is made of specially hardened steel
- Two component moulded digits guarantee life-long visibility
- Special touch protection for higher security against unauthorized access to the code through manipulation of the mechanism
- Individually settable code

TECHNOLOGY



Ref. No.	EAN 4003318	 mm	 cm	Weight g	Box Qty
1385/75 black	51133 2	6	75	750	6
1385/75 neon green	71263 0	6	75	750	6
1385/75 neon blue	71262 3	6	75	750	6
1385/75 neon orange	71264 7	6	75	750	6
1385/75 neon pink	71265 4	6	75	750	6

CATENA 6806K

FEATURES



Bracket QST



SECURITY LEVEL



VERSIONS



aqua



coral



brown

Ref. No.

EAN
4003318

mm

cm

Weight
g

Box
Qty

6806K/85 black	90169 0	6	85	920	6
6806K/85 black QST	95483 2	6	85	1150	6
6806K/85 aqua	90282 6	6	85	920	6
6806K/85 coral	90284 0	6	85	920	6
6806K/85 brown	90283 3	6	85	920	6
6806K/110 black	82511 8	6	110	1160	6
6806K/110 black QST	95479 5	6	110	1390	6
Bracket QST	61493 4			260	6

TECHNICAL DATA

- 6 mm thick square chain with textile sleeve that prevents damage to paintwork
- The chain is made of specially hardened steel

TECHNOLOGY



CATENA 6806K NEON

FEATURES



Bracket QST



SECURITY LEVEL



VERSIONS



neon green



neon blue



neon orange

Ref. No.

EAN
4003318

mm

cm

Weight
g

Box
Qty

6806K/85 neon green	90290 1	6	85	920	6
6806K/85 neon blue	90289 5	6	85	920	6
6806K/85 neon orange	90291 8	6	85	920	6
6806K/85 neon pink	90292 5	6	85	920	6
Bracket QST	61493 4			260	6

TECHNICAL DATA

- 6 mm square chain with textile sleeve to protect against damage to the paintwork
- The chain and the housing are made of specially hardened steel

TECHNOLOGY



CATENA 6806 COLOR

FEATURES



Bracket QST



SECURITY LEVEL



VERSIONS



blue mask



grey lightning





grey star

TECHNICAL DATA

- 6 mm square chain with fabric sleeve to prevent damage to the bicycle's paintwork
- The chain as well as case are made of specially hardened steel

TECHNOLOGY



Ref. No.	EAN 4003318	 mm	 cm	Weight g	Box Qty
6806K/85 cherry heart	90288 8	6	85	920	6
6806K/85 blue mask	90286 4	6	85	920	6
6806K/85 grey lightning	90287 1	6	85	920	6
6806K/85 grey star	90285 7	6	85	920	6
Bracket QST	61493 4			260	6

CATENA 6806K REFLECTIVE

FEATURES



Bracket QST



SECURITY LEVEL





TECHNICAL DATA

- 6 mm thick square chain with textile sleeve that prevents damage to paintwork
- The chain is made of specially hardened steel

TECHNOLOGY



Ref. No.	EAN 4003318	 mm	 cm	Weight g	Box Qty
6806K/85 reflective	69104 1	6	85	920	6
6806K/110 reflective	69105 8	6	110	1160	6
Bracket QST	61493 4			260	6

STEEL-O-CHAIN™ 5805K

FEATURES



TECHNICAL DATA

- 5 mm square chain with textile sleeve to protect against damage to the paintwork
- The chain is made of specially hardened steel

SECURITY LEVEL



VERSIONS



blue



red



lime



pink



Ref. No.

EAN
4003318

mm

cm

Weight
g

Box
Qty

5805K/75 black

71205 0

5

75

590

6

5805K/75 blue

72490 9

5

75

590

6

5805K/75 red

72489 3

5

75

590

6

5805K/75 lime

72491 6

5

75

590

6

5805K/75 pink

72492 3

5

75

590

6

5805K/110 black

72493 0

5

110

780

6

STEEL-O-CHAIN™ 5805C

SECURITY LEVEL



VERSIONS



blue



red



lime



pink



TECHNICAL DATA

- 5 mm thick square chain with textile sleeve that prevents damage to paintwork
- The chain is made of specially hardened steel
- Two-component number reels guarantee long-term readability of the digits
- The number code can be set individually

TECHNOLOGY

Ref. No.

EAN
4003318

mm

cm

Weight
g

Box
Qty

5805C/75 black

71206 7

5

75

500

6

5805C/75 blue

72494 7

5

75

500

6

5805C/75 red

72495 4

5

75

500

6

5805C/75 lime

72496 1

5

75

500

6

5805C/75 pink

72497 8

5

75

500

6

5805C/110 black

72498 5

5

110

720

6

STEEL- O- CHAIN™ 4804K

SECURITY LEVEL



FEATURES



VERSIONS



blue



red



lime



pink

Chain locks

TECHNICAL DATA

- 4 mm thick square chain with textile sleeve that prevents damage to paintwork
- The chain is made of specially hardened steel

TECHNOLOGY



Ref. No.	EAN 4003318	⌀ ↑ mm	●—○ cm	Weight g	Box Qty
4804K/75 black	72483 1	4	75	380	6
4804K/75 blue	72484 8	4	75	380	6
4804K/75 red	72485 5	4	75	380	6
4804K/75 lime	72486 2	4	75	380	6
4804K/75 pink	72487 9	4	75	380	6
4804K/110 black	72488 6	4	110	520	6

STEEL-O-CHAIN™ 4804C SYMBOLS



TECHNICAL DATA

- 4 mm square chain with fabric sleeve to prevent damage to the bicycle's paintwork
- The chain is made of specially hardened steel
- Playfully easy use for children due to symbols instead of digits
- Individually settable code

TECHNOLOGY



SECURITY LEVEL

VERSIONS



symbols blue



symbols pink



symbols red

Ref. No.

EAN
4003318



mm



cm

Weight
g

Box
Qty

4804C/75 blue SYMBOLS

86809 2

4

75

360

6

4804C/75 pink SYMBOLS

86810 8

4

75

360

6

4804C/75 red SYMBOLS

87499 4

4

75

360

6

4804C/75 lime SYMBOLS

87498 7

4

75

360

6

STEEL-O-CHAIN™ 4804C



TECHNICAL DATA

- 4 mm thick square chain with textile sleeve that prevents damage to paintwork
- The chain is made of special hardened steel
- Individually settable code

TECHNOLOGY



SECURITY LEVEL

VERSIONS



black



blue



red



lime



pink

Ref. No.

EAN
4003318



mm



cm

Weight
g

Box
Qty

4804C/75 black

71617 1

4

75

360

6

4804C/75 blue

71616 4

4

75

360

6

4804C/75 red

72468 8

4

75

360

6

4804C/75 lime

72480 0

4

75

360

6

4804C/75 pink

72481 7

4

75

360

6

4804C/110 black

72482 4

4

110

480

6

1500 WEB

FEATURES



TECHNICAL DATA

- 4 mm round chain with textile sleeve to protect against damage to the paintwork
- The chain is made of special steel

TECHNOLOGY



SECURITY LEVEL



VERSIONS



lime



orange



red



white



coral

Ref. No.

EAN
4003318

Version



mm



cm

Weight
g

Box
Qty

Ref. No.	EAN 4003318	Version	mm	cm	Weight g	Box Qty
1500/60 web black	56345 4		4	60	230	12
1500/60 web lime	56344 7		4	60	230	12
1500/60 web orange	56920 3		4	60	230	12
1500/60 web red	56343 0		4	60	230	12
1500/60 web white	56921 0		4	60	230	12
1500/60 web coral	57895 3		4	60	230	12
1500/60 web color	57658 4	4x lime, orange, red	4	60	230	12
1500/110 web black	56346 1		4	110	360	12
1500/110 web color	57659 1	4x lime, orange, red	4	110	360	12

1200 WEB

SECURITY LEVEL



VERSIONS



lime



orange



red



white



pink

Ref. No.

EAN
4003318

Version



mm



cm

Weight
g

Box
Qty

Ref. No.	EAN 4003318	Version	mm	cm	Weight g	Box Qty
1200/60 web black	56341 6		4	60	200	12
1200/60 web lime	56340 9		4	60	200	12
1200/60 web orange	56922 7		4	60	200	12
1200/60 web red	56339 3		4	60	200	12
1200/60 web white	56924 1		4	60	200	12
1200/60 web coral	57893 9		4	60	200	12
1200/60 web color	57656 0	4x lime, orange, red	4	60	200	12
1200/110 web black	56342 3		4	110	330	12
1200/110 web color	57657 7	4x lime, orange, red	4	110	330	12

TECHNICAL DATA

- 4 mm thick rounded chain with textile sleeve to prevent damage to paintwork
- The chain is made of specially hardened steel

GOOSE LOCK



G O O S E
L O C K

6206K GOOSE LOCK



mint

Page 65



black

Page 65



rosemauve

Page 65



flint

Page 65

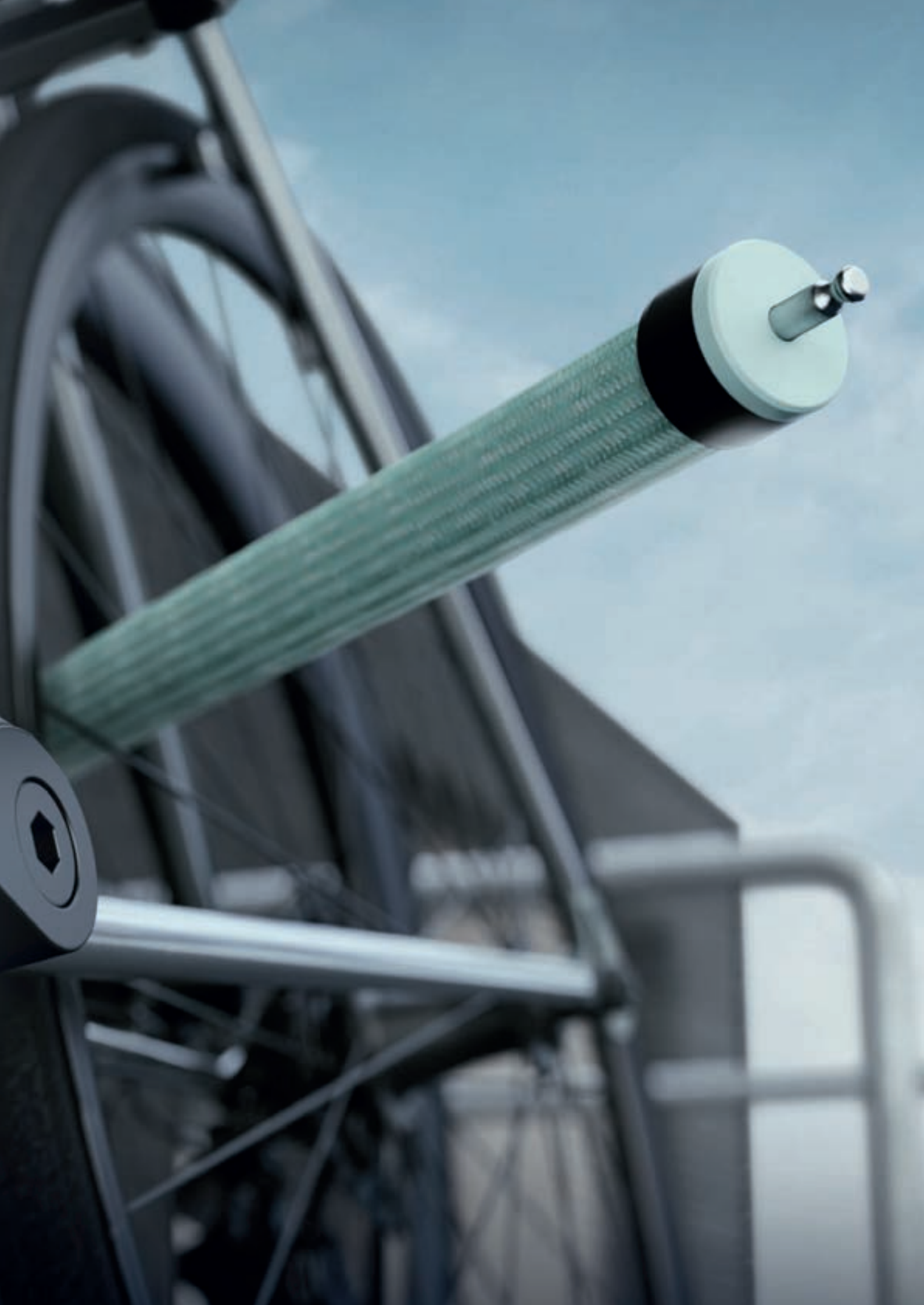

6206K GOOSE LOCK

NEW

SECURITY LEVEL



VERSIONS



black



rosemauve



flint



TECHNICAL DATA

- 6 mm thick chain with functional, durable and highly flexible textile fibre sheathing
- Dimensionally stable and flexible chain lock with textile feel
- Soft coating provides strong protection against wear
- The chain, housing and structural parts of the locking mechanism are made of specially hardened steel

TECHNOLOGY



Ref. No.	EAN 4003318	⌀ mm	●—● cm	Weight g	Box Qty
6206K/85 black	95546 4	6	85	920	6
6206K/110 black	95547 1	6	110	1120	6
6206K/110 rosemauve	96156 4	6	110	1120	6
6206K/110 mint	96158 8	6	110	1120	6
6206K/110 flint	96157 1	6	110	1120	6

Goose Lock

STEEL-O-FLEX LOCKS



STEEL-O-FLEX™

950



black

Page 68

IVEN STEEL-O-FLEX™

8200



black

Page 68

IVERA STEEL-O-FLEX™

7200



black

Page 69

CENTURO

860



black

Page 69

PHANTOM™

8960



black

Page 70

STEEL-O-FLEX™

RAYDO PRO 1460



black

Page 71

STEEL-O-FLEX™

TRESOR 1360



black

Page 72

MICROFLEX

6615K



black

Page 73

TRESORFLEX

6615C



black

Page 73

STEEL-O-FLEX™ 950

FEATURES



Plus



Bracket UGH 02

SECURITY LEVEL



Ref. No.

EAN
4003318



mm



cm

Weight
g

Box
Qty

950/100

25715 5

25

100

1540

2

Bracket UGH 02

26624 9

80

1



TECHNICAL DATA

- 25 mm thick, overlapping steel shells protect the internal steel cable
- Synthetic coating to prevent damage to the bicycle's paintwork
- The steel shells, the case as well as supporting elements of the locking mechanism are made of specially hardened steel
- ABUS Plus cylinder for high protection against manipulations, e.g. picking
- Manually operated cover for the keyhole against dirt and corrosion

TEST SEALS



IVEN STEEL-O-FLEX™ 8200

FEATURES



Bracket UGH 02

SECURITY LEVEL



Ref. No.

EAN
4003318



mm



cm

Weight
g

Box
Qty

8200/85

55148 2

25

85

1340

2

8200/110

55149 9

25

110

1580

2

Bracket UGH 02

26624 9

80

1



TEST SEALS



TECHNICAL DATA

- New, functional, durable and highly flexible synthetic sleeve prevents damage to paintwork
- 25 mm thick, overlapping steel shells protect the internal steel cable
- The steel shells, the case as well as supporting elements of the locking mechanism are made of specially hardened steel
- Ergonomic lock body with softcase technology to prevent damage to the bicycle's paintwork

TECHNOLOGY



IVERA STEEL- O- FLEX™ 7200

FEATURES



Ivera RBU Bracket

SECURITY LEVEL



TECHNICAL DATA

- 22 mm thick, overlapping steel shells protect the internal steel cable
- The steel shells, the housing and the structural parts of the locking mechanism are manufactured using specially hardened steel
- Ergonomic lock body with softcase technology to prevent damage to the bicycle's paintwork

TECHNOLOGY



TEST SEALS



Ref. No.	EAN 4003318	 mm	 cm	Weight g	Box Qty
7200/85	55137 6	22	85	700	6
7200/85 + RBU	55139 0	22	85	840	6
7200/110	55138 3	22	110	860	6
7200/110 + RBU	55140 6	22	110	1000	6
Bracket IVERA RBU	58497 8			125	1

CENTURO 860

FEATURES



Bracket QuickSnap RBU

SECURITY LEVEL



TECHNICAL DATA

- 20 mm thick, overlapping steel shells protect the internal steel cable
- Plastic coating to prevent damage to the bicycle's paintwork
- The steel shells, the case as well as supporting elements of the locking mechanism are made of specially hardened steel

TECHNOLOGY



TEST SEALS



Ref. No.	EAN 4003318	 mm	 cm	Weight g	Box Qty
860/85	31495 7	20	85	780	6
860/85 QS RBU	31493 3	20	85	825	6
860/110	31496 4	20	110	980	6
860/110 QS RBU	31494 0	20	110	1025	6
860/85 QS	31528 2	20	85	840	6
Bracket QuickSnap RBU	31487 2			40	6

PHANTOM™ 8960

SECURITY LEVEL



FEATURES



Bracket TexFL



Bracket KF



TECHNICAL DATA



- 17 mm thick, overlapping steel shells protect the internal steel cable
- Plastic coating to prevent damage to the bicycle's paintwork
- The shells, body and the structural parts of the locking mechanism are made of specially hardened steel
- ABUS Extra Classe (EC) automatic cylinder with coded reversible key

TECHNOLOGY



TEST SEALS



Ref. No.	EAN 4003318			Weight g	Box Qty
		mm	cm		
8960/85 KF	78595 5	17	85	700	6
8960/85 TexFL	39680 9	17	85	720	6
8960/110 TexFL	39683 0	17	110	920	6
Bracket KF	12433 4			42	6
Bracket TexFL	39730 1			77	1

STEEL-0-FLEX™ RAYDO PRO 1460

SECURITY LEVEL



FEATURES



Combo light



Bracket TexKF Mini



Bracket KF



TECHNICAL DATA



- 20 mm thick, overlapping steel shells protect the internal steel cable
- Plastic coating to prevent damage to the bicycle's paintwork
- The steel sleeves are manufactured using specially hardened steel
- Individually configurable code
- Press'n Shine function – LED-lit number reel for easy handling in the dark

TECHNOLOGY



TEST SEALS



Ref. No.	EAN 4003318	 mm	 cm	Weight g	Box Qty
1460/85 KF	59216 4	20	85	780	6
1460/85 TexKF	59217 1	20	85	780	6
Bracket KF	12433 4			42	6
Bracket TexKF Mini	23265 7			70	1

STEEL- O- FLEX™ TRESOR 1360

SECURITY LEVEL



TECHNICAL DATA



- 20 mm thick, overlapping steel shells protect the internal steel cable
- Plastic coating to prevent damage to the bicycle's paintwork
- Two-component number reels ensure long-term readability of the digits
- Special touch protection for increased security against unauthorised access to the code through manipulation of the mechanism
- Dark-touch function facilitates use in the dark thanks to special imprinting
- Individually configurable code

TECHNOLOGY



TEST SEALS



Ref. No.	EAN 4003318			Weight g	Box Qty
		mm	cm		
1360/85 black	42935 4	20	85	680	6
1360/110 black	42934 7	20	110	880	6

MICROFLEX 6615K

FEATURES



Bracket SCMU

Bracket SCLL



TECHNICAL DATA



- 15 mm thick, overlapping steel shells protect the internal steel cable
- Plastic coating to prevent damage to the bicycle's paintwork

TECHNOLOGY



SECURITY LEVEL



Ref. No.	EAN 4003318	 mm	 cm	Weight g	Box Qty
6615K/85/15 black	13410 4	15	85	540	6
6615K/85/15 black SCMU	13408 1	15	85	580	6
6615K/85/15 black SCLL	86174 1	15	85	580	6
6615K/120/15 black	13412 8	15	120	700	6
6615K/120/15 black SCMU	13409 8	15	120	760	6
6615K/120/15 black SCLL	86172 7	15	120	760	6
Bracket SCLL 6K	87984 5			47	12
Bracket Snap Cage MU 6K	20079 3			40	12

TRESORFLEX 6615C

FEATURES



Bracket SCMU

Bracket SCLL



TECHNICAL DATA



- 15 mm thick, overlapping steel shells protect the internal steel cable
- Plastic coating to prevent damage to the bicycle's paintwork
- Two-component number reels ensure long-term readability of the digits
- Special touch protection for increased security against unauthorised access to the code through manipulation of the mechanism
- Dark-touch function facilitates use in the dark thanks to special imprinting
- Individually configurable code

TECHNOLOGY



SECURITY LEVEL



Ref. No.	EAN 4003318	 mm	 cm	Weight g	Box Qty
6615C/85/15 black	13659 7	15	85	560	6
6615C/85/15 black SCMU	13657 3	15	85	705	6
6615C/85/15 black SCLL	86173 4	15	85	705	6
6615C/120/15 black	13780 8	15	120	720	6
6615C/120/15 black SCMU	13658 0	15	120	780	6
6615C/120/15 black SCLL	86171 0	15	120	780	6
Bracket SCLL 6C	87983 8			47	12
Bracket Snap Cage MU 6C	20113 4			40	12

COIL CABLE AND CABLE LOCKS



**PHANTOM™
8950**



black

Page 78

**RAYDO PRO
1450**



black

Page 79

**BOOSTER
6512K**



black

Page 80

**TRESOR
6512C**



black

Page 80

**PRIMO
5510K**



black

Page 81

**NUMERO
5510C**



black

Page 81

**STAR
4508K**



black

Page 82



blue

Page 82



red

Page 82



green

Page 82

**STAR
4508C**



black

Page 82



blue

Page 82



red

Page 82



green

Page 82

3506K



black

Page 83



blue

Page 83



orange

Page 83



red

Page 83



green

Page 83



pink

Page 83



silver

Page 83



black

Page 83



blue

Page 83



orange

Page 83



red

Page 83



green

Page 83



pink

Page 83

3506C



silver

Page 83



black

Page 84

**IVERA CABLE
7220**



black

Page 86

**RACER
6412K**



black

Page 86

**TRESOR
6412C**



black

Page 87

**PRIMO
5410K**



black

Page 87

**NUMERINO
5410C**



black

Page 88

4408K



blue

Page 88



red

Page 88



green

Page 88



black

Page 88

4408C



blue

Page 88



red

Page 88



green

Page 88

3406K



black

Page 89



blue

Page 89



orange

Page 89



red

Page 89



green

Page 89



pink

Page 89



silver

Page 89

3406C



black

Page 89



blue

Page 89



orange

Page 89



red

Page 89



green

Page 89



pink

Page 89



silver

Page 89

PHANTOM™ 8950

SECURITY LEVEL



FEATURES



Bracket KF



Bracket TexKF Mini



Bracket TexFL





TECHNICAL DATA

- 12 or 15 mm thick, high-quality and super flexible spiral cable
- Plastic coating in matte black look to prevent damage to the bicycle's paintwork
- ABUS Extra Classe (EC) automatic cylinder with coded reversible key

TECHNOLOGY



Ref. No.	EAN 4003318	 mm	 cm	Weight g	Box Qty
8950/180 KF	39685 4	12	180	645	6
8950/180 TexKF	39684 7	12	180	655	6
8950/180 TexFL	39802 5	12	180	665	6

RAYDO PRO 1450

SECURITY LEVEL



FEATURES



Bracket TexKF Mini



TECHNICAL DATA

- 12 mm thick, high-quality and super flexible spiral cable
- Plastic coating to prevent damage to the bicycle's paintwork
- Individually configurable code
- Press'n Shine function – LED-lit number reel for easy handling in the dark

TECHNOLOGY



Coil cable and cable locks

Ref. No.	EAN 4003318	 mm	 cm	Weight g	Box Qty
1450/185 black TexKF	59214 0	12	185	718	6

BOOSTER 6512K

FEATURES



Bracket SCM U



TECHNICAL DATA

- 12 mm thick, high-quality and super flexible spiral cable
- Plastic coating to prevent damage to the bicycle's paintwork

TECHNOLOGY



SECURITY LEVEL



Ref. No.

EAN
4003318



mm



cm

Weight
g

Box
Qty

6512K/180 black

13400 5

12

180

531

6

6512K/180 black SCM U

13399 2

12

180

573

6

TRESOR 6512C

FEATURES



Bracket SCM U



TECHNICAL DATA

- 12 mm thick, high-quality and super flexible spiral cable
- Plastic coating to prevent damage to the bicycle's paintwork
- 2-component number reels guarantee long-term readability of the digits
- Individually configurable code

TECHNOLOGY



SECURITY LEVEL



Ref. No.

EAN
4003318



mm



cm

Weight
g

Box
Qty

6512C/180 black

13414 2

12

180

600

6

6512C/180 black SCM U

13415 9

12

180

549

6

PRIMO 5510K

FEATURES



Bracket SCMU



TECHNICAL DATA



- 10 mm thick, high-quality and super flexible spiral cable
- Plastic coating to prevent damage to the bicycle's paintwork

TECHNOLOGY



SECURITY LEVEL



Ref. No.	EAN 4003318	 mm	 cm	Weight g	Box Qty
5510K/180 black	14260 4	10	180	460	6
5510K/180 black SCMU	14245 1	10	180	508	6

NUMERO 5510C

FEATURES



Bracket SCMU



TECHNICAL DATA



- 10 mm thick, high-quality and super flexible spiral cable
- Plastic coating to prevent damage to the bicycle's paintwork
- Dark-touch function facilitates use in the dark thanks to special imprinting
- Two-component number reels ensure long-term readability of the digits
- Individually configurable code

TECHNOLOGY



SECURITY LEVEL



Ref. No.	EAN 4003318	 mm	 cm	Weight g	Box Qty
5510C/180 black	16524 5	10	180	459	6
5510C/180 black SCMU	16523 8	10	180	508	6

STAR 4508K

FEATURES



TECHNICAL DATA

- 8 mm thick, high-quality and super flexible spiral cable
- Plastic coating to prevent damage to the bicycle's paintwork

TECHNOLOGY



SECURITY LEVEL

VERSIONS



blue



red



green

Ref. No.

EAN
4003318



mm



cm

Weight
g

Box
Qty

4508K/150 black

20016 8

8

150

280

12

4508K/150 blue

40775 8

8

150

280

12

4508K/150 red

40776 5

8

150

280

12

4508K/150 green

40777 2

8

150

280

12

STAR 4508C

SECURITY LEVEL

VERSIONS



blue



red



green

Ref. No.

EAN
4003318



mm



cm

Weight
g

Box
Qty

4508C/150 black

20019 9

8

150

260

12

4508C/150 blue

40778 9

8

150

260

12

4508C/150 red

40779 6

8

150

260

12

4508C/150 green

40780 2

8

150

260

12

TECHNICAL DATA

- 8 mm thick, high-quality and super flexible spiral cable
- Plastic coating to prevent damage to the bicycle's paintwork
- Dark-touch function facilitates use in the dark thanks to special imprinting
- Individually configurable code

TECHNOLOGY



3506K

FEATURES



TECHNICAL DATA

- 6 mm thick and super flexible spiral cable
- Plastic coating to prevent damage to the bicycle's paintwork

SECURITY LEVEL



VERSIONS



blue



orange



red



green



pink



silver

Ref. No.

EAN
4003318

Version



mm



cm

Weight
g

Box
Qty

Ref. No.	EAN	Version	mm	cm	Weight g	Box Qty
3506K/120 black	40769 7		6	120	206	12
3506K/120 color	40770 3	2x all colors except black	6	120	206	12
3506K/180 black	40771 0		6	180	206	12

3506C



TECHNICAL DATA

- 6 mm thick and super flexible spiral cable
- Plastic coating to prevent damage to the bicycle's paintwork

SECURITY LEVEL



VERSIONS



blue



orange



red



green



pink



silver

Ref. No.

EAN
4003318

Version



mm



cm

Weight
g

Box
Qty

Ref. No.	EAN	Version	mm	cm	Weight g	Box Qty
3506C/120 black	40772 7		6	120	174	12
3506C/120 color	40773 4	2x all colors except black	6	120	174	12

IVERA CABLE 7220

SECURITY LEVEL



FEATURES



Bracket IVERA RBU



TECHNICAL DATA



- 20 mm thick, high-quality steel cable
- New, functional, durable and highly flexible Ivy synthetic-fibre coating to prevent damage to the paintwork
- The body and structural parts of the locking mechanism are manufactured using specially hardened steel

TECHNOLOGY



LOGOS D'AGRÉMENT



Ref. No.	EAN 4003318			Weight g	Box Qty
		mm	cm		
7220/85 black	55145 1	20	85	660	6
Bracket IVERA RBU	58497 8			125	1



RACER 6412K

FEATURES



Bracket SCMU



TECHNICAL DATA

- 12 mm thick steel cable
- Plastic coating to prevent damage to the bicycle's paintwork



TECHNOLOGY



SECURITY LEVEL

VERSIONS



Ref. No.	EAN 4003318	 mm	 cm	Weight g	Box Qty
6412K/85 black	40804 5	12	85	386	6
6412K/85 black SCMU	40805 2	12	85	387	6
6412K/120 black	63491 8	12	120	492	6

TRESOR 6412C

FEATURES



Bracket SCMU



TECHNICAL DATA

- 12 mm thick steel cable
- Plastic coating to prevent damage to the bicycle's paintwork
- Two component moulded digits guarantee life-long visibility
- Individually configurable code



TECHNOLOGY



SECURITY LEVEL

VERSIONS



Ref. No.	EAN 4003318	 mm	 cm	Weight g	Box Qty
6412C/85 black	40807 6	12	85	396	6
6412C/85 black SCMU	40808 3	12	85	441	6
6412C/85 black SCMU	63489 5	12	120	503	6

PRIMO 5410K

FEATURES



Bracket SCMU



TECHNICAL DATA



- 10 mm thick steel cable
- Plastic coating to prevent damage to the bicycle's paintwork

TECHNOLOGY



SECURITY LEVEL



Ref. No.	EAN 4003318	 mm	 cm	Weight g	Box Qty
5410K/85 black	40798 7	10	85	278	6
5410K/85 black SCMU	40799 4	10	85	330	6

NUMERINO 5410C



TECHNICAL DATA

- 10 mm thick steel cable
- Plastic coating to prevent damage to the bicycle's paintwork
- Two component moulded digits guarantee life-long visibility
- Individually configurable code

TECHNOLOGY



SECURITY LEVEL



Ref. No.	EAN 4003318	 mm	 cm	Weight g	Box Qty
5410C/85 black	40801 4	10	85	276	6

4408K

FEATURES



TECHNICAL DATA

- 8 mm thick steel cable
- Plastic coating to prevent damage to the bicycle's paintwork

SECURITY LEVEL



VERSIONS



blue



red



green

Ref. No.

EAN
4003318



mm



cm

Weight
g

Box
Qty

4408K/65 black

40790 1

8

65

271

12

4408K/65 blue

40791 8

8

65

271

12

4408K/65 red

40792 5

8

65

271

12

4408K/65 green

40793 2

8

65

271

12

4408C

TECHNICAL DATA

- 8 mm thick steel cable
- Plastic coating to prevent damage to the bicycle's paintwork

SECURITY LEVEL



VERSIONS



blue



red



green

Ref. No.

EAN
4003318



mm



cm

Weight
g

Box
Qty

4408C/65 black

40794 9

8

65

271

12

4408C/65 blue

40795 6

8

65

271

12

4408C/65 red

40796 3

8

65

271

12

4408C/65 green

40797 0

8

65

271

12

TECHNOLOGY



3406K

FEATURES



TECHNICAL DATA

- 6 mm thick steel cable
- Plastic coating to prevent damage to the bicycle's paintwork

SECURITY LEVEL



VERSIONS



blue



orange



red





green



pink



silver

Ref. No.	EAN 4003318	Version	 mm	 cm	Weight g	Box Qty
3406K/55 black	40782 6		6	55	139	12
3406K/55 color	40785 7	2x all colors except black	6	55	139	12

3406C

TECHNICAL DATA

- 6 mm thick steel cable
- Plastic coating to prevent damage to the bicycle's paintwork

SECURITY LEVEL



VERSIONS



blue



orange



red





green



pink



silver

Ref. No.	EAN 4003318	Version	 mm	 cm	Weight g	Box Qty
3406C/55 black	40787 1		6	55	114	12
3406C/55 color	40789 5	2x all colors except black	6	55	114	12

FRAME LOCKS AND BATTERY LOCKS



GRANIT XPLUS™

6950



black

Page 94

**PRO AMPARO
4750X / XL**



black

Page 96

**PRO AMPARO
4750S / SL**



black

Page 97

4650X / XL



black

Page 98

4650S / SL



black

Page 98

**PRO TECTIC™
4960**



black

Page 99

**TECTIC™
496**



black

Page 99

**ACH 2.0
ADAPTOR CHAIN**



black

Page 100

**ADAPTOR
CABLE**



black

Page 100

**IVYTEX
ADAPTOR CHAIN**



black

Page 101



crossing grey

Page 101

FRAME LOCKS

We want to help you find the right frame lock for your customer's bike even faster in the future. The dimensions below should help you with this.

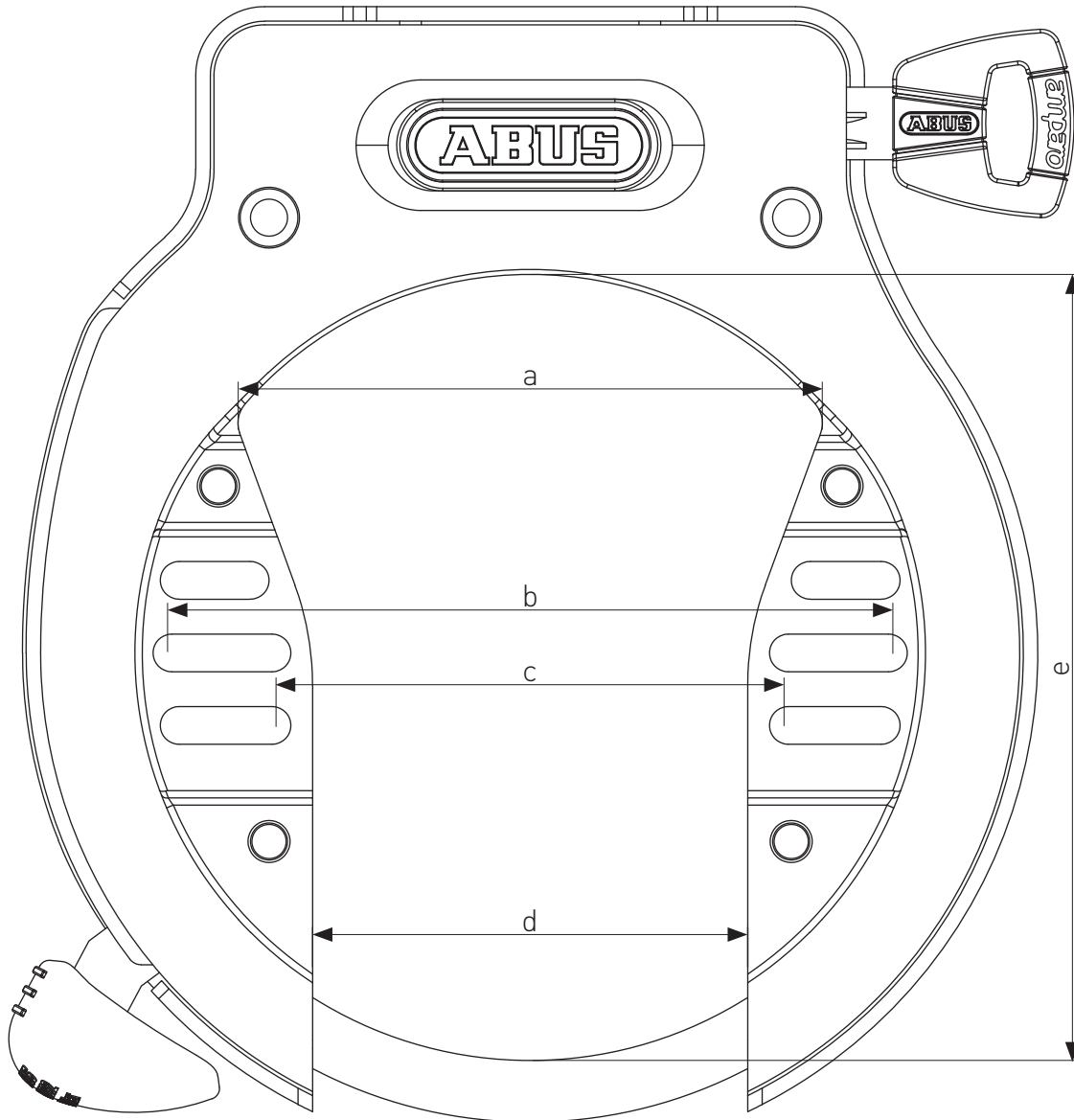

- a Maximum mudguard width
- b Maximum hole spacing of rear mounting points
- c Minimum hole spacing of rear mounting points
- d Maximum tire width
- e Maximum clearance heights (top of mudguard vs rim)

You will find an overview of all dimensions on the next page. In addition, you will also find all relevant dimensions on each product page in the tables.

Ref. No.	EAN	a	b	c	d	e	Weight	Box Qty
	4003318	mm	mm	mm	mm	mm	g	

ALL FRAME LOCK DIMENSIONS IN OVERVIEW

6950M AM

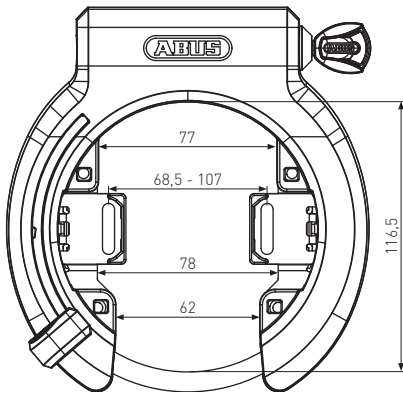

4750X / 4750XL

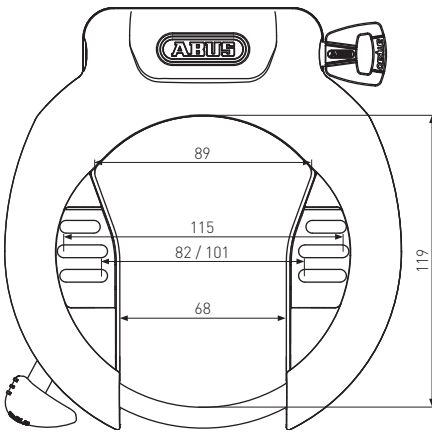

4750S / 4750SL

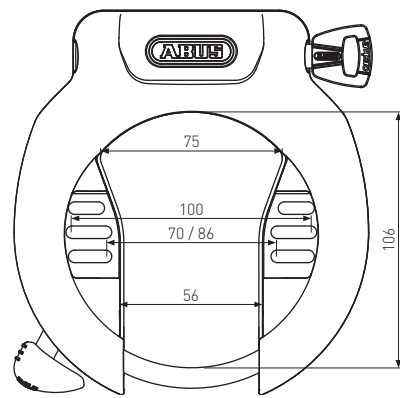

4650X / 4650XL

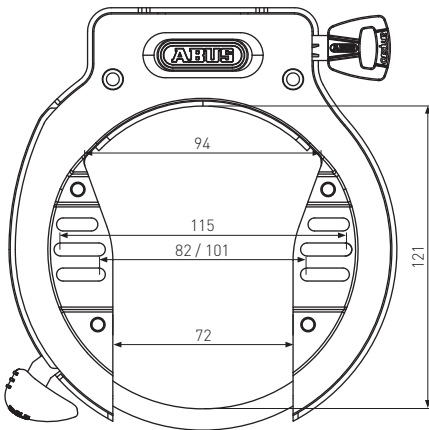

4650S / 4650SL

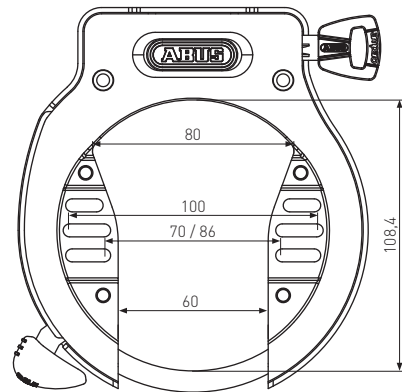

4960

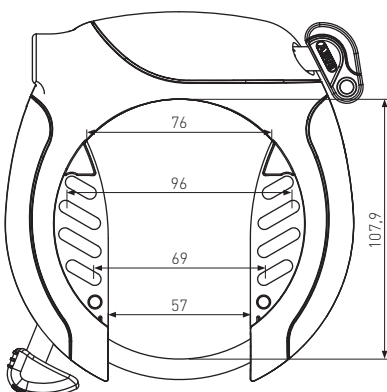

496

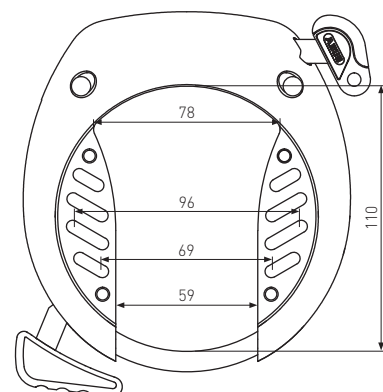

Frame locks and battery locks

All dimensions in mm.

GRANIT XPLUS™ 6950

SECURITY LEVEL



FEATURES



All Mounting Plate



FMU 6950

Adapter plate 6950



TECHNICAL DATA

- 8.5 mm thick locking shackle
- The shackle, housing and structural parts of the locking mechanism are made of specially hardened steel
- Closing mechanism for simple connection of accessories in the lock housing
- ABUS XPlus cylinder for the greatest protection against manipulation such as picking
- In the R variant, the key remains in the cylinder when the lock is opened; in the NR variant, it can be pulled out
- Hole spacing for mounting is universally adjustable

TECHNOLOGY



TEST SEALS



1) 38581 2) Only for "R" version

Ref. No.	EAN 4003318	a	b	c	d	e	Weight g	Box Qty
6950M AM R BK XPlus™	61914 4	77	68,5-107	78	62	116,5	770	1
6950M AM R BK XPlus™ OE	61928 1	77	68,5-107	78	62	116,5	770	10
6950M AM NR BK XPlus™	61915 1	77	68,5-107	78	62	116,5	770	10
6950M AM NR BK XPlus™ OE	61916 8	77	68,5-107	78	62	116,5	770	10
6950M AM NR BK XPlus™ + 6KS/85 + ST 5950	95912 7	77	68,5-107	78	62	116,5	1560	1
6950M AM NR BK XPlus™ + 6KS/130 + ST 5950	61924 3	77	68,5-107	78	62	116,5	1920	1
6950M AM NR BK XPlus™ + 6KS/100 + ST 5950	95913 4	77	68,5-107	78	62	116,5	1750	1
FMU 6950	96201 1							1
Adapter plate 6950	99186 8						40	10



Security Tech Germany

6950M AM GRANIT XPLUS™

THE LOCK WITH UNIVERSAL FRAME FITTING

Thanks to the moveable mounting slots one lock will fit all common frame and tyre sizes



Made in Germany

PRO AMPARO 4750 X / XL

SECURITY LEVEL



FEATURES



SH



Mounting straps LH



VARIANTS



4750XL

TECHNICAL DATA

- 8.5 mm steel shackle
- The case, the shackle as well as supporting elements of the locking mechanism are made of specially hardened steel
- Extreme large aperture for extra wide tires
- Closing mechanism for easy attachment of accessory to the lock body
- The R (key retaining) version holds the key when the lock is open, the NR (non key retaining) version allows taking the key out of the cylinder

TECHNOLOGY



TEST SEALS



1) 35482 2) Only for "R" version

Ref. No.	EAN 4003318	a	b	c	d	e	Weight g	Box Qty
4750X NR black PRO AMPARO	69349 6	89	115	82	68	119	860	12
4750X NR black OE	86734 7	89	115	82	68	119	860	12
4750X R black PRO AMPARO	69352 6	89	115	82	68	119	860	12
4750X R black OE	86735 4	89	115	82	68	119	860	12
4750XL NR black PRO AMPARO	69353 3	89	115	101	68	119	800	12
4750XL NR black OE	86736 1	89	115	101	68	119	800	12
4750XL R black PRO AMPARO	69354 0	89	115	101	68	119	800	12
4750XL R black OE	86737 8	89	115	101	68	119	800	12
Bracket SH	37552 1						56	6
Mounting straps LH adaptor	56240 2						48	1

PRO AMPARO 4750 S / SL

SECURITY LEVEL



FEATURES



SH



Mounting straps LH



VARIANTS



4750SL

TECHNICAL DATA

- 8.5 mm shackle
- The shackle, the housing and the locking mechanism's load-bearing parts are manufactured from specially hardened steel
- Accessories can easily be fitted to the locking mechanism on the lock housing
- In the R version, the key remains in the cylinder when the lock is opened; in the NR version, it can be pulled out

TECHNOLOGY



TEST SEALS



1) 34358 2) Only for "R" version

Ref. No.	EAN 4003318	a	b	c	d	e	Weight g	Box Qty
4750S NR black PRO AMPARO	89676 7	75	100	70	56	106	652	1
4750S NR black OE	82611 5	75	100	70	56	106	700	16
4750S R black PRO AMPARO	89677 4	75	100	70	56	106	760	12
4750S R black OE	82612 2	75	100	70	56	106	760	16
4750SL NR black PRO AMPARO	89678 1	75	100	86	56	106	740	1
4750SL NR black OE	83573 5	75	100	86	56	106	740	16
4750SL R black PRO AMPARO	89679 8	75	100	86	56	106	740	12
4750SL R black OE	83574 2	75	100	86	56	106	740	16
Bracket SH	37552 1						56	6
Mounting straps LH adaptor	56240 2						48	1

4650 X / XL

FEATURES



SH



Mounting straps LH

SECURITY LEVEL



VARIANTS



4650XL



TECHNICAL DATA

- 8.5 mm steel shackle
- The case, the shackle as well as supporting elements of the locking mechanism are made of specially hardened steel
- Extreme large aperture for extra wide tires
- Closing mechanism for easy attachment of accessory to the lock body
- The R (key retaining) version holds the key when the lock is open, the NR (non key retaining) version allows taking the key out of the cylinder

TECHNOLOGY



TEST SEALS



Ref. No.	EAN	a	b	c	d	e	Weight g	Box Qty
	4003318							
4650X NR black OE	86730 9	94	115	82	72	121	720	14
4650X R black OE	86731 6	94	115	82	72	121	720	14
4650XL R black OE	86733 0	94	115	101	72	121	720	1
4650XL NR black OE	86732 3	94	115	101	72	121	720	14
Bracket SH	37552 1						56	6
Mounting straps LH adaptor	56240 2						48	1

4650 S / SL

FEATURES



SH



Mounting straps LH

SECURITY LEVEL



VARIANTS



4650SL



TECHNICAL DATA

- 8.5 mm shackle
- The shackle, the housing and the locking mechanism's load-bearing parts are manufactured from specially hardened steel
- Accessories can easily be fitted to the locking mechanism on the lock housing
- In the R version, the key remains in the cylinder when the lock is opened; in the NR version, it can be pulled out

TECHNOLOGY



TEST SEALS



Ref. No.	EAN	a	b	c	d	e	Weight g	Box Qty
	4003318							
4650S NR black OE	82609 2	80	100	70	60	108,4	660	20
4650S R black OE	82610 8	80	100	70	60	108,4	660	20
4650SL NR black OE	83575 9	80	100	86	60	108,4	640	20
4650SL R black OE	83576 6	80	100	86	60	108,4	640	20
Bracket SH	37552 1						56	6
Mounting straps LH adaptor	56240 2						48	1

PRO TECTIC™ 4960

FEATURES



SH



Mounting straps LH

SECURITY LEVEL



VARIANTS



4960 + 6KS/85 + ST5850



TECHNICAL DATA

- 8.5 mm thick locking shackle
- The shackle, the case as well as supporting elements of the locking mechanism are made of specially hardened steel
- Accessories can easily be fitted to the locking mechanism on the lock housing
- The R (key retaining) version holds the key when the lock is open, the NR (non key retaining) version allows taking the key out of the cylinder

TECHNOLOGY



Ref. No.	EAN 4003318	a	b	c	d	e	Weight g	Box Qty
4960 NR black	11260 7	76	96	69	57	107,9	520	6
4960 NR black OE	11270 6	76	96	69	57	107,9	520	18
	11263 8	76	96	69	57	107,9	1346	4
Bracket SH	37552 1						56	6
Mounting straps LH adaptor	56240 2						48	1

TECTIC™ 496

FEATURES



SH



Mounting straps LH

SECURITY LEVEL



TECHNICAL DATA

- 8.5 mm thick locking shackle
- The shackle, the case as well as supporting elements of the locking mechanism are made of specially hardened steel
- The R (key retaining) version holds the key when the lock is open, the NR (non key retaining) version allows taking the key out of the cylinder

TECHNOLOGY



Ref. No.	EAN 4003318	a	b	c	d	e	Weight g	Box Qty
496 NR black	11258 4	78	96	69	59	110	450	6
496 NR black OE	11269 0	78	96	69	59	110	450	24
496 R black OE	19457 3	78	96	69	59	110	450	24
Bracket SH	37552 1						56	6
Mounting straps LH adaptor	56240 2						48	1

ACH 2.0 ADAPTOR CHAIN

FEATURES



ST5850





ST5950



TECHNICAL DATA

- 6 and 8 mm square chain made of hardened steel
- Separate locking of the shackle is not necessary
- Various connection options
- Suitable for all ABUS frame locks and the Alarmbox 2.0
- Special coating on the loop ring protects the bike's paintwork from being damaged

Ref. No.	EAN 4003318	 mm	 cm	Weight g	Box Qty
ACH 2.0 6KS/85 black	95369 9	6	85	760	6
ACH 2.0 6KS/85 black + ST5950	95371 2	6	85	840	6
ACH 2.0 6KS/100 black	95360 6	6	100	860	6
ACH 2.0 6KS/100 black + ST5950	95363 7	6	100	1130	6
ACH 2.0 6KS/130 black	95366 8	6	130	1140	6
ACH 2.0 8KS/85 black	95375 0	8	85	1190	1
ACH 2.0 8KS/85 black + ST5950	95376 7	8	85	1270	1
ACH 2.0 8KS/100 black	95373 6	8	100	1400	1
ST 5850/5650/4960	48647 0			100	1
ST 5950 2.0	87510 6				1

ACL ADAPTOR CABLE

FEATURES





ST5850



TECHNICAL DATA

- 12 mm thick, high-quality steel cable
- Opens up a lot of opportunities for locking the bicycle on to a fixed object

Ref. No.	EAN 4003318	 mm	 cm	Weight g	Box Qty
ACL 12/100 black	18243 3	12	100	416	6
ST 5850/5650/4960	48647 0			100	1

IVYTEX ADAPTOR CHAIN

FEATURES



ST5950



VARIANTS





crossing grey

TECHNICAL DATA

- Adapter chain with IvyTex coating
- Square profile chain made of our own hardened steel alloy
- Durable cover made of synthetic IvyTex fibre offers resistance to saw attacks
- Hydrophobic IvyTex cover repels dirt and moisture
- 6 and 8 mm square chain made of hardened steel
- Fabric coating on the loop ring to protect against damage to the paintwork
- With frame locks, there is no need to separately lock the shackle
- Various options for connecting to fixed objects or linking multiple bicycles
- Suitable for ABUS frame locks and Alarmbox 2.0

TECHNOLOGY



Ref. No.	EAN 4003318	 mm	 cm	Weight g	Box Qty
ACH IVY 6KS/85 black	68457 9	6	85	760	6
ACH IVY 6KS/85 crossing grey	68456 2	6	85	760	6
ACH IVY 6KS/100 black	68460 9	6	100	860	6
ACH IVY 6KS/100 black + ST5950	69055 6	6	100	1064	6
ACH IVY 6KS/100 crossing grey	68459 3	6	100	860	6
ACH IVY 6KS/130 black	68463 0	6	130	1140	6
ACH IVY 6KS/130 crossing grey	68462 3	6	130	1140	6
ACH IVY 8KS/100 black	68466 1	8	100	1400	4
ACH IVY 8KS/100 crossing grey	68465 4	8	100	1400	4
ST 5950 2.0	87510 6				1

SERVICE PRICELIST

BATTERY LOCKS

Accel Group		Bosch	
96518	BLO ACC IT3 T82 Service	96687	BLO BOS RT2 Xplus Service
96691	BLO ACC IT3 Xplus Service	96297	BLO BOS UNI T82 Service
Bafang		Brose	
96306	BLO BAF 15,7 T82 Service	96669	BLO BRO IT1 LC T83 Service
Bike Fun		Cube	
96514	BLO BFI IT1 T82 Service	96677	BLO CUB IT1.B3 XPLUS Service
Bosch		96679	BLO CUB IT2 XPLUS Service
96515	BLO BOS AX1 T82 Service	96678	BLO CUB IT2.B3 XPLUS Service
96303	BLO BOS IT2.1 T82 Service	Cycle Union	
96521	BLO BOS DT2 PLUS Service	96682	BLO CYU IT1 XPLUS Service
96281	BLO BOS DT2 T82 Service	Darfon	
96502	BLO BOS DT2 XL T82 Service	96300	BLO DAF UNI LC T83 Service
96675	BLO BOS DT2 Xplus Service	96513	BLO DAF UNI T82 Service
96516	BLO BOS DT3 T82 Service	96692	BLO DAF UNI T83 Service
96517	BLO BOS DT3 T82 XL Service	Fazua	
96671	BLO BOS DT3 T83 Service	96574	BLO FAZ IT1 PLUS Service
96685	BLO BOS DT3 XPLUS 2X Service	96690	BLO FAZ IT2 Xplus Service
96684	BLO BOS DT3 XPLUS Service	Fit Biketec	
96686	BLO BOS DT3 XPlus XL Service	96681	BLO FIT IT1 Xplus Service
96673	BLO BOS IT2.1 Xplus Service	Giant	
96301	BLO BOS IT3 T82 Service	96504	BLO GIA IT1 F T82 Service
96672	BLO BOS IT3 T83 Service	96948	BLO GIA IT1 M T82 Service
96563	BLO BOS RT2 PLUS Service	96952	BLO GIA IT1 M XPLUS Service

Panasonic

96299 BLO PAN DT1 T82 Service

96570 BLO PAN IT1 PLUS Service

96674 BLO PAN IT1 XPLUS Service

Pexco

96577 BLO PEX IT2 PLUS Service

96565 BLO PEX IT3 PLUS Service

98414 BLO PEX IT3 XPLUS Service

Phylion

96307 BLO PHY 11,3 T82 Service

Scott

96680 BLO SCO IT2 auf IT2.1 Service

Shimano

96572 BLO SHI DT1 PLUS Service

96575 BLO SHI IT2 PLUS Service

96507 BLO SHI IT2 T82 ASY Service

96676 BLO SHI IT2 XPLUS Service

96289 BLO SHI RT1 T82 Service

Specialized

96573 BLO SPE IT2 PLUS Service

96670 BLO SPE IT3 T83 Service

96683 BLO SPE IT3 Xplus Service

Trek

96509 BLO TRE IT1 T82 Service

96984 BLO TRE IT1 PLUS Service

ZEG

96491 BLO ZEG IT1 T82 Service

96571 BLO ZEG IT3 PLUS Service

96576 BLO ZEG IT5 PLUS Service

96990 BLO ZEG IT4 XPLUS Service

98420 BLO ZEG IT5 XPLUS Service

Winora

96566 BLO+BRA WIN IT1 PLUS Service

96567 BLO+BRA WIN IT2 PLUS Service

IT: Intube

DT: Downtube

RT: Racktube

* These products will be delivered
without individual packaging

SPECIAL SECURITY



CHAIN CLAW 10



black

Page 108

ALARMBOX 2.0



black

Page 109

ALARMBOX RC



black

Page 109

WCH90



black

Page 110

GRANIT™ WBA 100



black

Page 111

GRANIT™ WBA 75



black

Page 111

WBA 65



black

Page 112

WBA 60



black

Page 113

WA 50



black

Page 113

SPORTFLEX 2504



black

Page 114

COMBIFLEX™



black

Page 114



neon

Page 114



midnight blue

Page 114



black + CHR

Page 114

COMBIFLEX™ TRAVELGUARD



black

Page 115



yellow

Page 115



red

Page 115

COMBIFLEX™ ADVENTURE



black

Page 115

COMBILLOOP 205



black

Page 116

CHAIN 6 KS LOOP



black

Page 116

COBRA™



black

Page 117

1850



black

Page 117

**FIRESTOP
AFS625**



Page 118

PS 88



Page 118

**KEYGARAGE™
SMART 797**



Page 119

**KEYGARAGE™
SMART 787**



Page 119

**KEYGARAGE™
787 BIG LED**



Page 120

**KEYGARAGE™
787 BIG**



Page 120

**KEYGARAGE™
787 LED**



Page 121

**KEYGARAGE™
787**



Page 121

**KEYGARAGE™
797 LED**



Page 122

**KEYGARAGE™
797**



Page 122

**KEYGARAGE™
767**



Page 123

ABUS TOUCH™ 57



silber

Page 123

145



schwarz

Page 124



gelb

Page 124



orange

Page 124



rot

Page 124



lila

Page 124



blau

Page 124



grün

Page 124



silber

Page 124



titanium

Page 124

64 TITALIUM™



Page 125

70 & 70IB



70

Page 126



70IB

Page 126

**DISKUS®
24IB**



Page 126

**DISKUS®
20**



Page 127

147TSA



Page 127

CHAIN CLAW 10

SECURITY LEVEL



TECHNICAL DATA

- 7 mm thick and 10 cm long square chain
- Rotating joints and a 55mm diameter engagement point for the cuffs provide maximum flexibility
- The chain as well as parts of the housing and clamps are made of specially hardened steel
- Opening code can be set individually

TECHNOLOGY



Ref. No.	EAN 4003318	 mm	 cm	Weight g	Box Qty
Chain Claw 10 black	95934 9	7	10	1070	1

ALARMBOX 2.0



VERSIONS



Alarmbox 2.0 black
+ 6KS/100

Alarmbox 2.0 black
+ ACL 12/100

Ref. No.	EAN 4003318	Weight g	Box Qty
Alarmbox 2.0 black	61482 8	430	12
Alarmbox 2.0 black + ACH 6KS/100	61488 0	1270	6
Alarmbox 2.0 black + ACL 12/100	61489 7	720	6

TECHNICAL DATA

- Alarm function with min. 100 dB for 15 seconds, followed by reactivation
- 3D Position Detection - alarm system that detects vibrations and the smallest movements in all three dimensions and triggers the alarm
- Smart alarm – the Alarmbox only emits a small warning beep in the event of minor and brief vibrations, e.g. if a football bounces nearby
- CR2 batteries included
- Mounting option on almost all round geometries
- Connection option for ABUS adapter chains and cables

TECHNOLOGY



ALARMBOX RC

FEATURES



RC



TECHNICAL DATA

- Alarmbox with remote control
- Alarm function with min. 100 dB for 15 seconds, followed by reactivation
- 3D position detection - detects vibrations and the smallest of movements in all three dimensions and triggers an alarm
- Smart alarm – the Alarmbox only emits a small warning beep in the event of minor and brief vibrations, e.g. if a football bounces nearby
- Convenient arming and disarming by remote control
- CR2 battery included (Alarmbox) / CR2032 battery included (remote control)
- Mounting option on almost all round geometries
- Very lightweight and therefore ideal for use in sports and outdoors
- Various connection options such as cable ties, double-sided adhesive tape, Velcro, etc.

TECHNOLOGY



Ref. No.	EAN 4003318	Weight g	Box Qty
Alarmbox RC SingleSet black	61487 3	82	12
Alarmbox RC TwinSet black	69058 7	164	12
Alarmbox RC Box only	69059 4	68	12
RC Remote Control Alarmbox black	69060 0	16	12

WCH90

SECURITY LEVEL



FEATURES



VERSIONS



WCH90 + ACH 9KS/130



WCH90 + ACH 9KS/130

TECHNICAL DATA

- Wall anchor with integrated chain
- Hardened steel housing high attack resistance
- The wall anchor is firmly anchored in the wall with special high security plugs and thus offers an extremely high level of theft protection
- The mounting plugs are included in the scope of delivery
- Only suitable for wall mounting
- The chain and the housing are made of specially hardened steel
- Textile coating to protect against paint damage
- The chains are available in different lengths
- ABUS XPlus cylinder for the greatest protection against manipulation, such as picking

TECHNOLOGY



TEST SEALS



Ref. No.	EAN	⊕	●	Weight g	Box Qty
WCH90 + ACH 9KS/110	4003318 69061 7	9	110	3580	3
WCH90 + ACH 9KS/110 Twin Chain	69063 1	9	110	6620	2
WCH90 + ACH 9KS/130	69062 4	9	130	3960	1

WBA100 GRANIT™

FEATURES



SECURITY LEVEL



Security Level
Motorbike

TECHNICAL DATA

- 16 mm thick shackle made of hardened special steel for maximum attack resistance
- Can be wall or floor mounted

TEST SEALS



Ref. No.	EAN 4003318	mm	mm	mm	mm	mm	Weight g	Box Qty
WBA100 GRANIT™	27161 8	160	165	16	65	77	1880	1

WBA75 GRANIT™

FEATURES



SECURITY LEVEL



TECHNICAL DATA

- 14 mm thick shackle made of hardened special steel for maximum resistance
- Incl. mounting accessories

TEST SEALS



Ref. No.	EAN 4003318	mm	mm	mm	mm	mm	Weight g	Box Qty
WBA75	78606 8	135	98	14	57	65	850	1

WBA65





★
NEW

TECHNICAL DATA

- 10 mm thick shackle
- Holder for the rear wheel
- Simple installation without dowels

SECURITY LEVEL



Ref. No.	EAN	 mm	 mm	 mm	 mm	 mm	Weight g	Box Qty
WBA65 B/SB + Bike Holder	97167 9	118	80				1094	1



WBA60

FEATURES



TECHNICAL DATA





- 10 mm thick shackle made of hardened special steel for maximum attack resistance
- Incl. mounting accessories

SECURITY LEVEL



TEST SEALS



Ref. No.	EAN	 mm	 mm	 mm	 mm	 mm	Weight g	Box Qty
WBA60	82211 7	118	80	10	52	55	450	1

WA50

FEATURES



TECHNICAL DATA

- Strong wall anchor made of hardened steel
- Incl. mounting material

SECURITY LEVEL



Ref. No.	EAN	 mm	 mm	 mm	 mm	 mm	Weight g	Box Qty
WA50	04294 2	80	110		38	38	786	1

SPORTFLEX 2504





TECHNICAL DATA

- Very lightweight and space-saving cable lock for mounting under the bottle holder
- Mounting by means of two screws included in the scope of delivery at the attachment points on the frame tube of the bicycle
- Low profile of 20 mm enables mounting under an existing bottle holder
- Self-retracting cable
- Opening code can be set individually
- Ideal for protection against thievery and opportunistic theft

TECHNOLOGY



Ref. No.	EAN 4003318	 mm	 cm	Weight g	Box Qty
2504/90	69054 9	2,4	90	100	1

COMBIFLEX™



TECHNICAL DATA

- Self-retracting cable
- Opening code can be set and changed by the user
- Attractive pocket format fits comfortably in any pocket
- Extendible steel cable

TECHNOLOGY



VERSIONS





neon



midnight blue



black + CHR

Ref. No.	EAN 4003318	 mm	 cm	Weight g	Box Qty
StopOver 65 black	95454 2	1,2	65	46	12
StopOver 65 neon	95458 0	1,2	65	46	12
StopOver 65 midnight blue	95459 7	1,2	65	46	12
Break 85 black	95455 9	1,5	85	58	12
Break 85 neon	95460 3	1,5	85	58	12
Break 85 midnight blue	95461 0	1,5	85	58	12
Rest 105 black	95456 6	2,4	105	85	12
Rest 105 black + CHR	95484 9	2,4	105	96	12
Trip 125 black	95457 3	3	125	128	12

COMBIFLEX™ TRAVELGUARD



TECHNICAL DATA

- Cable protection with extra solid steel core
- Users can set and change the 3-digit code themselves
- Cable lock with releasable locking mechanism
- Small and lightweight, fits well in trouser or jersey pocket

TECHNOLOGY





VERSIONS



black



yellow

Ref. No.	EAN 4003318	 mm	 cm	Weight g	Box Qty
TravelGuard black	95468 9	4	45	80	32
TravelGuard yellow	95601 0	4	45	80	32
TravelGuard red	95600 3	4	45	80	32

COMBIFLEX™ ADVENTURE



TECHNICAL DATA

- Compact cable lock with retractable cable
- Users can set and change the 3-digit code themselves
- Attractive pocket format fits comfortably in any pocket
- 4 mm thick and 75 cm long steel cable

TECHNOLOGY



Ref. No.	EAN 4003318	 mm	 cm	Weight g	Box Qty
Combiflex™ Adventure black	95465 8	4	75	90	1

COMBILoop 205



TECHNICAL DATA

- 5 mm thick steel cable
- Synthetic coating to prevent damage to the bicycle's paintwork
- Automatic locking at insertion of the locking bolt
- Individually settable code

TECHNOLOGY



SECURITY LEVEL



Ref. No.	EAN 4003318	 mm	 cm	Weight g	Box Qty
205/200 black	52523 0	5	200	180	12



CHAIN 6KS LOOP



TECHNICAL DATA

- 6 mm thick square chain made of hardened steel
- Diameter of the loop rings: 30 mm and 50 mm
- A textile sleeve around the chain and a plastic coating of the 50 mm ring protect against damage to the paintwork
- Available in two lengths: 100 cm and 140 cm





Ref. No.	EAN 4003318	 mm	 cm	Weight g	Box Qty
Chain 6KS100 Loop	97023 8	6	100	860	6
Chain 6KS140 Loop	97024 5	6	140	1220	1



TECHNICAL DATA

- High quality steel cable with two loop ends
- Synthetic coating to prevent damage to the bicycle's paintwork

Ref. No.	EAN 4003318	 mm	 cm	Weight g	Box Qty
Cobra™ 5/75 black	37106 6	5	75	75	100
Cobra™ 8/200 black	25718 6	8	200	280	1
Cobra™ 8/250 black	27390 2	8	250	395	16
Cobra™ 10/140 black	37107 3	10	140	310	30
Cobra™ 10/200 black	11167 9	10	200	400	1
Cobra™ 10/220 black	37108 0	10	220	420	24
Cobra™ 10/300 black	59930 9	10	300	560	21
Cobra™ 10/500 black	20780 8	10	500	850	1
Cobra™ 10/1000 black	20781 5	10	1000	1580	1
Cobra™ 12/120 black	25719 3	12	120	380	1
Cobra™ 12/180 black	27391 9	12	180	490	15

1850



TECHNICAL DATA

- High quality steel cable with two loop ends
- Synthetic coating to prevent damage to the bicycle's paintwork

Ref. No.	EAN 4003318	 mm	 cm	Weight g	Box Qty
1850/185	12752 6	8	185	280	18

AFS625



TECHNICAL DATA

- 625 ml highly effective foam extinguishing agent
- Easy to use – just like a conventional spray can
- Spraying range (max. distance between source of fire and user) up to 4 m
- Spray time approx. 25 seconds
- Weight: approx. 900 g gross
- Suitable for fighting incipient fires of fire classes A, B and F
- Fire class 5A: solid and non-melting substances
- Fire class 21B: liquid and melting substances
- Fire class 15F: cooking fats and cooking oils
- Also for use with electrical systems of up to 1000 V (distance of at least 1 m)

ACCESSORIES



Ref. No.	EAN 4003318	Weight	Box Qty
AFS625	85727 0	847	6
Bracket AFS625/FLS580	56249 5	81	1

PS88



TECHNICAL DATA

- Free from chlorine, fluorine (CKW/FCKW), PCB, lead and other contaminants
- Non-greasy special lubricant spray
- Door cylinders, bicycle lock cylinders, padlock cylinders, car locks, tools, sports equipment, office machines

VERSIONS



Ref. No.	EAN 4003318	Weight g	Box Qty	Version
PS88 50ml D	00117 8	59	1	50 ml aerosol can
PS88 125ml D	07010 5	124	1	125 ml aerosol can
PS88 300ml D	84408 9	301	1	300 ml aerosol can
VK PS88 50ml D	08217 7	60	1	24 x 50 ml
VK PS88 125ml D	06952 9	124	1	12 x 125 ml
VK PS88 300ml D	84409 6	3900	1	12 x 300 ml

797 SMART BLUETOOTH®





TECHNOLOGY



TECHNICAL DATA

- Large, sturdy metal housing
- Illuminated electronic keypad for entering a 6-digit key code
- Manage and use the KeyGarage™ using the HomeTec Pro Bluetooth app
- Generate and send individual access tickets or a 6-digit code for multiple users
- View the log access history and current users
- Capacity for up to 20 keys, 3 car keys or 30 plastic cards
- Integrated key hooks for hanging up keys/key fobs
- Automatic locking
- Battery compartment for 2 x AA batteries, accessible from the outside
- For safely storing keys or small valuable objects for authorised persons
- Fast and easy access for groups of people that change frequently (e.g. workers, service, holiday guests, vehicle rental, multi-family homes, care services)
- Access option of generating and sharing a key code or of sending an electronic access ticket through the HomeTec Pro Bluetooth app
- Mounting with shackle for flexible and temporary use in indoor and protected outdoor areas (e.g. on doorknobs, railings or handles)
- Store whole key fobs thanks to the large compartment inside

Ref. No.	EAN 4003318	 mm	 mm	 mm	Weight g	Box Qty
797 SMART-BT with shackle	63825 1	82,5	63	179	888	1

787 SMART BLUETOOTH®





TECHNOLOGY



TECHNICAL DATA

- Large, sturdy metal housing
- Illuminated electronic keypad for entering a 6-digit key code
- Manage and use the KeyGarage™ using the HomeTec Pro Bluetooth app
- Generate and send individual access tickets or a 6-digit code for multiple users
- View the log access history and current users
- Capacity for up to 20 keys, 3 car keys or 30 plastic cards
- Integrated key hooks for hanging up keys/key fobs
- Automatic locking
- Battery compartment for 2 x AA batteries, accessible from the outside
- For safely storing keys or small valuable objects for authorised persons
- Fast and easy access for groups of people that change frequently (e.g. workers, service, holiday guests, vehicle rental, multi-family homes, care services)
- Access option of generating and sharing a key code or of sending an electronic access ticket through the HomeTec Pro Bluetooth app
- For wall mounting indoors and in protected outdoor areas
- Store whole key fobs thanks to the large compartment inside

Ref. No.	EAN 4003318	 mm	 mm	 mm	Weight g	Box Qty
787 SMART-BT wall mounting	63824 4	82,5	63	120	883	1

787 BIG LED KEYGARAGE™





TECHNOLOGY



TECHNICAL DATA

- Solid metal housing
- Locking cover made of zinc die-cast
- 4-digit individually settable code
- Illuminated dials for a better legibility in dark conditions
- LEDs light up ca. 30 seconds
- Customary coin cell battery (CR2032) can be easily replaced, durability of battery when used 1x per day approximately 2 years
- Protective cover with sliding mechanism
- For wall mounting with screws
- Can hold up to 20 keys or 14 code cards (787 LED) or up to 30 keys or 50 code cards (787 BIG LED)
- Easily removable clip-in hooks guarantee consumer's comfort
- Outer dimensions of housing: 84 x 120 x 42 (787 LED) / 84 x 120 x 62 (787 BIG LED)
- Ideal protected storage of keys and other valuables for authorised persons
- Quick and easy access for frequently changing groups of persons (craftsmen, service, holiday guests, apartment buildings, car rentals)
- Defining access by setting and passing on the code
- For wall mounting indoors and in protected outdoor areas

Ref. No.	EAN 4003318	 mm	 mm	 mm	Weight g	Box Qty
787 BIG LED wall mounting	83856 9	84	62	120	721	1

787 BIG KEYGARAGE™





TECHNOLOGY



TECHNICAL DATA

- Very large solid metal housing and extra large storage compartment
- Locking cover made from zinc die-cast
- Individually resettable code (4-digit)
- Protective cover with sliding mechanism
- For wall mounting with screws
- Holds up to 30 cards or 50 keys
- Easily removable clip-in hooks guarantee consumer's comfort
- Flat inner mechanism makes a larger storage space possible
- Outer dimensions of housing: 84 x 120 x 62
- Ideal protected storage of keys and other valuables for authorised persons
- Quick and easy access for frequently changing groups of persons (craftsmen, service, holiday guests, apartment buildings, car rentals)
- Defining access by setting and passing on the code
- For wall fixing indoors and in protected outdoor areas
- Storage of a complete bunch of key now possible because of larger space and removable hook

Ref. No.	EAN 4003318	 mm	 mm	 mm	Weight g	Box Qty
787 BIG wall mounting	08492 8	83,5	62	120	841	1

787 LED KEYGARAGE™





TECHNOLOGY



TECHNICAL DATA

- Solid metal housing
- Locking cover made of zinc die-cast
- 4-digit individually settable code
- Illuminated dials for a better legibility in dark conditions
- LEDs light up ca. 30 seconds
- Customary coin cell battery (CR2032) can be easily replaced, durability of battery when used 1x per day approximately 2 years
- Protective cover with sliding mechanism
- For wall mounting with screws
- Can hold up to 20 keys or 14 code cards (787 LED) or up to 30 keys or 50 code cards (787 BIG LED)
- Easily removable clip-in hooks guarantee consumer's comfort
- Outer dimensions of housing: 84 x 120 x 42 (787 LED) / 84 x 120 x 62 (787 BIG LED)
- Ideal protected storage of keys and other valuables for authorised persons
- Quick and easy access for frequently changing groups of persons (craftsmen, service, holiday guests, apartment buildings, car rentals)
- Defining access by setting and passing on the code
- For wall mounting indoors and in protected outdoor areas

Ref. No.	EAN 4003318	 mm	 mm	 mm	Weight g	Box Qty
787 LED wall mounting	83854 5	84	42	120	698	1

787 KEYGARAGE™





TECHNOLOGY



TECHNICAL DATA

- Solid metal housing
- Locking cover made of zinc die-cast
- 4-digit individually settable code
- Protective cover with sliding mechanism
- For wall mounting with screws
- Can hold up to 20 keys or 14 code cards
- Outer dimensions of housing: 80 x 120 x 45
- Easily removable clip-in hooks guarantee consumer's comfort
- Ideal protected storage of keys and other valuables for authorised persons
- Quick and easy access for frequently changing groups of persons (craftsmen, service, holiday guests, apartment buildings, car rentals)
- Defining access by setting and passing on the code
- For wall mounting indoors and in protected outdoor areas

Ref. No.	EAN 4003318	 mm	 mm	 mm	Weight g	Box Qty
787 wall mounting	46331 0	80	45	120	690	1

797 LED KEYGARAGE™



FEATURES





Adapter

TECHNOLOGY



TECHNICAL DATA

- Solid metal housing
- Locking cover made of zinc die-cast
- 4-digit individually settable code 4-digit
- Illuminated dials for a better legibility in dark conditions
- LEDs light up ca. 30 seconds
- Customary coin cell battery (CR2032) can be easily replaced, durability of battery when used 1x per day approximately 2 years
- Protective cover with sliding mechanism
- Fixing with shackle, e.g. on a door knob of gates and doors
- Can hold up to 20 keys or 14 code cards
- Outer dimensions of housing: 84 x 119 x 44
- Housing and shackle plastic coated (protects door from scratching)
- Ideal protected storage of keys and other valuables for authorised persons
- Quick and easy access for frequently changing groups of persons (craftsmen, service, holiday guests, apartment buildings, car rentals)
- Defining access by setting and passing on the code
- Fixing with shackle, e.g. on a door knob of gates and doors

Ref. No.	EAN 4003318	 mm	 mm	 mm	Weight g	Box Qty
797 LED with shackle	83855 2	84	44	120	779	1
Adapter KeyGarage™ 777 + 797	56321 8	70	74	63	114	1

797 KEYGARAGE™



FEATURES





Adapter

TECHNOLOGY



TECHNICAL DATA

- Solid metal housing
- Locking cover made of zinc die-cast
- 4-digit individually settable code
- Protective cover with sliding mechanism
- Fixing with shackle, e.g. on a door knob of gates and doors
- Can hold up to 20 keys or 14 code cards
- Outer dimensions of housing: 85 x 120 x 45
- Housing and shackle plastic coated (protects door from scratching)
- Ideal protected storage of keys and other valuables for authorised persons
- Quick and easy access for frequently changing groups of persons (craftsmen, service, holiday guests, apartment buildings, car rentals)
- Defining access by setting and passing on the code
- Fixing with shackle, e.g. on a door knob of gates and doors

Ref. No.	EAN 4003318	 mm	 mm	 mm	Weight g	Box Qty
797 with shackle	46330 3	85	45	180	767	1
Adapter KeyGarage™ 777 + 797	56321 8	70	74	63	114	1

767 KEYGARAGE™





TECHNICAL DATA

- Solid metal housing
- Locking cover made from zinc die-cast
- Code up to 10 digits individually resettable (the sequence of the code is irrelevant)
- Code needs to be entered in order to close the locking cover
- Plastic cover to protect against dust, dirt, etc.
- For wall fixing with screws
- Holds up to 17 cards or 20 keys
- Outer dimensions of housing: 84 x 119 x 47
- Ideal protected storage of keys and other valuables for authorised persons
- Quick and easy access for frequently changing groups of persons (craftsmen, service, holiday guests, apartment buildings, car rentals)
- Defining access by setting and passing on the code
- For wall fixing indoors and in protected outdoor areas

TECHNOLOGY









Ref. No.	EAN 4003318	 mm	 mm	 mm	Weight g	Box Qty
767 wall mounting	53507 9	80	45	120	657	1

ABUS TOUCH™ 57



TECHNICAL DATA

- Lock body made of coated zinc die cast
- Hardened Nano Protect™ shackle
- CR2 battery
- Capacitive sensor with minutiae detection
- 20 fingerprints can be stored
- Double ball locking
- Automatic locking
- Spring-loaded shackle for automatic opening
- IP certification IP66 & IP68
- For securing medium-value items when there is a medium risk of theft
- Use in clean areas with good fingerprint recognition
- Suitable for indoor and outdoor use

Ref. No.	EAN 4003318	 mm	 mm	 mm	 mm	 mm	 mm	Weight g	Box Qty
57/45	62575 6	45	20	30	6,5	23	95	361	1
57/50	62581 7	50	24	36	8	23	103	390	1



TECHNICAL DATA

- Solid aluminium lock body with anodized coating – corrosion resistant
- Spring loaded shackle for a better setting of the opening code
- 145/20 and 145/30: Individually resettable 3-digit code
- 145/40: Individually resettable 4-digit code
- Handy operation without key, low weight
- High value of recognition by intensive colours
- 145/20 and 145/30: To secure valuables/goods of lesser value or at a low risk of theft
- 145/40: To secure valuables/goods of medium value or at an average risk of theft
- E.g. to secure luggage, lockers in schools and sports centres, cash boxes, jewel cases, cupboards, tool boxes, switchboards, etc.

VERSIONS



145/20 yellow



145/20 orange



145/20 red



145/20 violet



145/20 blue









145/20 green



145/20 silver



145/20 titanium

Ref. No.	EAN 4003318	 mm	 mm	 mm	 mm	 mm	 mm	Weight g	Box Qty
145/20 yellow B/DFNLIESP	46572 7	22,5	9	22	3	13,5	52,5	30	12
145/20 orange B/DFNLIESP	46570 3	22,5	9	22	3	13,5	52,5	23	12
145/20 red B/DFNLIESP	46569 7	22,5	9	22	3	13,5	52,5	30	12
145/20 purple B/DFNLIESP	46573 4	22,5	9	22	3	13,5	52,5	23	12
145/20 blue B/DFNLIESP	46568 0	22,5	9	22	3	13,5	52,5	23	6
145/20 green B/DFNLIESP	46571 0	22,5	9	22	3	13,5	52,5	23	12
145/20 silver B/DFNLIESP	46574 1	22,5	9	22	3	13,5	52,5	23	12
145/20 titanium B/DFNLIESP	46576 5	22,5	9	22	3	13,5	52,5	23	12
145/20 black B/DFNLIESP	34599 9	22,5	9	22	3	13,5	52,5	25	12
145/30 black B/DFNLIESP	34601 9	31,5	14	25	5	15,5	65	55	12
145/30 orange B/DFNLIESP	46579 6	31,5	14	25	5	15,5	65	60	12
145/30 red B/DFNLIESP	46578 9	31,5	14	25	5	15,5	65	52	12
145/30 purple B/DFNLIESP	46582 6	31,5	14	25	5	15,5	65	52	12
145/30 blue B/DFNLIESP	46577 2	31,5	14	25	5	15,5	65	60	12
145/30 green B/DFNLIESP	46580 2	31,5	14	25	5	15,5	65	52	12
145/30 silver B/DFNLIESP	46583 3	31,5	14	25	5	15,5	65	50	12
145/30 titanium B/DFNLIESP	46585 7	31,5	14	25	5	15,5	65	60	12
145/30 yellow B/DFNLIESP	46581 9	31,5	14	25	5	15,5	65	53	12
145/40 yellow B/EFSP	49535 9	41,5	21,5	26	6	17,5	77	103	6
145/40 orange B/EFSP	49527 4	41,5	21,5	26	6	17,5	77	103	6
145/40 red B/EFSP	48829 0	41,5	21,5	26	6	17,5	77	105	6
145/40 purple B/EFSP	49539 7	41,5	21,5	26	6	17,5	77	105	6
145/40 blue B/EFSP	49523 6	41,5	21,5	26	6	17,5	77	105	6
145/40 green B/EFSP	49531 1	41,5	21,5	26	6	17,5	77	105	6
145/40 silver B/EFSP	49543 4	41,5	21,5	26	6	17,5	77	105	6
145/40 titanium B/EFSP	49551 9	41,5	21,5	26	6	17,5	77	105	6
145/40 black B/EFSP	34605 7	41,5	21,5	26	6	17,5	77	110	6

64 TITALIUM™



TECHNICAL DATA

- Solid lock body made from TITALIUM™ special aluminium
- Hardened steel shackle with NANO PROTECT™ coating for extreme corrosion resistance
- 64TI/50HB60-150: Removable and adjustable shackle from 60 mm to 150 mm
- Paracentric key profile for increased protection against manipulation
- Double bolted shackle
- Chrome-plated cylinder plug for additional corrosion protection
- Tulip-shaped key head
- Security for items/goods of medium value or where there is an average risk of theft
- For securing e.g. chains, doors, gates, cupboards, lockers, tool boxes, cellar windows or sheds

VERSIONS



64TI/20 B/EFSP



64TI/25 B/EFSP



64TI/30 B/EFSP



64TI/30HB60 B/EFSP



64TI/35 B/EFSP









64TI/40HB40 B/EFSP



64TI/40HB63 B/EFSP



64TI/45 B/EFSP

Ref. No.	EAN 4003318	 mm	 mm	 mm	 mm	 mm	 mm	Weight g	Box Qty
64TI/20 B/EFSP	56361 4	20	9,5	11,5	3,5	10,5	34	23	6
64TI/25 B/EFSP	56362 1	24,5	13	13,5	4	12	42	31	6
64TI/30 B/EFSP	56363 8	30	16	17	5	13	50	54	6
64TI/30HB60 B/EFSP	56374 4	30	16	60	5	13	93	80	6
64TI/35 B/EFSP	56364 5	35	19	20	5,5	14	54	67	6
64TI/40 B/EFSP	55015 7	40	22	23	6	15	62	88	6
64TI/40HB40 B/EFSP	55021 8	40	22	40	6	15	79	96	6
64TI/40HB63 B/EFSP	56377 5	40	22	63	6	15	102	107	6
64TI/45 B/EFSP	56365 2	45	25	24	7	15	68	110	6
64TI/50 B/EFSP	56366 9	50	28	29	8	17	77	159	6
64TI/50HB80 B/EFSP	56382 9	50	28	80	8	17	128	200	6
64TI/50HB60-150 B/EFSP	88884 7	50	28	60-150	8	17	77	281	4
64TI/60 B/EFSP	56383 6	60	34	35	10	19	91	234	4

70 EXPEDITION



TECHNICAL DATA

- Solid lock body made from brass
- Shackle made from hardened steel with plastic sleeve
- Sealed lock body with special protective cap and drainage channels to protect the locking mechanism from water and dirt
- Shock-absorbing plastic casing protects sensitive surfaces
- Double bolted
- Precision pin cylinder
- Paracentric key profile for increased protection against manipulation
- Inner components made from rust-free materials
- Self-locking: lock without the key by pushing down the shackle
- Security for items/goods of medium value or where there is an average risk of theft
- For securing chains, doors, gates, cupboards, lockers, tool boxes, cellar windows, sheds, switch boxes, etc.
- Also suitable for outdoor use

FEATURES

VERSIONS



70/45HB63









70IB/45



70IB/50



70IB/45HB63

Ref. No.	EAN 4003318	 mm	 mm	 mm	 mm	 mm	 mm	Weight g	Box Qty
70/45 B/EFSP	35148 8	49	20	24	8	27,5	74	179	6
70/45HB63 B/EFSP	32384 3	49	20	63	8	27,5	112	210	6
70IB/45 B/EFSP	32182 5	49	20	24	8	27,5	74	178	6
70IB/45HB63 B/EFSP	35835 7	49	20	63	8	27,5	112	200	6
70IB/50 B/EFSP	42732 9	55	23,5	27,5	9	31	81,5	233	6

24IB DISKUS®









TECHNICAL DATA

- Lock body, inner parts and shackle made solely from stainless steel for extreme resistance to corrosion
- Cylinder cover – maximum protection against dirt and water spray (60 mm and 70 mm only)
- Nickel-plated cylinder for enhanced weather protection
- Original Diskus® design: 360° protection
- Diskus® Deep-Welding Technology – the best in break-in protection
- Precision pin cylinder
- Key retaining: locking only with the key (key cannot be removed while the lock remains open)
- Made in Germany
- For the protection of larger assets and objects with a high risk of theft
- Ideal for severe weather conditions (e.g., in sea and port areas, for securing vehicles and boats in outdoor use)
- For securing trucks, doors, gates, barns, cellars, cupboards, etc.

FEATURES



Ref. No.	EAN 4003318	 mm	 mm	 mm	 mm	 mm	 mm	Weight g	Box Qty
24IB/50 B/EFSP	35041 2	51	13	8	6,5	25,5	50	129	6
24IB/60 B/EFSP	35043 6	60	17	13	8	26	60	195	6
24IB/70 B/EFSP	35044 3	70	20	17	10	31	70	291	6

20 DISKUS®









FEATURES



TECHNICAL DATA

- Stainless steel - outside and inside
- Additional protection against sawing
- Shackle made from high quality stainless steel
- ABUS-Plus disc cylinder: highest protection against manipulation, extremely high number of key differs
- Cylinder cover – maximum protection against dirt and water spray
- Sophisticated Diskus® welded seam for highest break resistance
- Original Diskus® design: 360° protection
- Key retaining: key is needed for locking (lock retains key until locked)
- SZP: comes with security card to protect against unauthorized key duplicates
- Made in Germany
- 2 keys
- To secure valuables/goods of great value or at a very high risk of theft
- To secure e.g. warehouses, industrial sites, factory gates, containers and lorries
- Ideally used with ABUS Diskus® Hasp 140: virtually impossible to attack shackle

Ref. No.	EAN 4003318	 mm	 mm	 mm	 mm	 mm	 mm	Weight g	Box Qty
20/70 kd.	08854 4	70	20	17	10	30,5	70	306	6
20/80 kd.	08798 1	80	25	18	11	35,5	81	416	3
20/70 B/EFSP	32164 1	70	20	17	10	30,5	70	306	3
20/80 B/EFSP	32165 8	80	25	18	11	35,5	81	415	3

147TSA









TECHNOLOGY



TECHNICAL DATA

- Lock body made from plastic
- Shackle diameter 3 mm
- Individually resettable 3-digit code
- Visible red indicator at shackle: lock was opened by TSA. To reset red indicator open lock and turn shackle by 360°
- Para repor o indicador para uma nova viagem, rodar o arco 360°
- To secure valuables/goods of lower value or at a low risk of theft
- Suitable e.g. to secure luggage
- Ideal for journeys to the USA: the luggage can be opened/relocked by the US security authorities without damaging the lock

Ref. No.	EAN 4003318	 mm	 mm	 mm	 mm	 mm	 mm	Weight g	Box Qty
147TSA/30 B	53093 7	33	13	20	3	14	60	32	12

BRACKETS AND BAGS



**BRACKET
SH B**



black

Page 132

**BRACKET
USKF**



black

Page 133

**BRACKET
EAZY KFT™**



black

Page 133

**BRACKET USH 540 /
470 / 460 / 440A**



black

Page 133

**BRACKET
GH 50**



black

Page 134

**BRACKET
UGH 02**



black

Page 134

SHACKLE CLAMP



black

Page 134

**BRACKET
SADDLEFIX SH SF**



black

Page 135

**BRACKET
SH 6500A SMARTX™**



black

Page 135

**BRACKET
SH 6500K BORDO™**



black

Page 135

**BRACKET
SH 6500 BORDO™ BIG**



black

Page 136

**BRACKET
SH 6000 BORDO™**



black

Page 136

**BRACKET
SH FL**



black

Page 136

**BRACKET
SH 6000 BORDO™ BIG**



black

Page 137

**BRACKET
SH 5700 BORDO™**



black

Page 137

**BRACKET SH 5700
UGRIP BORDO™ BIG**



black

Page 137

**BRACKET
SH 6055 BORDO™ LITE**



black

Page 138

**BRACKET
SR 6055 BORDO™**



black

Page 138

**BRACKET
ST 6000 BORDO™**



black

Page 138

**BRACKET ST 6000
BORDO™ BIG**



black

Page 139

**BRACKET ST 5700
UGRIP BORDO™**



black

Page 139

**BRACKET
IVERA RBU**



black

Page 139

**BRACKET
QUICK STORE QST**



black

Page 140

**BRACKET
SADDLEFIX QST**



black

Page 140

**CHAIN BAG
ST 2012**



black

Page 140

**SAC
ST 5850 / 5650 / 4960**



black

Page 141

**BRACKET
SNAP CAGE**



black

Page 141

**BRACKET
SCLL**



black

Page 141

**BRACKET SELLE ROYAL
(5C, 5K, 6C, 6K)**



black

Page 142

**BRACKET
FIDLOCK FL**



black

Page 142

**BRACKET
FIDLOCK TEXFL**



black

Page 142

**BRACKET
TEXKF MINI**



black

Page 143

**BRACKET
QUICKSNAP RBU**



black

Page 143

**BRACKET
QUICKSNAP**



black

Page 143

**BRACKET
KF**



black

Page 144

**URB (UNIVERSAL
FRAME BRACKET)**



black

Page 144

MOUNTING STRAPS

LH



black

Page 144

**ORYDE
ST 2250**



black

Page 145

**ORYDE
ST 2200**



black

Page 145

**ORYDE
ST 2085**



black

Page 145

**ORYDE
ST 2100**



black

Page 146

**BASICO
ST 5200**



black

Page 146

ST 5950 2.0



black

Page 146

CARRIER SH B



TECHNICAL DATA

- Universal shackle lock holder for many ABUS U-locks
- The holder is suitable for U-locks with a 14mm square as well as a 16mm round shackle
- Allows the lock to be transported to different places on the bike
- The holder allows for vertical or horizontal attachment to the frame
- Suitable for U-locks 640, 540, 470, 460
- Fast and intuitive handling
- Suitable for frame diameters from 20-55 mm

Ref. No.	EAN	Weight	Carrier	Box
	4003318	g		Qty
Bracket SH B	67899 8	150	for 640, 540, 470, 460	1

BRACKET USKF



TECHNICAL DATA

- Transport of U-shackle locks
- Mounting on round frames with a diameter of 18-70 mm
- Plastic bracket with rubber inlays for best mounting
- Comfortable one-hand-operation
- Easy and quick mounting

Ref. No.	EAN 4003318	Weight g	Carrier	Box Qty
Bracket USKF	86143 7	65	for 64/46/47/770A/540/460/470/640	1

BRACKET EAZY KF™



TECHNICAL DATA

- Transport of U-shackle locks
- Mounting on round frames with a diameter of 28 - 36 mm
- Screws in two lengths included
- Plastic bracket for mounting with rubber inlays for best hold
- Index marks on the bracket to simplify subsequent mountings
- Comfortable one-hand-operation
- Very quick mounting
- Patented design

Ref. No.	EAN 4003318	Version	Weight g	Carrier	Box Qty
Bracket EaZy KF™	45342 7		95	for 64/61/54/51/47/540/470	1
Shackle Clamp 11mm	45344 1	∅ 11 mm	22	for 61/64 EaZy KF	1
Shackle Clamp 12mm	45347 2	∅ 12 mm	24	for 47 EaZy KF/470	1
Shackle Clamp 13mm	45343 4	∅ 13 mm	26	for 540/770A	1
Shackle Clamp 13mm	45346 5	∅ 13 mm	28	for 51/501	1

BRACKET USH540 / 470 / 460 / 440A TEX



TECHNICAL DATA

- Transport of U-shackle locks
- Mounting on round frames with a diameter of 15 - 35 mm
- Plastic bracket for mounting
- Mounting within the frame or at the side possible

Ref. No.	EAN 4003318	Version	Weight g	Carrier	Box Qty
Bracket USH 540	18576 2		150	for 540	1
Bracket USH 460 / 470	18578 6		120	for 460 / 470 / 32	1
Bracket USH 440 Tex	87553 3		96	for 440A	1

BRACKET GH 50



TECHNICAL DATA

- Transport of round U-shackle locks with a diameter up to 17mm
- Mounting on the side of the rack
- Plastic bracket for mounting

Ref. No.	EAN	Version	Weight g	Carrier	Box Qty
Bracket GH 50	4003318 00904 4		196	for ABUS No. 64, 51, 47, 46, 470, 460, 32	1

BRACKET UGH 02



TECHNICAL DATA

- Transport of Steel-0-Flex and other locks
- Mounting on the rack stays with a diameter of 5 - 16.5 mm
- Universal solution for all common racks
- Simple and time saving mounting

Ref. No.	EAN	Version	Weight g	Carrier	Box Qty
Bracket UGH 02	4003318 26624 9		80	for 950, 970, 1000, 1025, 7200, 7220, 8200, 8220	1

SHACKLE CLAMP



TECHNICAL DATA

- Accessory for the transport in a TUBUS LOCC U-shackle lock carrier, TexKF Twin or RBKF Twin

Ref. No.	EAN	Version	Weight g	Carrier	Box Qty
Shackle Clamp 12mm	4003318 25604 2	∅ 12 mm	21	for 46, 47, 460, 470	1
Shackle Clamp	27348 3	∅ 13 mm	30	for 540	1

BRACKET SH SF SADDLEFIX



TECHNICAL DATA

- Universal adapter for space-saving attachment of various BORDO™ locks to saddle stays
- Your desired BORDO™ lock can be fixed to the adapter together with the corresponding bracket
- A rain cap is included in the scope of delivery: as splash and weather protection for your BORDO™ lock
- The holes on the adapter are analogous to those on a water bottle holder, so that this or the SportFlex lock could also be fixed to the adapter
- Screws are included in the scope of delivery
- Adapter for attachment to the saddle
- Suitable for brackets SH 5700, 6000 and 6500
- Practical rain cover and protection against dirt and moisture

Ref. No.	EAN 4003318	Version	Weight g	Carrier	Box Qty
Bracket SH SF	67866 0		121	for SH 5700C/80, SH 5700K/80, SH 6000C/90, SH 6000K/120, SH 6000K/90, SH 6500/85	3

BRACKET SH 6500A SMARTX



TECHNICAL DATA

- For easy transportation of the BORDO 6500A SmartX
- Simple mounting with fixing strap or Velcro strap
- Does not require much space, as the lock can be removed from the front
- Ideal for small frame geometries

Ref. No.	EAN 4003318	Version	Weight g	Carrier	Box Qty
Bracket SH 6500A SmartX™	63488 8		148	for 6500A/110	1

BRACKET SH 6500K BORDO™



TECHNICAL DATA

- Easy transport for BORDO 6500KA/90 and 6500K/90
- Simple and toolless mounting due to practical mounting strap
- The lock can be easily removed forwards
- Perfect for small framed bikes

Ref. No.	EAN 4003318	Version	Weight g	Carrier	Box Qty
Bracket SH 6500K/90	69051 8		195	for 6500KA/90, 6500K/90	3
Bracket SH 6500K/120	96279 0		230	for 6500K/120	1

BRACKET SH 6500 BORDO XPLUS™



TECHNICAL DATA

- Easy transport for BORDO™ 6500
- Simple and toolless mounting due to practical mounting straps
- The lock can be easily removed forwards
- Perfect for small framed bikes

Ref. No.	EAN 4003318	Version	Weight g	Carrier	Box Qty
Bracket SH 6500/85	61557 3		152	for 6500/85	3
Bracket SH 6500/110	61556 6		172	for 6500/110	3

BRACKET SH 6000 BORDO™



TECHNICAL DATA

- Easy transport for BORDO™ 6000, 6015 and 6100
- Simple and toolless mounting due to practical mounting straps
- The lock can be easily removed forwards
- Perfect for small framed bikes

Ref. No.	EAN 4003318	Version	Weight g	Carrier	Box Qty
Bracket SH 6000/90	61543 6		115	for 6000/90, 6000K/90, 6000KA/90, 6000C/90, 6000A/90, 6100/90	3

BRACKET SH ML- BORDO MOUNT



TECHNICAL DATA

- For easy transportation of the BORDO 6000K/90, 6000C/90 or the 6000KA/90
- Simple and super-fast magnetic attachment to the Fidlock TWIST bike base
- Does not require much space, as the lock can be removed from the front
- The BORDO 6000K/90 and 6000C/90 are also available individually without brackets

Ref. No.	EAN 4003318	Version	Weight g	Carrier	Box Qty
Bracket SHFL 6000/90	88886 1		160	for 6000/90, 6100/90, 6000A/90, 6000K/90, 6000C/90, 6000KA/90	3

BRACKET SH 6000 BORDO™ BIG



TECHNICAL DATA

- Easy transport for BORDO™ 6000 BIG
- Simple and toolless mounting due to practical clutching straps
- The lock can be easily removed forwards
- Perfect for small framed bikes

Ref. No.	EAN 4003318	Version	Weight g	Carrier	Box Qty
Bracket SH 6000/120	61564 1		132	for 6000/120, 6000K/120, 6000KA/120, 6000A/120	3

BRACKET SH 5700 BORDO



TECHNICAL DATA

- Easy transport for BORDO 5700K uGrip
- Simple and toolless mounting due to practical mounting straps
- The lock can be easily removed forwards
- Perfect for small framed bikes

Ref. No.	EAN 4003318	Version	Weight g	Carrier	Box Qty
Bracket SH 5700/80	61566 5		122	for 5700K/80 und 5700C/80	3

BRACKET SH 5700 UGRIP BORDO BIG



TECHNICAL DATA

- Easy transport for BORDO 5700 uGrip BIG
- Simple and toolless mounting due to practical mounting straps
- The lock can be easily removed forwards
- Perfect for small framed bikes

Ref. No.	EAN 4003318	Version	Weight g	Carrier	Box Qty
Bracket SH 5700K/100	61571 9		122	for 5700K/100	3

BRACKET SH 6055 BORDO™ LITE



TECHNICAL DATA

- Easy transport for BORDO™ 6055 Lite
- Simple and toolless mounting due to practical mounting straps
- The lock can be easily removed forwards
- Perfect for small framed bikes

Ref. No.	EAN 4003318	Version	Weight g	Carrier	Box Qty
Bracket SH 6055	61572 6		60	replacement bracket	3

BRACKET SH 6055 SELLE ROYAL



TECHNICAL DATA

- For easy transportation of the BORDO 6055 Lite and Lite Mini (both Key and Combo variants)
- Easy mounting under Selle Royal saddles
- Ideal for use on road bikes

Ref. No.	EAN 4003318	Version	Weight g	Carrier	Box Qty
Bracket SR 6055 Selle Royal	63151 1		64	for 6055K/60, 6055K/85, 6055C/60 and 6055C/85	3

BRACKET ST 6000 BORDO™



TECHNICAL DATA

- Flexible mounting with non-slip velcro straps or screws for the bottle holder device or bolts using the bottle cage fittings
- Easy transport thanks to practical holder

Ref. No.	EAN 4003318	Version	Weight g	Carrier	Box Qty
Bracket ST 6000/90 black	54297 8		125	for 6000K/90, 6000C/90	1

BRACKET ST 6000 BORDO™ BIG



TECHNICAL DATA

- Flexible mounting with non-slip velcro straps or screws for the bottle holder device or bolts using the bottle cage fittings
- Easy transport thanks to practical holder

Ref. No.	EAN 4003318	Version	Weight g	Carrier	Box Qty
Bracket ST 6000/120 black	55327 1		160	replacement bag	1

BRACKET ST 5700 UGRIP BORDO™



TECHNICAL DATA

- Transport bag with latching mechanism and comfortable one-hand-operation
- Flexible mounting with non-slip velcro straps or screws for the bottle holder device or bolts using the bottle cage fittings
- Easy transport thanks to practical holder

Ref. No.	EAN 4003318	Version	Weight g	Carrier	Box Qty
Bracket ST 5700 uGrip BORDO	11284 3		103	for 5700K/80	1

BRACKET IVERA RBU



TECHNICAL DATA

- Transport of chain, cable and Steel-o-flex locks of the Ivera series
- For mounting on round and non-round frame profiles with a diameter of 15 - 45 mm or for practical mounting on the seat clamp
- Easy mounting with a metal sleeve or LL bracket

Ref. No.	EAN 4003318	Version	Weight g	Carrier	Box Qty
Bracket IVERA RBU	58497 8		125	for 7200, 7210, 7220 Ivera	1

QUICKSTORE QST HOLDER



TECHNICAL DATA

- For transporting chain locks securely with no rattling
- For ABUS chain locks with 6 mm thickness and 85-110 cm length
- Easy mounting with screws on the bottle holder or by means of practical fixing strap carrier
- Can be combined with the SaddleFix holder (SF QST) for mounting under the saddle
- Stowage and transport option for chain locks
- Adequado para cadeados de corrente com até 6 mm de espessura
- Para proteger a corrente contra intempéries

Ref. No.	EAN	Version	Weight g	Carrier	Box Qty
Bracket QST	4003318 61493 4		260	for Catena 6806K	6

SF QST HOLDER



TECHNICAL DATA

- Adapter for attaching a lock holder under the saddle
- Suitable for the QST QuickStore holder
- Para facilitar o transporte de cadeados de corrente de 6-7 mm de espessura
- For attaching the QuickStore holder (QST) under the saddle

Ref. No.	EAN	Version	Weight g	Carrier	Box Qty
Bracket SF QST	4003318 95585 3		65	Bracket QST Quickstore	24

CHAIN BAG ST 2012

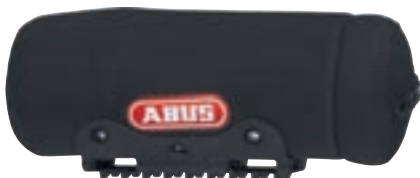

TECHNICAL DATA

- Bag designed for the protected transport of lock-chain-combinations
- Flexible mounting with non-slip velcro straps or screws at the bottle holder device
- 2 mm strong neoprene to keep the content cool or warm
- Strengthened inner-plate for easy mounting

Ref. No.	EAN	Version	Weight g	Box Qty
ST 2012 Chain Bag	4003318 58496 1	transportation bag: 0.6 l	188	1

BAG ST 5850/5650/4960



TECHNICAL DATA

- Bag for protected transport of frame locks and accessories
- Convenient attachment to the luggage carrier

Ref. No.	EAN	Version	Weight g	Box Qty
ST 5850/5650/4960	4003318 48647 0	Transport bag 160 mm / 250 mm / 50 mm	100	1

BRACKET SNAP CAGE



TECHNICAL DATA

- Transport of Steel-0-Flex, cable- and coil cable locks
- Enables transporting the lock on the seat post, on the frame and on the rack stays
- With a diameter of 15 - 55 mm
- Simple mounting without tools

Ref. No.	EAN	Version	Weight g	Carrier	Box Qty
Bracket Snap Cage MU 6K	4003318 20079 3		40	for 6415K, 6512K, 6615K	12
Bracket Snap Cage MU 4K/5K	20080 9		40	for 4508K, 5510K, 5412K	12
Bracket Snap Cage MU 4C/5C	20111 0		40	for 4508C, 5412C, 5510C	12
Bracket Snap Cage MU 6C	20113 4		40	for 6415C, 6512C, 6615C	12

BRACKET SCLL



TECHNICAL DATA

- Transport of cable, coil cable and Steel-0-Flex locks
- Mounting on all common seat post bolts (diameter 5-8 mm)
- Easy mounting

Ref. No.	EAN	Version	Weight g	Carrier	Box Qty
Bracket SCLL 6C	4003318 87983 8		47	for 6415C, 6512C, 6615C	12
Bracket SCLL 4K/5K	87982 1		47	for 4508K, 510K, 5412K	12
Bracket SCLL 4C/5C	87981 4		47	for 4508C, 5412C, 5510C	12
Bracket SCLL 6K	87984 5		47	for 6415K, 6512K, 6615K	12

SH SELLE ROYAL BRACKET (FOR 6512, 5510, 6412 AND 5410)



TECHNICAL DATA

- Easy to attach and use
- Compatible with Selle Royal ICS

Ref. No.	EAN 4003318	Version	Weight g	Carrier	Box Qty
Bracket 5K Selle Royal	63484 0		45	for 4508K, 5510K, 5412K	1
Bracket 5C Selle Royal	63485 7		45	for 4508C, 5412C, 5510C	1
Bracket 6K Selle Royal	63486 4		45	for 6415K, 6512K, 6615K	1
Bracket 6C Selle Royal	63487 1		45	for 6415C, 6512C, 6615C	1

BRACKET FL



TECHNICAL DATA

- Exclusively for the transport of the Phantom 8960, 8950 and 8940
- For the effortless magnetic mounting on and handy removal from the bracket
- Mounting on all common seat post bolts (diameter 5-8 mm)
- Easy mounting

Ref. No.	EAN 4003318	Version	Weight g	Carrier	Box Qty
Bracket FL	39729 5		61	for Phantom 8960, 8950, 8940	1

BRACKET TEXFL



TECHNICAL DATA

- Exclusively for the transport of the Phantom 8960, 8950 and 8940
- For the effortless magnetic mounting on and handy removal from the bracket
- Mounting on round and non-round frame profiles with a diameter of 21 - 80 mm
- Flexible textile sleeve for mounting

Ref. No.	EAN 4003318	Version	Weight g	Carrier	Box Qty
Bracket TexFL	39730 1		77	for Phantom 8960, 8950, 8940	1

BRACKET TEXKF MINI



TECHNICAL DATA

- Transport mostly cable, coil cable and Steel-0-Flex locks
- Mounting on round and non-round frame profiles with a diameter of 21 - 80 mm
- Flexible textile sleeve for mounting
- Mounting within the frame or at the side possible
- Simple and time saving mounting

Ref. No.	EAN	Version	Weight g	Carrier	Box Qty
Bracket TexKF Mini	4003318 23265 7		70	for 640, 1460, 8950, 1450, 8940	1

BRACKET QUICKSNAP RBU



TECHNICAL DATA

- Transport of cable and Steel-0-Flex locks
- Mounting on round and non-round frame profiles with a diameter of 15 - 45 mm
- Flexible metal sleeve for mounting
- Mounting within the frame or at the side possible
- Simple and time saving mounting

Ref. No.	EAN	Version	Weight g	Carrier	Box Qty
Bracket QuickSnap RBU	4003318 31487 2		40	for 860, 870	6

BRACKET QUICKSNAP



TECHNICAL DATA

- Transport of cable and Steel-0-Flex locks
- Mounting on all common seat post bolts (diameter 5 - 8 mm)
- Simple mounting

Ref. No.	EAN	Version	Weight g	Carrier	Box Qty
Bracket QuickSnap	4003318 31488 9		46	for 860, 870	1

BRACKET KF



TECHNICAL DATA

- Transport of cable, coil cable and Steel-0-Flex locks
- Mounting on all common seat post bolts (diameter 5 - 8 mm)
- Simple mounting

Ref. No.	EAN	Version	Weight g	Carrier	Box Qty
Bracket KF	4003318 12433 4		42	for 896, 895, 894, 885, 875, 1350, 1355, 1340, 1440, 1450, 1460	6

URB (UNIVERSAL FRAME BRACKET)



TECHNICAL DATA

- Accessory for transporting locks with the LL carrier
- Enables transporting the lock on the seat post or on the frame (diameter 25 - 35 mm)

Ref. No.	EAN	Version	Weight g	Carrier	Box Qty
Bracket URB	4003318 23312 8	Ø 25-35 mm	30	for locks with LL holder device	12

MOUNTING STRAP LH ADAPTOR



TECHNICAL DATA

- Mounting of frame locks to the bike frame

Ref. No.	EAN	Version	Weight g	Carrier	Box Qty
Mounting strap LH adaptor	4003318 56240 2		48	5950, 5850, 5750, 5650, 565, 52	1

ORYDE ST 2250



TECHNICAL DATA

- 1.8 litres stowing capacity
- Water-repellent and robust materials 420D and Scotch Rip 58
- Stable shape
- Reflective applications
- Practical interior design with key hook
- Very ample main compartment
- Frame bag for every day and leisure use

Ref. No.	EAN	Capacity l	Width mm	Height mm	Depth mm	Version	Box Qty
ST 2250	4003318 08469 0	1.8	235	195	50	Velco Straps	1

ORYDE ST 2200



TECHNICAL DATA

- 1.2 litres stowing capacity
- Water-repellent and robust materials 420D and Scotch Rip 58
- Stable shape
- Reflective applications
- Practical interior design with key hook
- Very ample main compartment
- Frame bag for every day and leisure use

Ref. No.	EAN	Capacity l	Width mm	Height mm	Depth mm	Version	Box Qty
ST 2200	4003318 08470 6	1.2	255	100	50	Velco Straps	1

ORYDE ST 2085



TECHNICAL DATA

- 0.7 litre stowing capacity
- Water-repellent and robust materials 420D and Scotch Rip 58
- Stable shape
- Reflective applications
- Practical interior design with key hook
- Particularly simple to fill due to ABUS Easy Flap System
- Includes rain cover with reflective logo
- Saddle bag for every day, sport and leisure use

Ref. No.	EAN	Capacity l	Width mm	Height mm	Depth mm	Version	Box Qty
ST 2085 KF	4003318 08479 9	0.7	75	70	145	KLICKfix® Saddle Bracket	1

ORYDE ST 2100



TECHNICAL DATA

- 1.2 litre stowing capacity
- Water-repellent and robust materials 420D and Scotch Rip 58
- Stable shape
- Reflective applications
- Practical interior design with key hook
- Expandable pullout to increase stowing capacity
- Saddle bag for every day, sport and leisure use

ArticleName	EAN 4003318	Capacity l	Width mm	Height mm	Depth mm	Version	Box Qty
ST 2100 KF	08472 0	1.2	80	95	150	KLICKfix®	6

BASICO ST 5200



TECHNICAL DATA

- 1.2 litres stowing capacity
- Water repellent and robust material
- Practical interior design
- Very ample main compartment
- Reflective applications
- Frame bag for every day and leisure use

ArticleName	EAN 4003318	Capacity l	Width mm	Height mm	Depth mm	Version	Box Qty
ST 5200	08482 9	1.2	255	110	65	Velcro straps	1

ST 5950 2.0



TECHNICAL DATA

- Saddle bag for every day, sport and leisure use

ArticleName	EAN 4003318	Capacity l	Width mm	Height mm	Depth mm	Version	Box Qty
ST 5950 2.0	87510 6	0,6	160	85	90	velcro straps	1



ABUS OEM

STRONG SERVICE PARTNER, RELIABLE SUPPLIER ABUS AS OEM PARTNER – YOUR FIRST CHOICE



In the bicycle market, the factors of success are added value, differentiation, flexibility, availability, fast service and high capacity. Suppliers that work with bicycle manufacturers have to meet the corresponding requirements. ABUS meets them.

As a globally experienced specialist in bicycle security, we offer you the best possible support and a high level of reliability. For years, ABUS has been a synonym for security, and has earned a leading position in the bicycle accessory market.

Quality „Made in Germany“ and „Just in time“ deliveries: concentrating on these core competences has made us an important partner for many bicycle manufacturers worldwide. We are also a strong partner on the OEM market, offering a wide selection of frame locks, integrated security solutions, and many individual products. Among others, we offer keyed alike locks and battery cylinders for e-bikes.

Allow us to take advantage of mutual synergy and implement it to our shared success!

Our OEM team looks forward to hearing from you at: oem@abus.de

We hope to continue our good cooperation with leading bicycle manufacturers!





CUSTOM SECURITY

Custom security solutions are not just a trend, but also a very convenient way for cyclists to secure their beloved bicycles. Take advantage of our more than 90 years of experience, and set yourself apart from the masses with a customized security solution.

ADVANCED

Bianchi
LIFE

BERGAMONT



CANYON

CORRATEC

CUBE FLYER HAIBIHE



HERCULES

Husqvarna
E-BICYCLES

KETTLER ALU-RAD

KTM
BIKE INDUSTRIES



ORBEA

RIESE & MÜLLER



SIMPLON



STEVENS
BIKES



TREK

URBAN ARROW

VELO@VILLE

ZEMO
zero emission mobility

ROAD



AIRBREAKER



performance red

Page 160



goldfish orange

Page 160



polar white matt

Page 160



moss green

Page 160



Movistar Team 23

Page 160



velvet black

Page 160



race grey

Page 160



polar white shiny

Page 160



gleam silver

Page 160



flip flop

Page 160



dark grey

Page 160



black gold

Page 160

GAMECHANGER TT



shiny white

Page 162



shiny black

Page 162



blaze red

Page 162



flip flop purple

Page 162



champagne gold

Page 162

GAMECHANGER TRI



blaze red

Page 164



shiny white

Page 164



shiny black

Page 164



flip flop purple

Page 164



champagne gold

Page 164

GAMECHANGER 2.0



shiny white

Page 166



velvet black

Page 166



titan

Page 166



race grey

Page 166



performance red

Page 166



flip flop purple

Page 166



goldfish orange

Page 166



gleam silver

Page 166



moss green

Page 166



polar white

Page 166



black gold

Page 166



velvet black

Page 166



shiny white

Page 166



performance red

Page 166



flip flop purple

Page 166

STORMCHASER ACE



velvet black

Page 168



race grey

Page 168



performance red

Page 168



flip flop purple

Page 168



polar white

Page 168

POWERDOME ACE



moss green

Page 170



race grey

Page 170



metallic copper

Page 170

POWERDOME



gleam silver

Page 172



polar white

Page 172



velvet black

Page 172



shiny black

Page 172



titan

Page 172



shiny white

Page 172



goldfish orange

Page 172



blaze red

Page 172



flip flop purple

Page 172



gleam silver

Page 172



polar white

Page 172



velvet black

Page 172



shiny black

Page 172



titan

Page 172



shiny white

Page 172



goldfish orange

Page 172



blaze red

Page 172



flip flop purple

Page 172

WINGBACK



flip flop purple

Page 174



velvet black

Page 174



titan

Page 174



race grey

Page 174



shiny white

Page 174



performance red

Page 174



goldfish orange

Page 174



gleam silver

Page 174



moss green

Page 174



polar white

Page 174

MACATOR



matt titan

Page 176



white silver

Page 176



velvet black

Page 176



titan

Page 176



steel blue

Page 176



signal yellow

Page 176



shiny rose

Page 176



race grey

Page 176



pearl white

Page 176



midnight blue

Page 176



gleam silver

Page 176



blaze red

Page 176



matt black

Page 176



matt blue

Page 176



velvet black

Page 176



signal yellow

Page 176



polar white

Page 176



pearl white

Page 176



shiny black

Page 176



SHOCKRAMBA

MADE IN ITALY

ABRIL





PRODUCT FEATURE MATRIX

AIRBREAKER

GAMECHANGER
2.0

STORMCHASER
ACE

POWERDOME

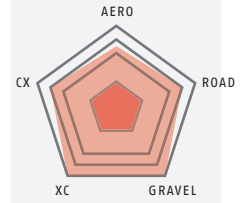
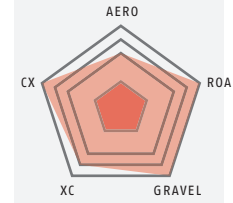
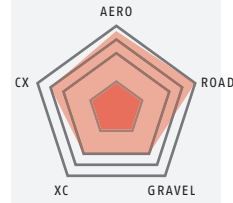
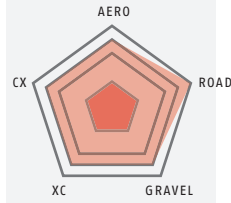

SHELLS	4	5	4	2
LOWER SHELL	✓	✓	✓	-
EYEWEAR PORT	✓	✓	✓	-
GRIDS	✓	✓	-	-

RETENTION SYSTEM	ZOOM	ZOOM PRO	ZOOM PRO	ZOOM ACE
PADDING	FLOATING	FLOATING PRO	FLOATING	FLOATING
STRAPS	FLOWSTRAPS	FLOWSTRAPS PRO	FLOWSTRAPS	FLOWSTRAPS
WEIGHT	200g	250g	220g	220g
BOX	SLIDER	SLIDER	EASY	EASY
PRODUCTION	ITALY	ITALY	ITALY	ITALY
VISOR / PEAK	-	-	-	-
ADD-ONS	-	Mips DUN	-	Mips
SIZES	S/M/L	S/M/L	S/M/L	S/M/L

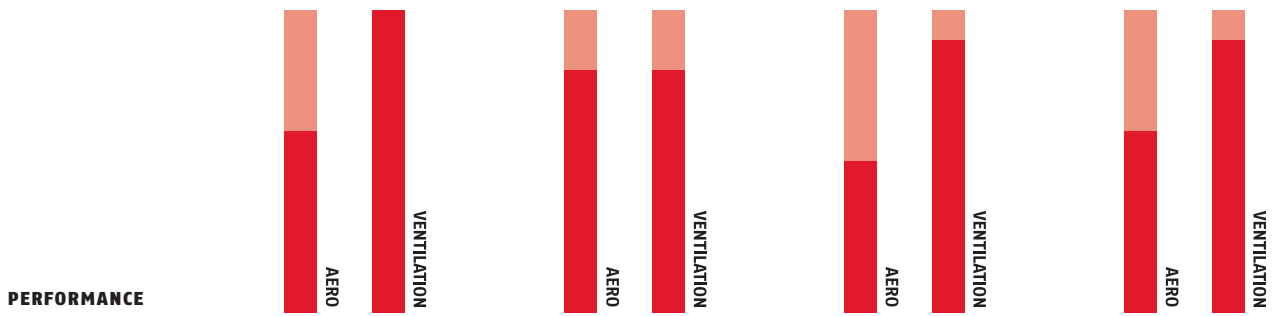

WINGBACK

MACATOR

GAMECHANGER
TT

GAMECHANGER
TRI

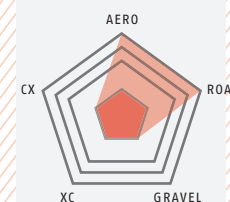
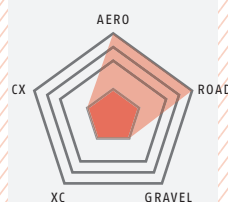
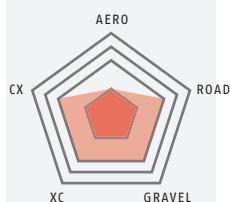
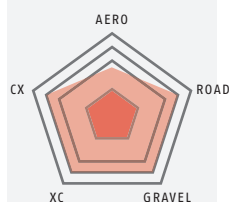

SHELLS	1,5	1	6	5
LOWER SHELL	-	-	✓	✓
EYEWEAR PORT	-	-	-	✓
GRIDS	-	-	-	-

RETENTION SYSTEM	ZOOM ACE	ZOOM ACE	ZOOM	ZOOM
PADDING	VELCRO	VELCRO	FLOATING	FLOATING
STRAPS	FLOWSTRAPS	DIVIDER	FLOWSTRAPS	FLOWSTRAPS
WEIGHT	240g	300g	390g	320g
BOX	EASY	SIMPLE	SLIDER	SLIDER
PRODUCTION	ITALY	CHINA	ITALY	ITALY
VISOR / PEAK	-	✓	✓	✓
ADD-ONS			-	-
SIZES	S/M/L	S/M/L	S/M/L	S/M/L

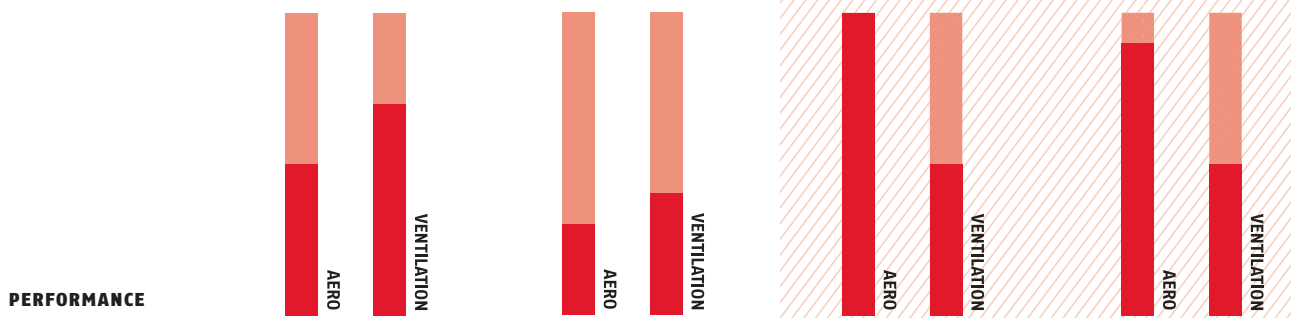

AIRBREAKER

VIEWS



performance red



performance red



FEATURES



Zoom Ace



Buckle



FlowStraps



Grid



EyewearPort

ACCESSOIRES

- ABUS Bag
- Helmet bag sportiv
- Race Cap

TECHNOLOGY



VERSIONS



goldfish orange

polar white matt

moss green

Movistar Team 23

velvet black

race grey

polar white shiny



gleam silver



flip flop



dark grey



black gold

Ref. No.	EAN 4003318	Colour	Finish	Weight g	Size	Head Size cm	Box Qty
Airbreaker	97973 6	performance red	shiny	200	S	51 - 55	1
Airbreaker	97974 3	performance red	shiny	210	M	52 - 58	1
Airbreaker	97975 0	performance red	shiny	230	L	59 - 61	1
Airbreaker	97976 7	goldfish orange	shiny	200	S	51 - 55	1
Airbreaker	97977 4	goldfish orange	shiny	210	M	52 - 58	1
Airbreaker	97978 1	goldfish orange	shiny	230	L	59 - 61	1
Airbreaker	97980 4	polar white	matt	200	S	51 - 55	1
Airbreaker	97981 1	polar white	matt	210	M	52 - 58	1
Airbreaker	97982 8	polar white	matt	230	L	59 - 61	1
Airbreaker	97983 5	moss green	shiny	200	S	51 - 55	1
Airbreaker	97984 2	moss green	shiny	210	M	52 - 58	1
Airbreaker	97985 9	moss green	shiny	230	L	59 - 61	1
Airbreaker	97986 6	Movistar Team 23	shiny	200	S	51 - 55	1
Airbreaker	97987 3	Movistar Team 23	shiny	210	M	52 - 58	1
Airbreaker	97988 0	Movistar Team 23	shiny	230	L	59 - 61	1
Airbreaker	81719 9	velvet black	matt	200	S	51 - 55	1
Airbreaker	81720 5	velvet black	matt	210	M	52 - 58	1
Airbreaker	81721 2	velvet black	matt	230	L	59 - 61	1
Airbreaker	40278 4	race grey	shiny	200	S	51 - 55	1
Airbreaker	40279 1	race grey	shiny	210	M	52 - 58	1
Airbreaker	40280 7	race grey	shiny	230	L	59 - 61	1
Airbreaker	81731 1	polar white	shiny	200	S	51 - 55	1
Airbreaker	81732 8	polar white	shiny	210	M	52 - 58	1
Airbreaker	81733 5	polar white	shiny	230	L	59 - 61	1
Airbreaker	81740 3	gleam silver	matt	200	S	51 - 55	1
Airbreaker	81741 0	gleam silver	matt	210	M	52 - 58	1
Airbreaker	81742 7	gleam silver	matt	230	L	59 - 61	1
Airbreaker	87512 0	flip flop purple	shiny	200	S	51 - 55	1
Airbreaker	87513 7	flip flop purple	shiny	210	M	52 - 58	1
Airbreaker	87514 4	flip flop purple	shiny	230	L	59 - 61	1
Airbreaker	86844 3	dark grey	shiny	200	S	51 - 55	1
Airbreaker	86845 0	dark grey	shiny	210	M	52 - 58	1
Airbreaker	86846 7	dark grey	shiny	230	L	59 - 61	1
Airbreaker	86829 0	black gold	matt	200	S	51 - 55	1
Airbreaker	86830 6	black gold	matt	210	M	52 - 58	1
Airbreaker	86831 3	black gold	matt	230	L	59 - 61	1



GAMECHANGER TT

VIEWS



shiny white



shiny white



FEATURES



Zoom Ace



Fidlock



FlowStraps



Magnetic glass

ACCESSOIRES

- Helmet bag sportiv

TECHNOLOGY



VERSIONS



shiny black



blaze red



flip flop purple



champagne gold

Ref. No.	EAN 4003318	Colour	Finish	Weight g	Size	Head Size cm	Box Qty
GameChanger TT	87885 5	shiny black	shiny	370	S	51 - 55	1
GameChanger TT	87886 2	shiny black	shiny	390	M	52 - 58	1
GameChanger TT	87887 9	shiny black	shiny	430	L	58 - 61	1
GameChanger TT	87888 6	shiny white	shiny	370	S	51 - 55	1
GameChanger TT	87889 3	shiny white	shiny	390	M	52 - 58	1
GameChanger TT	87890 9	shiny white	shiny	430	L	58 - 61	1
GameChanger TT	64177 0	blaze red	shiny	370	S	51 - 55	1
GameChanger TT	64178 7	blaze red	shiny	390	M	52 - 58	1
GameChanger TT	64180 0	blaze red	shiny	430	L	58 - 61	1
GameChanger TT	64182 4	flip flop purple	shiny	370	S	51 - 55	1
GameChanger TT	64185 5	flip flop purple	shiny	390	M	52 - 58	1
GameChanger TT	64186 2	flip flop purple	shiny	430	L	58 - 61	1
GameChanger TT	64174 9	champagne gold	shiny	370	S	51 - 55	1
GameChanger TT	64175 6	champagne gold	shiny	390	M	52 - 58	1
GameChanger TT	64176 3	champagne gold	shiny	430	L	58 - 61	1
Spare visor clear	67936 0	clear			S		1
Spare visor clear	67937 7	clear			M		1
Spare visor clear	67938 4	clear			L		1
Spare visor smoke	67939 1	smoke			S		1
Spare visor smoke	67940 7	smoke			M		1
Spare visor smoke	67941 4	smoke			L		1
Spare visor chrome	67942 1	chrome			S		1
Spare visor chrome	67943 8	chrome			M		1
Spare visor chrome	67944 5	chrome			L		1



GAMECHANGER TRI

VIEWS



blaze red



blaze red



FEATURES



Zoom Ace



Fidlock



FlowStraps

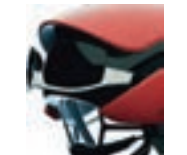

AirPort



Magnetic glass

ACCESSOIRES

- Helmet bag sportiv

TECHNOLOGY



VERSIONS



shiny white



shiny black



flip flop purple



champagne gold

Ref. No.	EAN 4003318	Colour	Finish	Weight g	Size	Head Size cm	Box Qty
GameChanger TRI	64275 3	shiny white	shiny	310	S	51 - 55	1
GameChanger TRI	64276 0	shiny white	shiny	320	M	52 - 58	1
GameChanger TRI	64278 4	shiny white	shiny	360	L	58 - 61	1
GameChanger TRI	64271 5	shiny black	shiny	310	S	51 - 55	1
GameChanger TRI	64272 2	shiny black	shiny	320	M	52 - 58	1
GameChanger TRI	64273 9	shiny black	shiny	360	L	58 - 61	1
GameChanger TRI	64268 5	flip flop purple	shiny	310	S	51 - 55	1
GameChanger TRI	64269 2	flip flop purple	shiny	320	M	52 - 58	1
GameChanger TRI	64270 8	flip flop purple	shiny	360	L	58 - 61	1
GameChanger TRI	64189 3	champagne gold	shiny	310	S	51 - 55	1
GameChanger TRI	64277 7	champagne gold	shiny	320	M	52 - 58	1
GameChanger TRI	64279 1	champagne gold	shiny	360	L	58 - 61	1
GameChanger TRI	64280 7	blaze red	shiny	310	S	51 - 55	1
GameChanger TRI	64281 4	blaze red	shiny	320	M	52 - 58	1
GameChanger TRI	64282 1	blaze red	shiny	360	L	58 - 61	1
Spare visor clear	67936 0	clear			S		1
Spare visor clear	67937 7	clear			M		1
Spare visor clear	67938 4	clear			L		1
Spare visor smoke	67939 1	smoke			S		1
Spare visor smoke	67940 7	smoke			M		1
Spare visor smoke	67941 4	smoke			L		1
Spare visor chrome	67942 1	chrome			S		1
Spare visor chrome	67943 8	chrome			M		1
Spare visor chrome	67944 5	chrome			L		1



GAMECHANGER 2.0

★
NEW

VIEWS



shiny white



shiny white



FEATURES



Zoom Pro



EyewearPort

ACCESSOIRES

- Helmet bag sportiv
- ABUS Bag
- Race Cap

TECHNOLOGY



VERSIONS



Ref. No.	EAN 4003318	Colour	Finish	Weight g	Size	Head Size cm	Box Qty
GameChanger 2.0	97996 5	velvet black	matt+shiny	260	S	51 - 55	1
GameChanger 2.0	97997 2	velvet black	matt+shiny	265	M	54 - 58	1
GameChanger 2.0	97998 9	velvet black	matt+shiny	275	L	57 - 61	1
GameChanger 2.0	97999 6	titan	shiny	260	S	51 - 55	1
GameChanger 2.0	98000 8	titan	shiny	265	M	54 - 58	1
GameChanger 2.0	98001 5	titan	shiny	275	L	57 - 61	1
GameChanger 2.0	98002 2	race grey	shiny	260	S	51 - 55	1
GameChanger 2.0	98003 9	race grey	shiny	265	M	54 - 58	1
GameChanger 2.0	98004 6	race grey	shiny	275	L	57 - 61	1
GameChanger 2.0	98005 3	shiny white	shiny	260	S	51 - 55	1
GameChanger 2.0	98006 0	shiny white	shiny	265	M	54 - 58	1
GameChanger 2.0	98007 7	shiny white	shiny	275	L	57 - 61	1
GameChanger 2.0	98008 4	performance red	shiny	260	S	51 - 55	1
GameChanger 2.0	98009 1	performance red	shiny	265	M	54 - 58	1
GameChanger 2.0	98010 7	performance red	shiny	275	L	57 - 61	1
GameChanger 2.0	98011 4	flip flop purple	shiny	260	S	51 - 55	1
GameChanger 2.0	98012 1	flip flop purple	shiny	265	M	54 - 58	1
GameChanger 2.0	98013 8	flip flop purple	shiny	275	L	57 - 61	1
GameChanger 2.0	98014 5	goldfish orange	shiny	260	S	51 - 55	1
GameChanger 2.0	98015 2	goldfish orange	shiny	265	M	54 - 58	1
GameChanger 2.0	98016 9	goldfish orange	shiny	275	L	57 - 61	1
GameChanger 2.0	98017 6	gleam silver	matt+shiny	260	S	51 - 55	1
GameChanger 2.0	98018 3	gleam silver	matt+shiny	265	M	54 - 58	1
GameChanger 2.0	98019 0	gleam silver	matt+shiny	275	L	57 - 61	1
GameChanger 2.0	98020 6	moss green	shiny	260	S	51 - 55	1
GameChanger 2.0	98021 3	moss green	shiny	265	M	54 - 58	1
GameChanger 2.0	98028 2	moss green	shiny	275	L	57 - 61	1
GameChanger 2.0	98022 0	polar white	matt+shiny	260	S	51 - 55	1
GameChanger 2.0	98023 7	polar white	matt+shiny	265	M	54 - 58	1
GameChanger 2.0	98024 4	polar white	matt+shiny	275	L	57 - 61	1
GameChanger 2.0	98025 1	black gold	matt+shiny	260	S	51 - 55	1
GameChanger 2.0	98026 8	black gold	matt+shiny	265	M	54 - 58	1
GameChanger 2.0	98027 5	black gold	matt+shiny	275	L	57 - 61	1
GameChanger 2.0 MIPS	98029 9	velvet black	matt+shiny	260	S	51 - 55	1
GameChanger 2.0 MIPS	98030 5	velvet black	matt+shiny	275	M	54 - 58	1
GameChanger 2.0 MIPS	98031 2	velvet black	matt+shiny	285	L	57 - 61	1
GameChanger 2.0 MIPS	98032 9	shiny white	shiny	260	S	51 - 55	1
GameChanger 2.0 MIPS	98033 6	shiny white	shiny	275	M	54 - 58	1
GameChanger 2.0 MIPS	98034 3	shiny white	shiny	285	L	57 - 61	1
GameChanger 2.0 MIPS	98035 0	performance red	shiny	260	S	51 - 55	1
GameChanger 2.0 MIPS	98036 7	performance red	shiny	275	M	54 - 58	1
GameChanger 2.0 MIPS	98037 4	performance red	shiny	285	L	57 - 61	1
GameChanger 2.0 MIPS	98038 1	flip flop purple	shiny	260	S	51 - 55	1
GameChanger 2.0 MIPS	98039 8	flip flop purple	shiny	275	M	54 - 58	1
GameChanger 2.0 MIPS	98040 4	flip flop purple	shiny	285	L	57 - 61	1



STORMCHASER ACE

VIEWS



velvet black



velvet black



FEATURES



Zoom Ace



FlowStraps



EyewearPort

ACCESSOIRES

- ABUS Bag
- Helmet bag sportif
- Race Cap

TECHNOLOGY



VERSIONS



race grey



performance red



flip flop purple



polar white

Ref. No.	EAN 4003318	Colour	Finish	Weight g	Size	Head Size cm	Box Qty
StormChaser ACE	98041 1	velvet black	matt	200	S	51 - 55	1
StormChaser ACE	98042 8	velvet black	matt	220	M	54 - 58	1
StormChaser ACE	98043 5	velvet black	matt	240	L	57 - 61	1
StormChaser ACE	98044 2	race grey	shiny	200	S	51 - 55	1
StormChaser ACE	98045 9	race grey	shiny	220	M	54 - 58	1
StormChaser ACE	98046 6	race grey	shiny	240	L	57 - 61	1
StormChaser ACE	98047 3	performance red	shiny	200	S	51 - 55	1
StormChaser ACE	98048 0	performance red	shiny	220	M	54 - 58	1
StormChaser ACE	98049 7	performance red	shiny	240	L	57 - 61	1
StormChaser ACE	98050 3	flip flop purple	shiny	200	S	51 - 55	1
StormChaser ACE	98051 0	flip flop purple	shiny	220	M	54 - 58	1
StormChaser ACE	98052 7	flip flop purple	shiny	240	L	57 - 61	1
StormChaser ACE	98053 4	polar white	matt	200	S	51 - 55	1
StormChaser ACE	98054 1	polar white	matt	220	M	54 - 58	1
StormChaser ACE	98055 8	polar white	matt	240	L	57 - 61	1



POWERDOME ACE

VIEWS



moss green



moss green



FEATURES



Zoom Ace



FlowStraps

ACCESSOIRES

- ABUS Bag
- Race Cap

TECHNOLOGY



VERSIONS



race grey



metallic copper

Ref. No.	EAN 4003318	Colour	Finish	Weight g	Size	Head Size cm	Box Qty
PowerDome ACE	91970 1	race grey	shiny	210	S	51 - 55	1
PowerDome ACE	91971 8	race grey	shiny	230	M	54 - 58	1
PowerDome ACE	91972 5	race grey	shiny	250	L	57 - 61	1
PowerDome ACE	91976 3	metallic copper	matt	210	S	51 - 55	1
PowerDome ACE	91977 0	metallic copper	matt	230	M	54 - 58	1
PowerDome ACE	91978 7	metallic copper	matt	250	L	57 - 61	1
PowerDome ACE	91973 2	moss green	shiny	210	S	51 - 55	1
PowerDome ACE	91974 9	moss green	shiny	230	M	54 - 58	1
PowerDome ACE	91975 6	moss green	shiny	250	L	57 - 61	1



POWERDOME

NEW

VIEWS



gleam silver



gleam silver



FEATURES



Zoom Ace



FlowStraps

ACCESSOIRES

- ABUS Bag
- Race Cap

TECHNOLOGY



VERSIONS



Ref. No.	EAN 4003318	Colour	Finish	Weight g	Size	Head Size cm	Box Qty
PowerDome	98243 9	polar white	matt	210	S	51 - 55	1
PowerDome	98244 6	polar white	matt	230	M	54 - 58	1
PowerDome	98246 0	polar white	matt	250	L	54 - 58	1
PowerDome	97989 7	gleam silver	matt+shiny	210	S	51 - 55	1
PowerDome	97990 3	gleam silver	matt+shiny	230	M	54 - 58	1
PowerDome	97991 0	gleam silver	matt+shiny	250	L	57 - 61	1
PowerDome	91920 6	velvet black	matt	210	S	51 - 55	1
PowerDome	91921 3	velvet black	matt	230	M	54 - 58	1
PowerDome	91922 0	velvet black	matt	250	L	57 - 61	1
PowerDome	91923 7	shiny black	shiny	210	S	51 - 55	1
PowerDome	91924 4	shiny black	shiny	230	M	54 - 58	1
PowerDome	91925 1	shiny black	shiny	250	L	57 - 61	1
PowerDome	91926 8	titan	shiny	210	S	51 - 55	1
PowerDome	91927 5	titan	shiny	230	M	54 - 58	1
PowerDome	91928 2	titan	shiny	250	L	57 - 61	1
PowerDome	91929 9	shiny white	shiny	210	S	51 - 55	1
PowerDome	91930 5	shiny white	shiny	230	M	54 - 58	1
PowerDome	91934 3	shiny white	shiny	250	L	57 - 61	1
PowerDome	91940 4	goldfish orange	shiny	210	S	51 - 55	1
PowerDome	91941 1	goldfish orange	shiny	230	M	54 - 58	1
PowerDome	91942 8	goldfish orange	shiny	250	L	57 - 61	1
PowerDome	91943 5	blaze red	shiny	210	S	51 - 55	1
PowerDome	91944 2	blaze red	shiny	230	M	54 - 58	1
PowerDome	91945 9	blaze red	shiny	250	L	57 - 61	1
PowerDome	91946 6	flip flop purple	shiny	210	S	51 - 55	1
PowerDome	91947 3	flip flop purple	shiny	230	M	54 - 58	1
PowerDome	91948 0	flip flop purple	shiny	250	L	57 - 61	1
PowerDome MIPS	97992 7	gleam silver	matt+shiny	240	S	51 - 55	1
PowerDome MIPS	97993 4	gleam silver	matt+shiny	260	M	54 - 58	1
PowerDome MIPS	97994 1	gleam silver	matt+shiny	280	L	57 - 61	1
PowerDome MIPS	98248 4	polar white	matt	240	S	51 - 55	1
PowerDome MIPS	98249 1	polar white	matt	260	M	51 - 55	1
PowerDome MIPS	98250 7	polar white	matt	280	L	51 - 55	1
PowerDome MIPS	91949 7	velvet black	matt	240	S	51 - 55	1
PowerDome MIPS	91950 3	velvet black	matt	260	M	54 - 58	1
PowerDome MIPS	91951 0	velvet black	matt	280	L	57 - 61	1
PowerDome MIPS	91952 7	shiny black	shiny	240	S	51 - 55	1
PowerDome MIPS	91953 4	shiny black	shiny	260	M	54 - 58	1
PowerDome MIPS	91954 1	shiny black	shiny	280	L	57 - 61	1
PowerDome MIPS	91955 8	titan	shiny	240	S	51 - 55	1
PowerDome MIPS	91956 5	titan	shiny	260	M	54 - 58	1
PowerDome MIPS	91957 2	titan	shiny	280	L	57 - 61	1
PowerDome MIPS	91958 9	shiny white	shiny	240	S	51 - 55	1
PowerDome MIPS	91959 6	shiny white	shiny	260	M	54 - 58	1
PowerDome MIPS	91960 2	shiny white	shiny	280	L	57 - 61	1
PowerDome MIPS	91961 9	goldfish orange	shiny	240	S	51 - 55	1
PowerDome MIPS	91962 6	goldfish orange	shiny	260	M	54 - 58	1
PowerDome MIPS	91963 3	goldfish orange	shiny	280	L	57 - 61	1
PowerDome MIPS	91964 0	blaze red	shiny	240	S	51 - 55	1
PowerDome MIPS	91965 7	blaze red	shiny	260	M	54 - 58	1
PowerDome MIPS	91966 4	blaze red	shiny	280	L	57 - 61	1
PowerDome MIPS	91967 1	flip flop purple	shiny	240	S	51 - 55	1
PowerDome MIPS	91968 8	flip flop purple	shiny	260	M	54 - 58	1
PowerDome MIPS	91969 5	flip flop purple	shiny	280	L	57 - 61	1



WINGBACK

VIEWS



flip flop purple



flip flop purple



FEATURES



Zoom Ace



FlowStraps

TECHNOLOGY



VERSIONS



velvet black



titan



race grey



shiny white



performance red



goldfish orange



gleam silver



moss green



polar white

Ref. No.	EAN 4003318	Colour	Finish	Weight g	Size	Head Size cm	Box Qty
WingBack	98056 5	velvet black	matt	230	S	51 - 55	1
WingBack	98057 2	velvet black	matt	250	M	54 - 58	1
WingBack	98058 9	velvet black	matt	270	L	57 - 61	1
WingBack	98059 6	titan	shiny	230	S	51 - 55	1
WingBack	98060 2	titan	shiny	250	M	54 - 58	1
WingBack	98061 9	titan	shiny	270	L	57 - 61	1
WingBack	98062 6	race grey	shiny	230	S	51 - 55	1
WingBack	98063 3	race grey	shiny	250	M	54 - 58	1
WingBack	98064 0	race grey	shiny	270	L	57 - 61	1
WingBack	98065 7	shiny white	shiny	230	S	51 - 55	1
WingBack	98066 4	shiny white	shiny	250	M	54 - 58	1
WingBack	98067 1	shiny white	shiny	270	L	57 - 61	1
WingBack	98068 8	performance red	shiny	230	S	51 - 55	1
WingBack	98069 5	performance red	shiny	250	M	54 - 58	1
WingBack	98070 1	performance red	shiny	270	L	57 - 61	1
WingBack	98071 8	flip flop purple	shiny	230	S	51 - 55	1
WingBack	98072 5	flip flop purple	shiny	250	M	54 - 58	1
WingBack	98073 2	flip flop purple	shiny	270	L	57 - 61	1
WingBack	98074 9	goldfish orange	shiny	230	S	51 - 55	1
WingBack	98075 6	goldfish orange	shiny	250	M	54 - 58	1
WingBack	98076 3	goldfish orange	shiny	270	L	57 - 61	1
WingBack	98077 0	gleam silver	shiny	230	S	51 - 55	1
WingBack	98078 7	gleam silver	shiny	250	M	54 - 58	1
WingBack	98079 4	gleam silver	shiny	270	L	57 - 61	1
WingBack	98080 0	moss green	shiny	230	S	51 - 55	1
WingBack	98081 7	moss green	shiny	250	M	54 - 58	1
WingBack	98082 4	moss green	shiny	270	L	57 - 61	1
WingBack	98083 1	polar white	matt	230	S	51 - 55	1
WingBack	98084 8	polar white	matt	250	M	54 - 58	1
WingBack	98085 5	polar white	matt	270	L	57 - 61	1



MACATOR

VIEWS



matt titan



matt titan



FEATURES



Zoom Ace



Buckle

ACCESSOIRES

- ABUS Bag
- Race Cap

TECHNOLOGY



VERSIONS



white silver

velvet black

titan

steel blue

signal yellow

shiny rose

race grey



pearl white

midnight blue

gleam silver

blaze red

matt black

matt blue

velvet black



signal yellow



polar white



pearl white



shiny black

Ref. No.	EAN 4003318	Colour	Finish	Weight g	Size	Head Size cm	Box Qty
Macator	87232 7	white silver	shiny	280	S	51 - 55	1
Macator	87233 4	white silver	shiny	300	M	52 - 58	1
Macator	87234 1	white silver	shiny	360	L	58 - 62	1
Macator	87214 3	velvet black	shiny	280	S	51 - 55	1
Macator	87212 9	velvet black	shiny	300	M	52 - 58	1
Macator	87213 6	velvet black	shiny	360	L	58 - 62	1
Macator	87215 0	titan	shiny	280	S	51 - 55	1
Macator	87216 7	titan	shiny	300	M	52 - 58	1
Macator	87217 4	titan	shiny	360	L	58 - 62	1
Macator	87242 6	steel blue	shiny	280	S	51 - 55	1
Macator	87243 3	steel blue	shiny	300	M	52 - 58	1
Macator	87244 0	steel blue	shiny	360	L	58 - 62	1
Macator	87229 7	signal yellow	shiny	280	S	51 - 55	1
Macator	87230 3	signal yellow	shiny	300	M	52 - 58	1
Macator	87231 0	signal yellow	shiny	360	L	58 - 62	1
Macator	67334 4	shiny rose	shiny	280	S	51 - 55	1
Macator	67335 1	shiny rose	shiny	300	M	52 - 58	1
Macator	67336 8	shiny rose	shiny	360	L	58 - 62	1
Macator	67328 3	race grey	shiny	280	S	51 - 55	1
Macator	67329 0	race grey	shiny	300	M	52 - 58	1
Macator	67330 6	race grey	shiny	360	L	58 - 62	1
Macator	67331 3	pearl white	shiny	280	S	51 - 55	1
Macator	67332 0	pearl white	shiny	300	M	52 - 58	1
Macator	67333 7	pearl white	shiny	360	L	58 - 62	1
Macator	67325 2	midnight blue	shiny	280	S	51 - 55	1
Macator	67326 9	midnight blue	shiny	300	M	52 - 58	1
Macator	67327 6	midnight blue	shiny	360	L	58 - 62	1
Macator	87218 1	gleam silver	shiny	280	S	51 - 55	1
Macator	87219 8	gleam silver	shiny	300	M	52 - 58	1
Macator	87220 4	gleam silver	shiny	360	L	58 - 62	1
Macator	87221 1	blaze red	shiny	280	S	51 - 55	1
Macator	87222 8	blaze red	shiny	300	M	52 - 58	1
Macator	87223 5	blaze red	shiny	360	L	58 - 62	1
Macator	91183 5	matt black	matt	280	S	51 - 55	1
Macator	91184 2	matt black	matt	300	M	52 - 58	1
Macator	91185 9	matt black	matt	360	L	58 - 62	1
Macator	95591 4	matt blue	matt	280	S	51 - 55	1
Macator	95592 1	matt blue	matt	270	M	52 - 58	1
Macator	95593 8	matt blue	matt	360	L	58 - 62	1
Macator	95588 4	matt titan	matt	280	S	51 - 55	1
Macator	95589 1	matt titan	matt	270	M	52 - 58	1
Macator	95590 7	matt titan	matt	360	L	58 - 62	1
Macator MIPS	89217 2	velvet black	shiny	370	L	58 - 62	1
Macator MIPS	89218 9	velvet black	shiny	320	M	52 - 58	1
Macator MIPS	89219 6	velvet black	shiny	290	S	51 - 55	1
Macator MIPS	89220 2	signal yellow	shiny	370	L	58 - 62	1
Macator MIPS	89221 9	signal yellow	shiny	320	M	52 - 58	1
Macator MIPS	89222 6	signal yellow	shiny	290	S	51 - 55	1
Macator MIPS	89223 3	polar white	matt	370	L	58 - 62	1
Macator MIPS	89224 0	polar white	matt	320	M	52 - 58	1
Macator MIPS	89225 7	polar white	matt	290	S	51 - 55	1
Macator MIPS	96146 5	pearl white	shiny	270	S	51 - 55	1
Macator MIPS	96147 2	pearl white	shiny	290	M	52 - 58	1
Macator MIPS	96148 9	pearl white	shiny	310	L	58 - 62	1
Macator MIPS	96149 6	shiny black	shiny	270	S	51 - 55	1
Macator MIPS	96150 2	shiny black	shiny	290	M	52 - 58	1
Macator MIPS	96151 9	shiny black	shiny	310	L	58 - 62	1

MTB



AIRDROP

				
<small>Mips</small>	<small>Mips</small>	<small>Mips</small>	<small>Mips</small>	<small>Mips</small>
concrete grey	black gold	polar white	velvet black	velvet black
Page 182	Page 182	Page 182	Page 182	Page 182

HIDROP

			
★	★	★	★
midnight blue	shiny black	shiny white	moss green
Page 184	Page 184	Page 184	Page 184

CLIFFHANGER

					
Ti silver	concrete grey	iced mint	midnight blue	pine green	shiny white
Page 186	Page 186	Page 186	Page 186	Page 186	Page 186

					
velvet black	chalk grey	wildberry red	metallic copper	pine green	shiny white
Page 186	Page 186	Page 186	Page 186	Page 186	Page 186

				
<small>Mips</small>	<small>Mips</small>	<small>Mips</small>	<small>Mips</small>	<small>Mips</small>
iced mint	concrete grey	velvet black	velvet black	shiny white
Page 186	Page 186	Page 186	Page 186	Page 186

MOVENTOR 2.0



wildberry red

Page 188



concrete grey

Page 188



iced mint

Page 188



midnight blue

Page 188



pine green

Page 188



shiny white

Page 188



velvet black

Page 188



chalk grey

Page 188



Ti silver

Page 188



metallic copper

Page 188



velvet black

Page 188



concrete grey

Page 188



iced mint

Page 188



pine green

Page 188



shiny white

Page 188



shiny white

Page 188



velvet black

Page 188



chalk grey

Page 190



pine green

Page 190



velvet black

Page 190



concrete grey

Page 190



midnight blue

Page 190



iced mint

Page 190



polar white

Page 190



wildberry red

Page 190



Ti silver

Page 190



velvet black

Page 190



concrete grey

Page 190



metallic copper

Page 190



shiny white

Page 190



pine green

Page 190



iced mint

Page 190



polar white

Page 190



velvet black

Page 190

MODROP



MOTRIP

shiny white

Page 192

shiny black

Page 192

midnight blue

Page 192

concrete grey

Page 192

shiny black

Page 192

shiny white

Page 192



BUTEO

polar white

Page 194

infra red

Page 194

neon yellow

Page 194

velvet black

Page 194

AIRDROP

VIEWS



concrete grey



concrete grey



Mips

ACCESSORIES

- Quin Sensor
- Buteo velvet black
- Buteo polar white
- Buteo neon yellow
- Buteo infra red

FEATURES



Zoom Ace FF



BreakAway Visor



Double D buckle



Collarbone protection



ASC (Ambient Sound Channel)

TECHNOLOGY



VERSIONS



Mips

black gold



Mips

polar white



Mips

velvet black



Mips

velvet black

Ref. No.	EAN 4003318	Colour	Finish	Weight g	Size	Head size cm	Box Qty
AirDrop MIPS	66254 6	black gold	matt	790	S/M	52 - 58	1
AirDrop MIPS	66255 3	black gold	matt	890	L/XL	58 - 62	1
AirDrop MIPS	66024 5	concrete grey	matt	790	S/M	52 - 58	1
AirDrop MIPS	66026 9	concrete grey	matt	890	L/XL	58 - 62	1
AirDrop MIPS	66022 1	polar white	matt	790	S/M	52 - 58	1
AirDrop MIPS	66023 8	polar white	matt	890	L/XL	58 - 62	1
AirDrop MIPS	65800 6	velvet black	matt	790	S/M	52 - 58	1
AirDrop MIPS	66021 4	velvet black	matt	890	L/XL	58 - 62	1
AirDrop MIPS QUIN	66287 4	velvet black	matt	795	S/M	52 - 58	1
AirDrop MIPS QUIN	66288 1	velvet black	matt	895	L/XL	58 - 62	1
Quin Sensor	68838 6						1



HIDROP

VIEWS



midnight blue



midnight blue



FEATURES



Double D buckle



BreakAway Visor

ACCESSORIES

- Buteo

TECHNOLOGY



VERSIONS



shiny black



shiny white



moss green

Ref. No.	EAN 4003318	Colour	Finish	Weight g	Size	Head size cm	Box Qty
HiDrop	98091 6	shiny black	shiny	1090	S	55 - 56	1
HiDrop	98092 3	shiny black	shiny	1070	M	57 - 58	1
HiDrop	98093 0	shiny black	shiny	1050	L	59 - 60	1
HiDrop	98094 7	shiny black	shiny	1040	XL	61 - 62	1
HiDrop	98095 4	shiny white	shiny	1090	S	55 - 56	1
HiDrop	98096 1	shiny white	shiny	1070	M	57 - 58	1
HiDrop	98097 8	shiny white	shiny	1050	L	59 - 60	1
HiDrop	98098 5	shiny white	shiny	1040	XL	61 - 62	1
HiDrop	98099 2	moss green	shiny	1090	S	55 - 56	1
HiDrop	98100 5	moss green	shiny	1070	M	57 - 58	1
HiDrop	98101 2	moss green	shiny	1050	L	59 - 60	1
HiDrop	98102 9	moss green	shiny	1040	XL	61 - 62	1
HiDrop	98103 6	midnight blue	shiny	1090	S	55 - 56	1
HiDrop	98104 3	midnight blue	shiny	1070	M	57 - 58	1
HiDrop	98105 0	midnight blue	shiny	1050	L	59 - 60	1
HiDrop	98106 7	midnight blue	shiny	1040	XL	61 - 62	1

MTB



CLIFFHANGER

VIEWS



Ti silver



Ti silver



FEATURES



Zoom Ace MTB



Fidlock



TriVider



GoggFit



Height adjustable Visor

ACCESSORIES

- Quin Sensor Slim

TECHNOLOGY



VERSIONS



concrete grey

iced mint

midnight blue matt

pine green

shiny white

velvet black

chalk grey



wildberry red



metallic copper



pine green



shiny white



iced mint



concrete grey



velvet black



velvet black



shiny white

Ref. No.	EAN 4003318	Colour	Finish	Weight g	Size	Head size cm	Box Qty
CliffHanger	65539 5	concrete grey	matt	300	S	51 - 55	1
CliffHanger	65540 1	concrete grey	matt	325	M	54 - 58	1
CliffHanger	65541 8	concrete grey	matt	365	L	57 - 61	1
CliffHanger	65537 1	iced mint	shiny	300	S	51 - 55	1
CliffHanger	65538 8	iced mint	shiny	325	M	54 - 58	1
CliffHanger	66695 7	iced mint	shiny	365	L	57 - 61	1
CliffHanger	65531 9	midnight blue	matt	300	S	51 - 55	1
CliffHanger	65532 6	midnight blue	matt	325	M	54 - 58	1
CliffHanger	65533 3	midnight blue	matt	365	L	57 - 61	1
CliffHanger	65534 0	pine green	matt	300	S	51 - 55	1
CliffHanger	65535 7	pine green	matt	325	M	54 - 58	1
CliffHanger	65536 4	pine green	matt	365	L	57 - 61	1
CliffHanger	65528 9	shiny white	shiny	300	S	51 - 55	1
CliffHanger	65529 6	shiny white	shiny	325	M	54 - 58	1
CliffHanger	65530 2	shiny white	shiny	365	L	57 - 61	1
CliffHanger	65525 8	velvet black	matt	300	S	51 - 55	1
CliffHanger	65526 5	velvet black	matt	325	M	54 - 58	1
CliffHanger	65527 2	velvet black	matt	365	L	57 - 61	1
CliffHanger	67242 2	Ti silver	matt	300	S	51 - 55	1
CliffHanger	67243 9	Ti silver	matt	325	M	54 - 58	1
CliffHanger	67244 6	Ti silver	matt	365	L	57 - 61	1
CliffHanger	66240 9	chalk grey	matt	300	S	51 - 55	1
CliffHanger	66253 9	chalk grey	matt	325	M	54 - 58	1
CliffHanger	67238 5	chalk grey	matt	365	L	57 - 61	1
CliffHanger	67239 2	wildberry red	matt	300	S	51 - 55	1
CliffHanger	67240 8	wildberry red	matt	325	M	54 - 58	1
CliffHanger	67241 5	wildberry red	matt	365	L	57 - 61	1
CliffHanger MIPS	65551 7	metallic copper	matt	330	S	51 - 55	1
CliffHanger MIPS	65552 4	metallic copper	matt	350	M	54 - 58	1
CliffHanger MIPS	65553 1	metallic copper	matt	390	L	57 - 61	1
CliffHanger MIPS	67248 4	pine green	matt	330	S	51 - 55	1
CliffHanger MIPS	67249 1	pine green	matt	350	M	54 - 58	1
CliffHanger MIPS	67306 1	pine green	matt	390	L	57 - 61	1
CliffHanger MIPS	67245 3	shiny white	shiny	330	S	51 - 55	1
CliffHanger MIPS	67246 0	shiny white	shiny	350	M	54 - 58	1
CliffHanger MIPS	67247 7	shiny white	shiny	390	L	57 - 61	1
CliffHanger MIPS	67310 8	iced mint	matt	330	S	51 - 55	1
CliffHanger MIPS	67507 2	iced mint	matt	350	M	54 - 58	1
CliffHanger MIPS	67508 9	iced mint	matt	390	L	57 - 61	1
CliffHanger MIPS	65554 8	concrete grey	matt	330	S	51 - 55	1
CliffHanger MIPS	66485 4	concrete grey	matt	350	M	54 - 58	1
CliffHanger MIPS	65555 5	concrete grey	matt	390	L	57 - 61	1
CliffHanger MIPS	65542 5	velvet black	matt	330	S	51 - 55	1
CliffHanger MIPS	65543 2	velvet black	matt	350	M	54 - 58	1
CliffHanger MIPS	65544 9	velvet black	matt	390	L	57 - 61	6
CliffHanger QUIN	65556 2	velvet black	matt	305	S	51 - 55	1
CliffHanger QUIN	65557 9	velvet black	matt	330	M	54 - 58	1
CliffHanger QUIN	65558 6	velvet black	matt	370	L	57 - 61	1
CliffHanger QUIN	65734 4	shiny white	shiny	305	S	51 - 55	1
CliffHanger QUIN	65737 5	shiny white	shiny	330	M	54 - 58	1
CliffHanger QUIN	65738 2	shiny white	shiny	370	L	57 - 61	1
Quin Sensor Slim	69319 9						1

MTB



MOVENTOR 2.0

VIEWS



wildberry red



wildberry red



FEATURES



Zoom Ace MTB



Buckle



GogFit



TriVider



Height adjustable
Visor

ACCESSORIES

- ABUS Bag
- Quin Sensor
- Padding fly net Moventor 2.0 S/M/L

TECHNOLOGY



VERSIONS



concrete grey



iced mint



midnight blue



pine green



shiny white



velvet black



chalk grey



Ti silver



Mips metallic copper



Mips velvet black



Mips concrete grey



Mips iced mint



Mips pine green



Mips shiny white



Mips shiny white



Mips velvet black

Ref. No.	EAN 4003318	Colour	Finish	Weight g	Size	Head size cm	Box Qty
Moventor 2.0	65502 9	concrete grey	shiny	290	S	51 - 55	1
Moventor 2.0	65503 6	concrete grey	shiny	300	M	54 - 58	1
Moventor 2.0	65504 3	concrete grey	shiny	320	L	57 - 61	1
Moventor 2.0	65505 0	iced mint	shiny	290	S	51 - 55	1
Moventor 2.0	65506 7	iced mint	shiny	300	M	54 - 58	1
Moventor 2.0	65507 4	iced mint	shiny	320	L	57 - 61	1
Moventor 2.0	65496 1	midnight blue	shiny	290	S	51 - 55	1
Moventor 2.0	65497 8	midnight blue	shiny	300	M	54 - 58	1
Moventor 2.0	65498 5	midnight blue	shiny	320	L	57 - 61	1
Moventor 2.0	65499 2	pine green	shiny	290	S	51 - 55	1
Moventor 2.0	65500 5	pine green	shiny	300	M	54 - 58	1
Moventor 2.0	65501 2	pine green	shiny	320	L	57 - 61	1
Moventor 2.0	65493 0	shiny white	shiny	290	S	51 - 55	1
Moventor 2.0	65494 7	shiny white	shiny	300	M	54 - 58	1
Moventor 2.0	65495 4	shiny white	shiny	320	L	57 - 61	1
Moventor 2.0	65490 9	velvet black	matt	290	S	51 - 55	1
Moventor 2.0	65491 6	velvet black	matt	300	M	54 - 58	1
Moventor 2.0	65492 3	velvet black	matt	320	L	57 - 61	1
Moventor 2.0	74661 1	chalk grey	matt	290	S	51 - 55	1
Moventor 2.0	78600 6	chalk grey	matt	300	M	54 - 58	1
Moventor 2.0	83317 5	chalk grey	matt	320	L	57 - 61	1
Moventor 2.0	83318 2	wildberry red	matt	290	S	51 - 55	1
Moventor 2.0	83319 9	wildberry red	matt	300	M	54 - 58	1
Moventor 2.0	83320 5	wildberry red	matt	320	L	57 - 61	1
Moventor 2.0	83321 2	Ti silver	matt	290	S	51 - 55	1
Moventor 2.0	84127 9	Ti silver	matt	300	M	54 - 58	1
Moventor 2.0	84250 4	Ti silver	matt	320	L	57 - 61	1
Moventor 2.0 MIPS	65511 1	metallic copper	shiny	320	S	51 - 55	1
Moventor 2.0 MIPS	65512 8	metallic copper	shiny	330	M	54 - 58	1
Moventor 2.0 MIPS	65513 5	metallic copper	shiny	350	L	51 - 61	1
Moventor 2.0 MIPS	65508 1	velvet black	matt	320	S	51 - 55	1
Moventor 2.0 MIPS	65509 8	velvet black	matt	330	M	54 - 58	1
Moventor 2.0 MIPS	65510 4	velvet black	matt	350	L	57 - 61	1
Moventor 2.0 MIPS	65514 2	concrete grey	shiny	320	S	51 - 55	1
Moventor 2.0 MIPS	65515 9	concrete grey	shiny	330	M	54 - 58	1
Moventor 2.0 MIPS	65516 6	concrete grey	shiny	350	L	57 - 61	1
Moventor 2.0 MIPS	88487 0	iced mint	matt	320	S	51 - 55	1
Moventor 2.0 MIPS	88488 7	iced mint	matt	330	M	54 - 58	1
Moventor 2.0 MIPS	88493 1	iced mint	matt	350	L	57 - 61	1
Moventor 2.0 MIPS	87870 1	pine green	matt	320	S	51 - 55	1
Moventor 2.0 MIPS	88465 8	pine green	matt	330	M	54 - 58	1
Moventor 2.0 MIPS	88466 5	pine green	matt	350	L	57 - 61	1
Moventor 2.0 MIPS	84522 2	shiny white	matt	320	S	51 - 55	1
Moventor 2.0 MIPS	84523 9	shiny white	matt	330	M	54 - 58	1
Moventor 2.0 MIPS	85421 7	shiny white	matt	350	L	57 - 61	1
Moventor 2.0 QUIN	65517 3	velvet black	matt	295	S	51 - 55	1
Moventor 2.0 QUIN	65518 0	velvet black	matt	305	M	54 - 58	1
Moventor 2.0 QUIN	65519 7	velvet black	matt	325	L	57 - 61	1
Moventor 2.0 QUIN	65520 3	shiny white	shiny	295	S	51 - 55	1
Moventor 2.0 QUIN	65521 0	shiny white	shiny	305	M	54 - 58	1
Moventor 2.0 QUIN	65522 7	shiny white	shiny	325	L	57 - 61	1
Quin Sensor	68838 6						1

MTB



MODROP

VIEWS



chalk grey



chalk grey



FEATURES



Zoom Ace MTB



Buckle



TriVider



GoggFit



Height adjustable Visor

ACCESSORIES

- ABUS Bag
- Quin Sensor
- Padding fly net MoTrip S/M/L

TECHNOLOGY



VERSIONS



pine green

velvet black

concrete grey

midnight blue

iced mint

polar white

wildberry red



Ti silver

velvet black

concrete grey

metallic copper

shiny white

pine green

iced mint



polar white

velvet black

Ref. No.	EAN 4003318	Colour	Finish	Weight g	Size	Head size cm	Box Qty
MoDrop	64985 1	pine green	matt	310	S	51 - 55	1
MoDrop	64986 8	pine green	matt	330	M	54 - 58	1
MoDrop	64987 5	pine green	matt	360	L	57 - 61	1
MoDrop	64849 6	velvet black	matt	310	S	51 - 55	1
MoDrop	64851 9	velvet black	matt	330	M	54 - 58	1
MoDrop	64850 2	velvet black	matt	360	L	57 - 61	1
MoDrop	64852 6	concrete grey	matt	310	S	51 - 55	1
MoDrop	64853 3	concrete grey	matt	330	M	54 - 58	1
MoDrop	64854 0	concrete grey	matt	360	L	57 - 61	1
MoDrop	64861 8	midnight blue	matt	310	S	51 - 55	1
MoDrop	64863 2	midnight blue	matt	330	M	54 - 58	1
MoDrop	64871 7	midnight blue	matt	360	L	57 - 61	1
MoDrop	64988 2	iced mint	matt	310	S	51 - 55	1
MoDrop	64989 9	iced mint	matt	330	M	54 - 58	1
MoDrop	64990 5	iced mint	matt	360	L	57 - 61	1
MoDrop	66475 5	polar white	matt	310	S	51 - 55	1
MoDrop	66476 2	polar white	matt	330	M	54 - 58	1
MoDrop	66477 9	polar white	matt	360	L	57 - 61	1
MoDrop	67601 7	wildberry red	matt	310	S	51 - 55	1
MoDrop	67612 3	wildberry red	matt	330	M	54 - 58	1
MoDrop	68077 9	wildberry red	matt	360	L	57 - 61	1
MoDrop	68981 9	Ti silver	matt	310	S	51 - 55	1
MoDrop	69056 3	Ti silver	matt	330	M	54 - 58	1
MoDrop	69079 2	Ti silver	matt	360	L	57 - 61	1
MoDrop	67531 7	chalk grey	matt	310	S	51 - 55	1
MoDrop	67585 0	chalk grey	matt	330	M	54 - 58	1
MoDrop	67594 2	chalk grey	matt	360	L	57 - 61	1
MoDrop MIPS	65739 9	velvet black	matt	340	S	51 - 55	1
MoDrop MIPS	65740 5	velvet black	matt	370	M	54 - 58	1
MoDrop MIPS	65741 2	velvet black	matt	390	L	57 - 61	1
MoDrop MIPS	65755 9	concrete grey	matt	340	S	51 - 55	1
MoDrop MIPS	65756 6	concrete grey	matt	370	M	54 - 58	1
MoDrop MIPS	65757 3	concrete grey	matt	390	L	57 - 61	1
MoDrop MIPS	65742 9	metallic copper	matt	340	S	51 - 55	1
MoDrop MIPS	65753 5	metallic copper	matt	370	M	54 - 58	1
MoDrop MIPS	65754 2	metallic copper	matt	390	L	57 - 61	1
MoDrop MIPS	69080 8	shiny white	shiny	340	S	51 - 55	1
MoDrop MIPS	69106 5	shiny white	shiny	370	M	54 - 58	1
MoDrop MIPS	69180 5	shiny white	shiny	390	L	57 - 61	1
MoDrop MIPS	69383 0	pine green	matt	340	S	51 - 55	1
MoDrop MIPS	69384 7	pine green	matt	370	M	54 - 58	1
MoDrop MIPS	72993 5	pine green	matt	390	L	57 - 61	1
MoDrop MIPS	72996 6	iced mint	matt	340	S	51 - 55	1
MoDrop MIPS	72997 3	iced mint	matt	370	M	54 - 58	1
MoDrop MIPS	72998 0	iced mint	matt	390	L	57 - 61	1
MoDrop QUIN	65797 9	polar white	matt	315	S	51 - 55	1
MoDrop QUIN	65798 6	polar white	matt	335	M	54 - 58	1
MoDrop QUIN	65799 3	polar white	matt	365	L	57 - 61	1
MoDrop QUIN	65758 0	velvet black	matt	315	S	51 - 55	1
MoDrop QUIN	65795 5	velvet black	matt	335	M	54 - 58	1
MoDrop QUIN	65796 2	velvet black	matt	365	L	57 - 61	1
Quin Sensor	68838 6						1



MOTRIP

VIEWS



shiny white



shiny white



FEATURES



Zoom Ace MTB



Buckle



GogFit



Height adjustable
Visor

ACCESSORIES

- ABUS Bag
- Padding fly net MoTrip S/M/L

TECHNOLOGY



VERSIONS



shiny black



midnight blue



concrete grey



shiny black



shiny white

Ref. No.	EAN 4003318	Colour	Finish	Weight g	Size	Head size cm	Box Qty
MoTrip	64709 3	shiny white	shiny	320	S	51 - 55	1
MoTrip	64712 3	shiny white	shiny	340	M	54 - 58	1
MoTrip	64710 9	shiny white	shiny	350	L	57 - 61	1
MoTrip	64706 2	shiny black	shiny	320	S	51 - 55	1
MoTrip	64707 9	shiny black	shiny	340	M	54 - 58	1
MoTrip	64708 6	shiny black	shiny	350	L	57 - 61	1
MoTrip	64711 6	midnight blue	shiny	320	S	51 - 55	1
MoTrip	64713 0	midnight blue	shiny	340	M	54 - 58	1
MoTrip	64714 7	midnight blue	shiny	350	L	57 - 61	1
MoTrip	64724 6	concrete grey	shiny	320	S	51 - 55	1
MoTrip	64754 3	concrete grey	shiny	340	M	54 - 58	1
MoTrip	64847 2	concrete grey	shiny	350	L	57 - 61	1
MoTrip MIPS	88496 2	shiny black	shiny	350	S	51 - 55	1
MoTrip MIPS	88499 3	shiny black	shiny	370	M	54 - 58	1
MoTrip MIPS	88508 2	shiny black	shiny	380	L	57 - 61	1
MoTrip MIPS	88821 2	shiny white	shiny	350	S	51 - 55	1
MoTrip MIPS	89177 9	shiny white	shiny	380	L	57 - 61	1
MoTrip MIPS	88977 6	shiny white	shiny	370	M	54 - 58	1

MTB



BUTEO



TECHNICAL DATA

- Double layer glass to prevent fogging
- 40 mm strap for slip-free fit
- Fleece layer for maximum comfort
- Nose guard for a comfortable and secure fit
- Available with clear and mirrored tinted lenses

VERSIONS



infra red

neon yellow

velvet black

Ref. No.	EAN 4003318	Colour	Weight g	Size	Box Qty
Buteo infra red	68933 8	infra red	140	universal	1
Buteo neon yellow	68932 1	neon yellow	140	universal	1
Buteo polar white	68931 4	polar white	140	universal	1
Buteo velvet black	68930 7	velvet black	140	universal	1
Spare glass Buteos	68934 5	clear	15	universal	1
Spare glass Buteos	68935 2	smoke	15	universal	1
Spare glass Buteos	68936 9	red chrome	15	universal	1
Spare glass Buteos	68937 6	black chrome	15	universal	1



URBAN



ADURO 3.0

ABUS

PEDELEC 2.0 ACE



champagne gold

Page 204



velvet black

Page 204



signal yellow

Page 204



pearl white

Page 204



midnight blue

Page 204



race grey

Page 204



titan

Page 204



blaze red

Page 204



race grey

Page 206



velvet black

Page 206



signal yellow

Page 206



pearl white

Page 206



midnight blue

Page 206



titan

Page 206

PEDELEC 2.0



champagne gold

Page 206



blaze red

Page 206



velvet black

Page 206



signal yellow

Page 206



silver edition

Page 206



steel blue

Page 208



titan

Page 208



pearl white

Page 208



black edition

Page 208

PEDELEC 1.1

Urban

HUD-Y ACE



champagne gold

Page 210



gleam silver

Page 210



iced blue

Page 210



moss green

Page 210



shiny white

Page 210



goldfish orange

Page 210



velvet black

Page 210

HUD-Y



iced blue

Page 212



metallic copper

Page 212



moss green

Page 212



gleam silver

Page 212



velvet black

Page 212



titan

Page 212



signal yellow

Page 212



race grey

Page 212



midnight blue

Page 212



flower white

Page 212



champagne gold

Page 212



shiny white

Page 212



goldfish orange

Page 212

URBAN-I 3.0 ACE



gleam silver

Page 214



moss green

Page 214



iced blue

Page 214



velvet black

Page 214



goldfish orange

Page 214



polar white

Page 214



metallic copper

Page 214

URBAN-I 3.0



velvet black

Page 216



titan

Page 216



street art

Page 216



polar white

Page 216



living coral

Page 216



jade green

Page 216



glacier blue

Page 216



flower art

Page 216



core green

Page 216



core blue

Page 216



Signal yellow

Page 216



signal silver

Page 216



signal orange

Page 216



velvet black

Page 216



titan

Page 216



signal yellow

Page 216

PURL-Y ACE



midnight blue

Page 218



velvet black

Page 218



titan

Page 218



polar white

Page 218



metallic copper

Page 218



moss green

Page 218



champagne gold

Page 218



iced blue

Page 218



signal yellow

Page 218

PURL-Y



moss green

Page 220



shiny black

Page 220



titan

Page 220



shiny white

Page 220



metallic copper

Page 220



midnight blue

Page 220



champagne gold

Page 220



iced blue

Page 220



signal yellow

Page 220

HYBAN 2.0 LED



signal black

Page 222



signal yellow

Page 222



signal silver

Page 222



signal glacier

Page 222

HYBAN 2.0 ACE



titan

Page 224



velvet black

Page 224



signal yellow

Page 224



polar white

Page 224

HYBAN 2.0



chrome silver

Page 226



velvet black

Page 226



titan

Page 226



polar white

Page 226



living coral

Page 226



jade green

Page 226



glacier blue

Page 226



core green

Page 226



core blue

Page 226



chrome rosé

Page 226



signal orange

Page 226



signal silver

Page 226



signal yellow

Page 226



velvet black

Page 226



titan

Page 226



signal yellow

Page 226

SKURB ACE



city vibes

Page 228



goldfish orange

Page 228



moss green

Page 228



velvet black

Page 228



silver white

Page 228



glacier blue

Page 228

SKURB



goldfish orange

Page 230



moss green

Page 230



velvet black

Page 230



titan

Page 230



pearl white

Page 230



midnight blue

Page 230



velvet black

Page 230



polar white

Page 230



concrete grey

Page 230

SCRAPER 3.0 ACE



ultra blue

Page 232



velvet black

Page 232



concrete grey

Page 232

SCRAPER 3.0



velvet black

Page 234



concrete grey

Page 234



ultra blue

Page 234



signal orange

Page 234



polar matt

Page 234

ADURO 3.0



purple waves

Page 236



velvet black

Page 236



polar white

Page 236



midnight blue

Page 236



titan

Page 236



race black

Page 236



glacier blue

Page 236



blaze red

Page 236



race grey

Page 236



maori
blackberry

Page 236



white art

Page 236



orange palm

Page 236



signal yellow

Page 236

PEDELEC 2.0 ACE

VIEWS



champagne gold



champagne gold



FEATURES



Zoom Ace Urban



Fidlock



GlowStraps



USB-light



Raincap

ACCESSORIES

- Visor smoke
Pedelec 2.0,
Hyban 2.0, HUD-Y
- ABUS Bag

TECHNOLOGY



NTA 8776

VERSIONS



velvet black



signal yellow



pearl white



midnight blue



race grey



titan



blaze red

Ref. No.	EAN 4003318	Colour	Finish	Weight g	Size	Head Size cm	Box Qty
Pedelec 2.0 ACE	66732 9	velvet black	matt	390	S	51 - 55	1
Pedelec 2.0 ACE	81925 4	velvet black	matt	410	M	52 - 57	1
Pedelec 2.0 ACE	81929 2	velvet black	matt	430	L	56 - 62	1
Pedelec 2.0 ACE	66735 0	signal yellow	shiny	390	S	51 - 55	1
Pedelec 2.0 ACE	81928 5	signal yellow	shiny	410	M	52 - 57	1
Pedelec 2.0 ACE	81932 2	signal yellow	shiny	430	L	56 - 62	1
Pedelec 2.0 ACE	67337 5	pearl white	shiny	390	S	51 - 55	1
Pedelec 2.0 ACE	67338 2	pearl white	shiny	410	M	52 - 57	1
Pedelec 2.0 ACE	67339 9	pearl white	shiny	430	L	56 - 62	1
Pedelec 2.0 ACE	66736 7	midnight blue	matt	390	S	51 - 55	1
Pedelec 2.0 ACE	81927 8	midnight blue	matt	410	M	52 - 57	1
Pedelec 2.0 ACE	81931 5	midnight blue	matt	430	L	56 - 62	1
Pedelec 2.0 ACE	91909 1	race grey	shiny	390	S	51 - 55	1
Pedelec 2.0 ACE	91910 7	race grey	shiny	410	M	52 - 57	1
Pedelec 2.0 ACE	91911 4	race grey	shiny	430	L	56 - 62	1
Pedelec 2.0 ACE	91906 0	titan	matt	390	S	51 - 55	1
Pedelec 2.0 ACE	91907 7	titan	matt	410	M	52 - 57	1
Pedelec 2.0 ACE	91908 4	titan	matt	430	L	56 - 62	1
Pedelec 2.0 ACE	91912 1	champagne gold	shiny	390	S	51 - 55	1
Pedelec 2.0 ACE	91913 8	champagne gold	shiny	410	M	52 - 57	1
Pedelec 2.0 ACE	91914 5	champagne gold	shiny	430	L	56 - 62	1
Pedelec 2.0 ACE	91917 6	blaze red	shiny	390	S	51 - 55	1
Pedelec 2.0 ACE	91918 3	blaze red	shiny	410	M	52 - 57	1
Pedelec 2.0 ACE	91919 0	blaze red	shiny	430	L	56 - 62	1
Visor smoke Pedelec 2.0, Hyban 2.0, HUD-Y	82888 1	smoke			universal		1
Visor clear Pedelec 2.0, Hyban 2.0, HUD-Y	82889 8	clear			universal		1

Urban



PEDELEC 2.0

VIEWS



race grey



race grey



FEATURES



Zoom Ace Urban



Fidlock



GlowStraps



USB-light



Raincap

ACCESSORIES

- Shield & Earpads Pedelec 2.0/Hyban 2.0
- Visor smoke Pedelec 2.0, Hyban 2.0, HUD-Y
- Visor clear Pedelec 2.0, Hyban 2.0, HUD-Y
- Earpads Pedelec 2.0 black
- ABUS Bag

TECHNOLOGY



VERSIONS



velvet black

signal yellow

pearl white

midnight blue

titan

champagne gold

blaze red



Mips

velvet black



Mips

signal yellow



Mips

silver edition

Ref. No.	EAN 4003318	Colour	Finish	Weight g	Size	Head Size cm	Box Qty
Pedelec 2.0	40597 6	velvet black	matt	330	S	51 - 55	1
Pedelec 2.0	81919 3	velvet black	matt	350	M	52 - 57	1
Pedelec 2.0	81913 1	velvet black	matt	370	L	56 - 62	1
Pedelec 2.0	40595 2	signal yellow	shiny	330	S	51 - 55	1
Pedelec 2.0	81922 3	signal yellow	shiny	350	M	52 - 57	1
Pedelec 2.0	81916 2	signal yellow	shiny	370	L	56 - 62	1
Pedelec 2.0	40593 8	pearl white	shiny	330	S	51 - 55	1
Pedelec 2.0	40188 6	pearl white	shiny	350	M	52 - 57	1
Pedelec 2.0	40189 3	pearl white	shiny	370	L	56 - 62	1
Pedelec 2.0	40297 5	midnight blue	matt	330	S	51 - 55	1
Pedelec 2.0	81921 6	midnight blue	matt	350	M	52 - 57	1
Pedelec 2.0	81915 5	midnight blue	matt	370	L	56 - 62	1
Pedelec 2.0	91894 0	titan	matt	330	S	51 - 55	1
Pedelec 2.0	91895 7	titan	matt	350	M	52 - 57	1
Pedelec 2.0	91896 4	titan	matt	370	L	56 - 62	1
Pedelec 2.0	91900 8	champagne gold	shiny	330	S	51 - 55	1
Pedelec 2.0	91901 5	champagne gold	shiny	350	M	52 - 57	1
Pedelec 2.0	91902 2	champagne gold	shiny	370	L	56 - 62	1
Pedelec 2.0	91897 1	race grey	shiny	330	S	51 - 55	1
Pedelec 2.0	91898 8	race grey	shiny	350	M	52 - 57	1
Pedelec 2.0	91899 5	race grey	shiny	370	L	56 - 62	1
Pedelec 2.0	91903 9	blaze red	shiny	330	S	51 - 55	1
Pedelec 2.0	91904 6	blaze red	shiny	350	M	52 - 57	1
Pedelec 2.0	91905 3	blaze red	shiny	370	L	56 - 62	1
Pedelec 2.0 MIPS	89193 9	velvet black	matt	390	L	56 - 62	1
Pedelec 2.0 MIPS	89194 6	velvet black	matt	370	M	52 - 57	1
Pedelec 2.0 MIPS	89197 7	signal yellow	shiny	390	L	56 - 62	1
Pedelec 2.0 MIPS	89198 4	signal yellow	shiny	370	M	52 - 57	1
Pedelec 2.0 MIPS	89195 3	silver edition	matt	390	L	56 - 62	1
Pedelec 2.0 MIPS	89196 0	silver edition	matt	370	M	52 - 57	1

Urban



PEDELEC 1.1

VIEWS



steel blue



steel blue



FEATURES



Zoom Evo Adult



Fidlock



LED top



Raincap

ACCESSORIES

- ABUS Bag

TECHNOLOGY



NTA 8776

VERSIONS



titan



pearl white



black edition

Ref. No.	EAN 4003318	Colour	Finish	Weight g	Size	Head Size cm	Box Qty
Pedelec 1.1	81907 0	titan	matt	350	M	52 - 57	1
Pedelec 1.1	81908 7	titan	matt	370	L	56 - 62	1
Pedelec 1.1	81909 4	steel blue	shiny	350	M	52 - 57	1
Pedelec 1.1	81910 0	steel blue	shiny	370	L	56 - 62	1
Pedelec 1.1	81911 7	pearl white	shiny	350	M	52 - 57	1
Pedelec 1.1	81912 4	pearl white	shiny	370	L	56 - 62	1
Pedelec 1.1	81905 6	black edition	matt	350	M	52 - 57	1
Pedelec 1.1	81906 3	black edition	matt	370	L	56 - 62	1



Urban

HUD-Y ACE

VIEWS



champagne gold



champagne gold



FEATURES



Zoom Ace Urban



Fidlock



TriVider



Magnetic USB tail light

ACCESSORIES

- ABUS Bag
- Padding set
bugmesh black
HUD-Y S/M/L
- Visor smoke
Pedelec 2.0,
Hyban 2.0, HUD-Y
- Winter Kit

TECHNOLOGY



VERSIONS



gleam silver

iced blue

moss green

shiny white

goldfish orange

velvet black

Ref. No.	EAN 4003318	Colour	Finish	Weight g	Size	Head Size cm	Box Qty
HUD-Y ACE	99168 4	champange gold	matt	400	S	51 - 55	1
HUD-Y ACE	99169 1	champange gold	matt	430	M	54 - 58	1
HUD-Y ACE	99170 7	champange gold	matt	460	L	57 - 61	1
HUD-Y ACE	99165 3	gleam silver	shiny	400	S	51 - 55	1
HUD-Y ACE	99166 0	gleam silver	shiny	430	M	54 - 58	1
HUD-Y ACE	99167 7	gleam silver	shiny	460	L	57 - 61	1
HUD-Y ACE	99162 2	iced blue	shiny	400	S	51 - 55	1
HUD-Y ACE	99163 9	iced blue	shiny	430	M	54 - 58	1
HUD-Y ACE	99164 6	iced blue	shiny	460	L	57 - 61	1
HUD-Y ACE	99160 8	moss green	shiny	430	M	51 - 55	1
HUD-Y ACE	99161 5	moss green	shiny	460	L	54 - 58	1
HUD-Y ACE	99159 2	moss green	shiny	400	S	57 - 61	1
HUD-Y ACE	91995 4	shiny white	shiny	400	S	51 - 55	1
HUD-Y ACE	91996 1	shiny white	shiny	430	M	54 - 58	1
HUD-Y ACE	91997 8	shiny white	shiny	460	L	57 - 61	1
HUD-Y ACE	91998 5	goldfish orange	shiny	400	S	51 - 55	1
HUD-Y ACE	91999 2	goldfish orange	shiny	430	M	54 - 58	1
HUD-Y ACE	04486 1	goldfish orange	shiny	460	L	57 - 61	1
HUD-Y ACE	91992 3	velvet black	matt	400	S	51 - 55	1
HUD-Y ACE	91993 0	velvet black	matt	430	M	54 - 58	1
HUD-Y ACE	91994 7	velvet black	matt	460	L	57 - 61	1
Visor smoke Pedelec 2.0, Hyban 2.0, HUD-Y	82888 1	smoke			universal		1
Visor clear Pedelec 2.0, Hyban 2.0, HUD-Y	82889 8	clear			universal		1
Fastening visor Pedelec 2.0, Hyban 2.0, HUD-Y	82890 4				universal		1



HUD-Y

VIEWS



iced blue



iced blue



FEATURES



Zoom Ace Urban



Fidlock



TriVider



Magnetic USB tail light



Flipflop Visor

ACCESSORIES

- ABUS Bag
- USB-light

TECHNOLOGY



VERSIONS



metallic copper



moss green



gleam silver



velvet black



titan



signal yellow



race grey



midnight blue



flower white



champagne gold



shiny white



goldfish orange

Ref. No.	EAN 4003318	Colour	Finish	Weight g	Size	Head Size cm	Box Qty
HUD-Y	97932 3	metallic copper	matt	280	S	51 - 55	1
HUD-Y	97934 7	metallic copper	matt	300	M	54 - 58	1
HUD-Y	97935 4	metallic copper	matt	330	L	57 - 61	1
HUD-Y	97936 1	moss green	shiny	280	S	51 - 55	1
HUD-Y	97937 8	moss green	shiny	300	M	54 - 58	1
HUD-Y	97938 5	moss green	shiny	330	L	57 - 61	1
HUD-Y	97939 2	iced blue	shiny	280	S	51 - 55	1
HUD-Y	97940 8	iced blue	shiny	300	M	54 - 58	1
HUD-Y	97941 5	iced blue	shiny	330	L	57 - 61	1
HUD-Y	97942 2	gleam silver	shiny	280	S	51 - 55	1
HUD-Y	97943 9	gleam silver	shiny	300	M	54 - 58	1
HUD-Y	97944 6	gleam silver	shiny	330	L	57 - 61	1
HUD-Y	91979 4	velvet black	matt	280	S	51 - 55	1
HUD-Y	66843 2	velvet black	matt	300	M	54 - 58	1
HUD-Y	66844 9	velvet black	matt	330	L	57 - 61	1
HUD-Y	91980 0	titan	matt	280	S	51 - 55	1
HUD-Y	66947 7	titan	matt	300	M	54 - 58	1
HUD-Y	67038 1	titan	matt	330	L	57 - 61	1
HUD-Y	91983 1	signal yellow	shiny	280	S	51 - 55	1
HUD-Y	67043 5	signal yellow	shiny	300	M	54 - 58	1
HUD-Y	67044 2	signal yellow	shiny	330	L	57 - 61	1
HUD-Y	91985 5	race grey	shiny	280	S	51 - 55	1
HUD-Y	67934 6	race grey	shiny	300	M	54 - 58	1
HUD-Y	67935 3	race grey	shiny	330	L	57 - 61	1
HUD-Y	91982 4	midnight blue	matt	280	S	51 - 55	1
HUD-Y	67041 1	midnight blue	matt	300	M	54 - 58	1
HUD-Y	67042 8	midnight blue	matt	330	L	57 - 61	1
HUD-Y	91981 7	flower white	shiny	280	S	51 - 55	1
HUD-Y	66944 6	flower white	shiny	300	M	54 - 58	1
HUD-Y	66945 3	flower white	shiny	330	L	57 - 61	1
HUD-Y	91984 8	champagne gold	matt	280	S	51 - 55	1
HUD-Y	67039 8	champagne gold	matt	300	M	54 - 58	1
HUD-Y	67040 4	champagne gold	matt	330	L	57 - 61	1
HUD-Y	91986 2	shiny white	shiny	280	S	51 - 55	1
HUD-Y	91987 9	shiny white	shiny	300	M	54 - 58	1
HUD-Y	91988 6	shiny white	shiny	330	L	57 - 61	1
HUD-Y	91989 3	goldfish orange	shiny	280	S	51 - 55	1
HUD-Y	91990 9	goldfish orange	shiny	300	M	54 - 58	1
HUD-Y	91991 6	goldfish orange	shiny	330	L	57 - 61	1

Urban



URBAN-I 3.0 ACE

NEW

VIEWS



gleam silver



gleam silver



FEATURES



Zoom Ace Urban



Fidlock



LED



TriVider

ACCESSORIES

- ABUS Bag
- LED light

TECHNOLOGY



VERSIONS



moss green

iced blue

velvet black

goldfish orange

polar white

metallic copper

Ref. No.	EAN 4003318	Colour	Finish	Weight g	Size	Head Size cm	Box Qty
Urban-I 3.0 ACE	97948 4	moss green	shiny	250	S	51 - 55	1
Urban-I 3.0 ACE	97949 1	moss green	shiny	280	M	52 - 58	1
Urban-I 3.0 ACE	97950 7	moss green	shiny	300	L	56 - 61	1
Urban-I 3.0 ACE	97951 4	iced blue	shiny	250	S	51 - 55	1
Urban-I 3.0 ACE	97952 1	iced blue	shiny	280	M	52 - 58	1
Urban-I 3.0 ACE	97953 8	iced blue	shiny	300	L	56 - 61	1
Urban-I 3.0 ACE	97954 5	gleam silver	shiny	250	S	51 - 55	1
Urban-I 3.0 ACE	97955 2	gleam silver	shiny	280	M	52 - 58	1
Urban-I 3.0 ACE	97956 9	gleam silver	shiny	300	L	56 - 61	1
Urban-I 3.0 ACE	02940 0	velvet black	matt	250	S	51 - 55	1
Urban-I 3.0 ACE	02999 8	velvet black	matt	280	M	52 - 58	1
Urban-I 3.0 ACE	03244 8	velvet black	matt	300	L	56 - 61	1
Urban-I 3.0 ACE	03413 8	goldfish orange	shiny	250	S	51 - 55	1
Urban-I 3.0 ACE	03414 5	goldfish orange	shiny	280	M	52 - 58	1
Urban-I 3.0 ACE	03415 2	goldfish orange	shiny	300	L	56 - 61	1
Urban-I 3.0 ACE	03410 7	polar white	matt	250	S	51 - 55	1
Urban-I 3.0 ACE	03411 4	polar white	matt	280	M	52 - 58	1
Urban-I 3.0 ACE	03412 1	polar white	matt	300	L	56 - 61	1
Urban-I 3.0 ACE	03416 9	metallic copper	matt	250	S	51 - 55	1
Urban-I 3.0 ACE	03417 6	metallic copper	matt	280	M	52 - 58	1
Urban-I 3.0 ACE	03418 3	metallic copper	matt	300	L	56 - 61	1



URBAN-I 3.0

VIEWS



velvet black



velvet black



FEATURES



Zoom Ace Urban



Fidlock



LED top

ACCESSORIES

- ABUS Bag
- LED light

TECHNOLOGY



VERSIONS



titan



street art



polar white



living coral



jade green



glacier blue



flower art



core green



core blue



Signal yellow



signal silver



signal orange



velvet black



titan



signal yellow

Ref. No.	EAN 4003318	Colour	Finish	Weight g	Size	Head Size cm	Box Qty
Urban-I 3.0	86857 3	velvet black	matt	250	S	51 - 55	1
Urban-I 3.0	86851 1	velvet black	matt	280	M	52 - 58	1
Urban-I 3.0	86852 8	velvet black	matt	300	L	56 - 61	1
Urban-I 3.0	86853 5	velvet black	matt	325	XL	61 - 65	1
Urban-I 3.0	86862 7	titan	matt	250	S	51 - 55	1
Urban-I 3.0	86863 4	titan	matt	280	M	52 - 58	1
Urban-I 3.0	86864 1	titan	matt	300	L	56 - 61	1
Urban-I 3.0	86865 8	titan	matt	325	XL	61 - 65	1
Urban-I 3.0	40192 3	street art	matt+shiny	250	S	51 - 55	1
Urban-I 3.0	40193 0	street art	matt+shiny	280	M	52 - 58	1
Urban-I 3.0	40194 7	street art	matt+shiny	300	L	56 - 61	1
Urban-I 3.0	40195 4	street art	matt+shiny	325	XL	61 - 65	1
Urban-I 3.0	86858 0	polar white	matt	250	S	51 - 55	1
Urban-I 3.0	86859 7	polar white	matt	280	M	52 - 58	1
Urban-I 3.0	86860 3	polar white	matt	300	L	56 - 61	1
Urban-I 3.0	86861 0	polar white	matt	325	XL	61 - 65	1
Urban-I 3.0	86897 9	living coral	matt	250	S	51 - 55	1
Urban-I 3.0	86898 6	living coral	matt	280	M	52 - 58	1
Urban-I 3.0	88639 3	living coral	matt	300	L	56 - 61	1
Urban-I 3.0	86891 7	jade green	matt	250	S	51 - 55	1
Urban-I 3.0	86892 4	jade green	matt	280	M	52 - 58	1
Urban-I 3.0	86893 1	jade green	matt	300	L	56 - 61	1
Urban-I 3.0	86894 8	glacier blue	matt	250	S	51 - 55	1
Urban-I 3.0	86895 5	glacier blue	matt	280	M	52 - 58	1
Urban-I 3.0	86896 2	glacier blue	matt	300	L	56 - 61	1
Urban-I 3.0	40190 9	flower art	matt+shiny	250	S	51 - 55	1
Urban-I 3.0	40191 6	flower art	matt+shiny	280	M	52 - 58	1
Urban-I 3.0	64214 2	flower art	matt+shiny	300	L	56 - 61	1
Urban-I 3.0	86882 5	core green	matt	250	S	51 - 55	1
Urban-I 3.0	86883 2	core green	matt	280	M	52 - 58	1
Urban-I 3.0	86884 9	core green	matt	300	L	56 - 61	1
Urban-I 3.0	86885 6	core green	matt	325	XL	61 - 65	1
Urban-I 3.0	86878 8	core blue	matt	250	S	51 - 55	1
Urban-I 3.0	86879 5	core blue	matt	280	M	52 - 58	1
Urban-I 3.0	86880 1	core blue	matt	300	L	56 - 61	1
Urban-I 3.0	86881 8	core blue	matt	325	XL	61 - 65	1
Urban-I 3.0	86866 5	signal yellow	shiny	250	S	51 - 55	1
Urban-I 3.0	86867 2	signal yellow	shiny	280	M	52 - 58	1
Urban-I 3.0	86868 9	signal yellow	shiny	300	L	56 - 61	1
Urban-I 3.0	86869 6	signal yellow	shiny	325	XL	61 - 65	1
Urban-I 3.0	86874 0	signal silver	shiny	250	S	51 - 55	1
Urban-I 3.0	86875 7	signal silver	shiny	280	M	52 - 58	1
Urban-I 3.0	86876 4	signal silver	shiny	300	L	56 - 61	1
Urban-I 3.0	86877 1	signal silver	shiny	325	XL	61 - 65	1
Urban-I 3.0	86870 2	signal orange	shiny	250	S	51 - 55	1
Urban-I 3.0	86871 9	signal orange	shiny	280	M	52 - 58	1
Urban-I 3.0	86872 6	signal orange	shiny	300	L	56 - 61	1
Urban-I 3.0	86873 3	signal orange	shiny	325	XL	61 - 65	1
Urban-I 3.0 MIPS	89184 7	velvet black	matt	270	S	51 - 55	1
Urban-I 3.0 MIPS	89183 0	velvet black	matt	300	M	52 - 58	1
Urban-I 3.0 MIPS	89182 3	velvet black	matt	320	L	56 - 61	1
Urban-I 3.0 MIPS	89181 6	velvet black	matt	345	XL	61 - 65	1
Urban-I 3.0 MIPS	89187 8	titan	matt	270	S	51 - 55	1
Urban-I 3.0 MIPS	89186 1	titan	matt	300	M	52 - 58	1
Urban-I 3.0 MIPS	89185 4	titan	matt	320	L	56 - 61	1
Urban-I 3.0 MIPS	89188 5	titan	matt	345	XL	61 - 65	1
Urban-I 3.0 MIPS	89191 5	signal yellow	shiny	270	S	51 - 55	1
Urban-I 3.0 MIPS	89190 8	signal yellow	shiny	300	M	52 - 58	1
Urban-I 3.0 MIPS	89189 2	signal yellow	shiny	320	L	56 - 61	1
Urban-I 3.0 MIPS	89192 2	signal yellow	shiny	345	XL	61 - 65	1

PURL-Y ACE

VIEWS



midnight blue



midnight blue



FEATURES



Zoom Ace Urban



Buckle



Magnetic USB tail light

ACCESSORIES

- ABUS Bag
- USB-light

TECHNOLOGY



VERSIONS



velvet black



titan



polar white



metallic copper



moss green



champagne gold



iced blue



signal yellow

Ref. No.	EAN 4003318	Colour	Finish	Weight g	Size	Head Size cm	Box Qty
PURL-Y ACE	97904 0	velvet black	matt+shiny	320	S	51 - 55	1
PURL-Y ACE	97905 7	velvet black	matt+shiny	340	M	54 - 58	1
PURL-Y ACE	97906 4	velvet black	matt+shiny	360	L	57 - 61	1
PURL-Y ACE	97907 1	titan	matt+shiny	320	S	51 - 55	1
PURL-Y ACE	97908 8	titan	matt+shiny	340	M	54 - 58	1
PURL-Y ACE	97909 5	titan	matt+shiny	360	L	57 - 61	1
PURL-Y ACE	97910 1	polar white	matt+shiny	320	S	51 - 55	1
PURL-Y ACE	97912 5	polar white	matt+shiny	340	M	54 - 58	1
PURL-Y ACE	97913 2	polar white	matt+shiny	360	L	57 - 61	1
PURL-Y ACE	97914 9	metallic copper	matt+shiny	320	S	51 - 55	1
PURL-Y ACE	97915 6	metallic copper	matt+shiny	340	M	54 - 58	1
PURL-Y ACE	97916 3	metallic copper	matt+shiny	360	L	57 - 61	1
PURL-Y ACE	97917 0	midnight bue	matt+shiny	320	S	51 - 55	1
PURL-Y ACE	97918 7	midnight bue	matt+shiny	340	M	54 - 58	1
PURL-Y ACE	97919 4	midnight bue	matt+shiny	360	L	57 - 61	1
PURL-Y ACE	97920 0	moss green	matt+shiny	320	S	51 - 55	1
PURL-Y ACE	97921 7	moss green	matt+shiny	340	M	54 - 58	1
PURL-Y ACE	97922 4	moss green	matt+shiny	360	L	57 - 61	1
PURL-Y ACE	97926 2	champagne gold	matt+shiny	320	S	51 - 55	1
PURL-Y ACE	97927 9	champagne gold	matt+shiny	340	M	54 - 58	1
PURL-Y ACE	97928 6	champagne gold	matt+shiny	360	L	57 - 61	1
PURL-Y ACE	97923 1	iced blue	matt+shiny	320	S	51 - 55	1
PURL-Y ACE	97924 8	iced blue	matt+shiny	340	M	54 - 58	1
PURL-Y ACE	97925 5	iced blue	matt+shiny	360	L	57 - 61	1
PURL-Y ACE	97929 3	signal yellow	matt+shiny	320	S	51 - 55	1
PURL-Y ACE	97930 9	signal yellow	matt+shiny	340	M	54 - 58	1
PURL-Y ACE	97931 6	signal yellow	matt+shiny	360	L	57 - 61	1

Urban



PURL-Y

VIEWS



moss green



moss green



FEATURES



Zoom Ace



Buckle



Magnetic USB tail light (optional)

ACCESSORIES

- ABUS Bag
- Spare light USB HUD-Y/PURL-Y

TECHNOLOGY



VERSIONS



shiny black

titan

shiny white

metallic copper

midnight blue

champagne gold

iced blue



signal yellow

Ref. No.	EAN 4003318	Colour	Finish	Weight g	Size	Head Size cm	Box Qty
PURL-Y	97850 0	shiny black	shiny	300	S	51 - 55	1
PURL-Y	97878 4	shiny black	shiny	320	M	54 - 58	1
PURL-Y	97879 1	shiny black	shiny	340	L	57 - 61	1
PURL-Y	97880 7	titan	shiny	300	S	51 - 55	1
PURL-Y	97881 4	titan	shiny	320	M	54 - 58	1
PURL-Y	97882 1	titan	shiny	340	L	57 - 61	1
PURL-Y	97883 8	shiny white	shiny	300	S	51 - 55	1
PURL-Y	97884 5	shiny white	shiny	320	M	54 - 58	1
PURL-Y	97885 2	shiny white	shiny	340	L	57 - 61	1
PURL-Y	97886 9	metallic copper	shiny	300	S	51 - 55	1
PURL-Y	97887 6	metallic copper	shiny	320	M	54 - 58	1
PURL-Y	97888 3	metallic copper	shiny	340	L	57 - 61	1
PURL-Y	97889 0	midnight blue	shiny	300	S	51 - 55	1
PURL-Y	97890 6	midnight blue	shiny	320	M	54 - 58	1
PURL-Y	97891 3	midnight blue	shiny	340	L	57 - 61	1
PURL-Y	97892 0	moss green	shiny	300	S	51 - 55	1
PURL-Y	97893 7	moss green	shiny	320	M	54 - 58	1
PURL-Y	97894 4	moss green	shiny	340	L	57 - 61	1
PURL-Y	97898 2	champagne gold	shiny	300	S	51 - 55	1
PURL-Y	97899 9	champagne gold	shiny	320	M	54 - 58	1
PURL-Y	97900 2	champagne gold	shiny	340	L	57 - 61	1
PURL-Y	97895 1	iced blue	shiny	300	S	51 - 55	1
PURL-Y	97896 8	iced blue	shiny	320	M	54 - 58	1
PURL-Y	97897 5	iced blue	shiny	340	L	57 - 61	1
PURL-Y	97901 9	signal yellow	shiny	300	S	51 - 55	1
PURL-Y	97902 6	signal yellow	shiny	320	M	54 - 58	1
PURL-Y	97903 3	signal yellow	shiny	340	L	57 - 61	1

Urban



HYBAN 2.0 LED

VIEWS



signal black



signal black



FEATURES



Zoom Ace Urban



Buckle



USB LED 360

ACCESSORIES

- ABUS Bag
- Raincap Toplight

TECHNOLOGY



VERSIONS



signal yellow



signal silver



signal glacier

Ref. No.	EAN 4003318	Colour	Finish	Weight g	Size	Head Size cm	Box Qty
Hyban 2.0 LED	61461 3	signal yellow	shiny	400	M	52 - 58	1
Hyban 2.0 LED	61462 0	signal yellow	shiny	455	L	56 - 61	1
Hyban 2.0 LED	61463 7	signal yellow	shiny	500	XL	58 - 63	1
Hyban 2.0 LED	61464 4	signal silver	shiny	400	M	52 - 58	1
Hyban 2.0 LED	61465 1	signal silver	shiny	455	L	56 - 61	1
Hyban 2.0 LED	61466 8	signal silver	shiny	500	XL	58 - 63	1
Hyban 2.0 LED	66711 4	signal glacier	matt	400	M	52 - 58	1
Hyban 2.0 LED	66712 1	signal glacier	matt	455	L	56 - 61	1
Hyban 2.0 LED	66713 8	signal glacier	matt	500	XL	58 - 63	1
Hyban 2.0 LED	61458 3	signal black	matt	400	M	52 - 58	1
Hyban 2.0 LED	61459 0	signal black	matt	455	L	56 - 61	1
Hyban 2.0 LED	61460 6	signal black	matt	500	XL	58 - 63	1



Urban

HYBAN 2.0 ACE

VIEWS



titan



titan



FEATURES



Zoom Ace Urban



Fidlock



LED

ACCESSORIES

- ABUS Bag
- Visor smoke
Pedelec 2.0,
Hyban 2.0, HUD-Y

TECHNOLOGY



VERSIONS



velvet black



signal yellow



polar white

Ref. No.	EAN 4003318	Colour	Finish	Weight g	Size	Head size cm	Box Qty
Hyban 2.0 ACE	86934 1	velvet black	matt	470	M	52 - 58	1
Hyban 2.0 ACE	86935 8	velvet black	matt	510	L	56 - 61	1
Hyban 2.0 ACE	86936 5	velvet black	matt	560	XL	58 - 63	1
Hyban 2.0 ACE	86937 2	titan	matt	470	M	52 - 58	1
Hyban 2.0 ACE	86938 9	titan	matt	510	L	56 - 61	1
Hyban 2.0 ACE	86939 6	titan	matt	560	XL	58 - 63	1
Hyban 2.0 ACE	86940 2	signal yellow	shiny	470	M	52 - 58	1
Hyban 2.0 ACE	86941 9	signal yellow	shiny	510	L	56 - 61	1
Hyban 2.0 ACE	86997 6	polar white	shiny	470	M	52 - 58	1
Hyban 2.0 ACE	86998 3	polar white	shiny	510	L	56 - 61	1
Glas Accessories	82888 1	smoke			universal		1
Glas Accessories	82889 8	clear			universal		1



HYBAN 2.0

VIEWS



chrome silver



chrome silver



FEATURES



Zoom Ace Urban



Buckle



LED

ACCESSORIES

- ABUS Bag
- LED light

TECHNOLOGY



VERSIONS



velvet black



titan



polar white



living coral



jade green



glacier blue



core green



core blue



chrome rosé



signal orange



signal silver



signal yellow



velvet black



titan



signal yellow

Ref. No.	EAN 4003318	Colour	Finish	Weight g	Size	Head size cm	Box Qty
Hyban 2.0	86899 3	velvet black	matt	400	M	52 - 58	1
Hyban 2.0	86900 6	velvet black	matt	460	L	56 - 61	1
Hyban 2.0	86901 3	velvet black	matt	500	XL	58 - 63	1
Hyban 2.0	86905 1	titan	matt	400	M	52 - 58	1
Hyban 2.0	86906 8	titan	matt	460	L	56 - 61	1
Hyban 2.0	86907 5	titan	matt	500	XL	58 - 63	1
Hyban 2.0	86902 0	polar white	shiny	400	M	52 - 58	1
Hyban 2.0	86903 7	polar white	shiny	460	L	56 - 61	1
Hyban 2.0	86904 4	polar white	shiny	500	XL	58 - 63	1
Hyban 2.0	86932 7	living coral	shiny	400	M	52 - 58	1
Hyban 2.0	86926 6	jade green	shiny	400	M	52 - 58	1
Hyban 2.0	86927 3	jade green	shiny	460	L	56 - 61	1
Hyban 2.0	86929 7	glacier blue	shiny	400	M	52 - 58	1
Hyban 2.0	86930 3	glacier blue	shiny	460	L	56 - 61	1
Hyban 2.0	86920 4	core green	shiny	400	M	52 - 58	1
Hyban 2.0	86921 1	core green	shiny	460	L	56 - 61	1
Hyban 2.0	86917 4	core blue	shiny	400	M	52 - 58	1
Hyban 2.0	86918 1	core blue	shiny	460	L	56 - 61	1
Hyban 2.0	40184 8	chrome silver	shiny	400	M	52 - 58	1
Hyban 2.0	40197 8	chrome silver	shiny	460	L	56 - 61	1
Hyban 2.0	40185 5	chrome rosé	shiny	400	M	52 - 58	1
Hyban 2.0	86911 2	signal orange	shiny	400	M	52 - 58	1
Hyban 2.0	86912 9	signal orange	shiny	460	L	56 - 61	1
Hyban 2.0	86914 3	signal silver	shiny	400	M	52 - 58	1
Hyban 2.0	86915 0	signal silver	shiny	460	L	56 - 61	1
Hyban 2.0	86916 7	signal silver	shiny	480	XL	58 - 63	1
Hyban 2.0	86908 2	signal yellow	shiny	400	M	52 - 58	1
Hyban 2.0	86909 9	signal yellow	shiny	460	L	56 - 61	1
Hyban 2.0 MIPS	89200 4	velvet black	matt	420	M	52 - 58	1
Hyban 2.0 MIPS	89199 1	velvet black	matt	480	L	56 - 61	1
Hyban 2.0 MIPS	89201 1	velvet black	matt	500	XL	58 - 63	1
Hyban 2.0 MIPS	89203 5	titan	matt	420	M	52 - 58	1
Hyban 2.0 MIPS	89202 8	titan	matt	480	L	56 - 61	1
Hyban 2.0 MIPS	89204 2	titan	matt	500	XL	58 - 63	1
Hyban 2.0 MIPS	89206 6	signal yellow	shiny	420	M	52 - 58	1
Hyban 2.0 MIPS	89205 9	signal yellow	shiny	480	L	56 - 61	1
Hyban 2.0 MIPS	89207 3	signal yellow	shiny	500	XL	58 - 63	1

Urban



SKURB ACE

VIEWS



goldfish orange



goldfish orange



FEATURES



Zoom Ace MTB



Buckle



TECHNOLOGY



VERSIONS



moss green



velvet black



silver white



glacier blue



city vibes

Ref. No.	EAN 4003318	Colour	Finish	Weight g	Size	Head size cm	Box Qty
Skurb Ace	97963 7	goldfish orange	shiny	300	S	52 - 56	1
Skurb Ace	97964 4	goldfish orange	shiny	310	M	55 - 59	1
Skurb Ace	97965 1	goldfish orange	shiny	340	L	58 - 61	1
Skurb Ace	97967 5	moss green	shiny	300	S	52 - 56	1
Skurb Ace	97968 2	moss green	shiny	310	M	55 - 59	1
Skurb Ace	97969 9	moss green	shiny	340	L	58 - 61	1
Skurb ACE	40385 9	velvet black	matt+shiny	310	S	52 - 56	1
Skurb ACE	40386 6	velvet black	matt+shiny	320	M	55 - 59	1
Skurb ACE	40387 3	velvet black	matt+shiny	340	L	58 - 61	1
Skurb ACE	40394 1	silver white	matt+shiny	310	S	52 - 56	1
Skurb ACE	40395 8	silver white	matt+shiny	320	M	55 - 59	1
Skurb ACE	40396 5	silver white	matt+shiny	340	L	58 - 61	1
Skurb ACE	40388 0	glacier blue	matt+shiny	310	S	52 - 56	1
Skurb ACE	40389 7	glacier blue	matt+shiny	320	M	55 - 59	1
Skurb ACE	40390 3	glacier blue	matt+shiny	340	L	58 - 61	1
Skurb ACE	96455 8	city vibes	shiny	300	S	52 - 56	1
Skurb ACE	96456 5	city vibes	shiny	310	M	55 - 59	1
Skurb ACE	96457 2	city vibes	shiny	340	L	58 - 61	1



SKURB

NEW

VIEWS



goldfish orange



goldfish orange



FEATURES



Zoom Ace MTB



Buckle

TECHNOLOGY



VERSIONS



moss green



velvet black



titan



pearl white



midnight blue



velvet black



pearl white



concrete grey

Ref. No.	EAN 4003318	Colour	Finish	Weight g	Size	Head size cm	Box Qty
Skurb	97957 6	goldfish orange	shiny	300	S	52 - 56	1
Skurb	97958 3	goldfish orange	shiny	310	M	55 - 59	1
Skurb	97959 0	goldfish orange	shiny	340	L	58 - 61	1
Skurb	97960 6	moss green	shiny	300	S	52 - 56	1
Skurb	97961 3	moss green	shiny	310	M	55 - 59	1
Skurb	97962 0	moss green	shiny	340	L	58 - 61	1
Skurb	40367 5	velvet black	matt	300	S	52 - 56	1
Skurb	40368 2	velvet black	matt	310	M	55 - 59	1
Skurb	40369 9	velvet black	matt	340	L	58 - 61	1
Skurb	40370 5	titan	matt	300	S	52 - 56	1
Skurb	40371 2	titan	matt	310	M	55 - 59	1
Skurb	40372 9	titan	matt	340	L	58 - 61	1
Skurb	40373 6	pearl white	shiny	300	S	52 - 56	1
Skurb	40374 3	pearl white	shiny	310	M	55 - 59	1
Skurb	40375 0	pearl white	shiny	340	L	58 - 61	1
Skurb	40376 7	midnight blue	shiny	300	S	52 - 56	1
Skurb	40377 4	midnight blue	shiny	310	M	55 - 59	1
Skurb	40378 1	midnight blue	shiny	340	L	58 - 61	1
Skurb MIPS	40627 0	velvet black	matt	360	S	52 - 56	1
Skurb MIPS	40628 7	velvet black	matt	380	M	55 - 59	1
Skurb MIPS	40629 4	velvet black	matt	410	L	58 - 61	1
Skurb MIPS	40624 9	polar white	matt	360	S	52 - 56	1
Skurb MIPS	40625 6	polar white	matt	380	M	55 - 59	1
Skurb MIPS	40626 3	polar white	matt	410	L	58 - 61	1
Skurb MIPS	40630 0	concrete grey	matt	360	S	52 - 56	1
Skurb MIPS	40631 7	concrete grey	matt	380	M	55 - 59	1
Skurb MIPS	40632 4	concrete grey	matt	410	L	58 - 61	1

Urban



SCRAPER 3.0 ACE

VIEWS



ultra blue



ultra blue



FEATURES



Zoom Ace Urban



Buckle

ACCESSORIES

- ABUS Bag
- Scraper 3.0 Winter kit

TECHNOLOGY



VERSIONS



velvet black



concrete grey

Ref. No.	EAN 4003318	Colour	Finish	Weight g	Size	Head size cm	Box Qty
Scraper 3.0 ACE	81770 0	velvet black	matt	460	M	54 - 58	1
Scraper 3.0 ACE	81771 7	velvet black	matt	510	L	57 - 61	1
Scraper 3.0 ACE	81774 8	ultra blue	matt	460	M	54 - 58	1
Scraper 3.0 ACE	81775 5	ultra blue	matt	510	L	57 - 61	1
Scraper 3.0 ACE	81772 4	concrete grey	matt	460	M	54 - 58	1
Scraper 3.0 ACE	81773 1	concrete grey	matt	510	L	57 - 61	1



SCRAPER 3.0

VIEWS



velvet black



velvet black



FEATURES



Zoom Ace Urban



Buckle

ACCESSORIES

- ABUS Bag
- Scraper 3.0 Winter kit

TECHNOLOGY



VERSIONS



concrete grey



ultra blue



signal orange



polar matt

Ref. No.	EAN 4003318	Colour	Finish	Weight g	Size	Head size cm	Box Qty
Scraper 3.0	81758 8	velvet black	matt	450	M	54 - 58	1
Scraper 3.0	81759 5	velvet black	matt	490	L	57 - 62	1
Scraper 3.0	81760 1	concrete grey	matt	450	M	54 - 58	1
Scraper 3.0	81761 8	concrete grey	matt	490	L	57 - 62	1
Scraper 3.0	81762 5	ultra blue	matt	450	M	54 - 58	1
Scraper 3.0	81763 2	ultra blue	matt	490	L	57 - 62	1
Scraper 3.0	81766 3	signal orange	matt	450	M	54 - 58	1
Scraper 3.0	81767 0	signal orange	matt	490	L	57 - 62	1
Scraper 3.0	81768 7	polar matt	matt	450	M	54 - 58	1
Scraper 3.0	81769 4	polar matt	matt	490	L	57 - 62	1



ADURO 3.0

VIEWS



purple waves



purple waves



FEATURES



Zoom Ace



Buckle



USB-light (optional)

ACCESSORIES

- ABUS Bag
- USB-light Aduro 3.0

TECHNOLOGY



VERSIONS



velvet black

polar white

midnight blue

titan

race black

glacier blue

blaze red



race grey

maori blackberry

white art

orange palm

signal yellow

Ref. No.	EAN 4003318	Colour	Finish	Weight g	Size	Head size cm	Box Qty
Aduro 3.0	90127 0	velvet black	matt	280	S	51 - 55	1
Aduro 3.0	90325 0	velvet black	matt	300	M	52 - 58	1
Aduro 3.0	90346 5	velvet black	matt	320	L	58 - 62	1
Aduro 3.0	90493 6	polar white	matt	280	S	51 - 55	1
Aduro 3.0	90628 2	polar white	matt	300	M	52 - 58	1
Aduro 3.0	90793 7	polar white	matt	320	L	58 - 62	1
Aduro 3.0	91265 8	midnight blue	shiny	280	S	51 - 55	1
Aduro 3.0	91268 9	midnight blue	shiny	300	M	52 - 58	1
Aduro 3.0	91269 6	midnight blue	shiny	320	L	58 - 62	1
Aduro 3.0	91270 2	titan	matt	280	S	51 - 55	1
Aduro 3.0	91273 3	titan	matt	300	M	52 - 58	1
Aduro 3.0	91277 1	titan	matt	320	L	58 - 62	1
Aduro 3.0	91280 1	race black	matt	280	S	51 - 55	1
Aduro 3.0	91281 8	race black	matt	300	M	52 - 58	1
Aduro 3.0	91282 5	race black	matt	320	L	58 - 62	1
Aduro 3.0	91285 6	glacier blue	shiny	280	S	51 - 55	1
Aduro 3.0	91311 2	glacier blue	shiny	300	M	52 - 58	1
Aduro 3.0	91380 8	glacier blue	shiny	320	L	58 - 62	1
Aduro 3.0	91381 5	blaze red	shiny	280	S	51 - 55	1
Aduro 3.0	91528 4	blaze red	shiny	300	M	52 - 58	1
Aduro 3.0	91715 8	blaze red	shiny	320	L	58 - 62	1
Aduro 3.0	91732 5	race grey	matt	280	S	51 - 55	1
Aduro 3.0	91733 2	race grey	matt	300	M	52 - 58	1
Aduro 3.0	91734 9	race grey	matt	320	L	58 - 62	1
Aduro 3.0	91735 6	maori blackberry	matt	280	S	51 - 55	1
Aduro 3.0	91736 3	maori blackberry	matt	300	M	52 - 58	1
Aduro 3.0	91737 0	maori blackberry	matt	320	L	58 - 62	1
Aduro 3.0	91738 7	white art	shiny	280	S	51 - 55	1
Aduro 3.0	91739 4	white art	shiny	300	M	52 - 58	1
Aduro 3.0	91740 0	white art	shiny	320	L	58 - 62	1
Aduro 3.0	02033 9	orange palm	shiny	280	S	51 - 55	1
Aduro 3.0	02044 5	orange palm	shiny	300	M	52 - 58	1
Aduro 3.0	02095 7	orange palm	shiny	320	L	58 - 62	1
Aduro 3.0	02098 8	purple waves	shiny	280	S	51 - 55	1
Aduro 3.0	02122 0	purple waves	shiny	300	M	52 - 58	1
Aduro 3.0	02123 7	purple waves	shiny	320	L	58 - 62	1
Aduro 3.0	02549 5	signal yellow	shiny	280	S	51 - 55	1
Aduro 3.0	02794 9	signal yellow	shiny	300	M	52 - 58	1
Aduro 3.0	02850 2	signal yellow	shiny	320	L	58 - 62	1

Urban



KIDS



YOUDROP FF



Ti silver

Page 242



moss green

Page 242



sage green

Page 242



velvet black

Page 242



midnight blue

Page 242



chalk grey

Page 242

YOUDROP



moss green

Page 244



Ti silver

Page 244



shiny black

Page 244



icon yellow

Page 244



sage green

Page 244



wildberry red

Page 244

YOUN-I 2.0



cool grey

Page 246



velvet black

Page 246



street art

Page 246



sparkling titan

Page 246



sparkling pink

Page 246



sparkling green

Page 246



sparkling blue

Page 246



signal yellow

Page 246



polar white

Page 246



living coral

Page 246



grey star

Page 246



grey flash

Page 246



glacier blue

Page 246



flower art

Page 246



cherry heart

Page 246



blue anchor

Page 246



blaze red

Page 246



black violett

Page 246



rose gold

Page 246



midnight blue

Page 246



iced mint

Page 246

YOUN-I MIPS



Mips

velvet black

Page 248



Mips

sparkling green

Page 248



Mips

polar matt

Page 248

SKURB KID



blue sailor

Page 250



green jungle

Page 250



rose foxes

Page 250



shiny pink

Page 250



shiny green

Page 250



shiny red

Page 250



midnight blue

Page 250



goldfish orange

Page 250



shiny black

Page 250



cream summer

Page 250



white crowns

Page 250



grey stars

Page 250

SMILEY 3.0 ACE LED



velvet black

Page 252



shiny white

Page 252



shiny grey

Page 252



royal purple

Page 252



royal green

Page 252



royal blue

Page 252

SMILEY 3.0 LED



blue car

Page 254



rose strawberry

Page 254



grey space

Page 254



blue rainbow

Page 254

SMILEY 3.0



pink butterfly

Page 256



shiny yellow

Page 256



shiny red

Page 256



shiny pink

Page 256



shiny orange

Page 256



shiny green

Page 256



shiny blue

Page 256



rose princess

Page 256



purple star

Page 256



orange monster

Page 256



grey police

Page 256



grey horse

Page 256



green robo

Page 256



green nordic

Page 256



blue whale

Page 256



blue croco

Page 256



blue space

Page 258



white smiley

Page 258



pink watermelon

Page 258



purple kisses

Page 258

SMOOTY 2.0

YOUDROP FF

VIEWS



Ti silver



Ti silver



FEATURES



Zoom Ace YouDrop



Velcro Visor



Chinguard Youdrop



Reflector

TECHNOLOGY



VERSIONS



moss green



sage green



velvet black



midnight blue



chalk grey

Ref. No.	EAN 4003318	Colour	Finish	Weight g	Size	Head size cm	Box Qty
YouDrop FF	98089 3	Ti silver	matt	440	S	48 - 55	1
YouDrop FF	98090 9	moss green	matt	440	S	48 - 55	1
YouDrop FF	03421 3	sage green	matt	430	S	48 - 55	1
YouDrop FF	03419 0	velvet black	matt	440	S	48 - 55	1
YouDrop FF	03420 6	midnight blue	matt	430	S	48 - 55	1
YouDrop FF	03422 0	chalk grey	matt	430	S	48 - 55	1



YOUDROP

VIEWS



moss green



moss green



FEATURES



Zoom Ace YouDrop



Reflector



Velcro Visor

ACCESSOIRES

- ABUS Bag



TECHNOLOGY



VERSIONS



Ti silver



shiny black



icon yellow



sage green



wildberry red

Ref. No.	EAN 4003318	Colour	Finish	Weight g	Size	Head size cm	Box Qty
YouDrop	98087 9	Ti silver	shiny	310	S	48 - 55	1
YouDrop	98088 6	moss green	shiny	310	S	48 - 55	1
YouDrop	03423 7	shiny black	shiny	310	S	48 - 55	1
YouDrop	03426 8	icon yellow	shiny	310	S	48 - 55	1
YouDrop	03431 2	sage green	shiny	310	S	48 - 55	1
YouDrop	03425 1	wildberry red	shiny	310	S	48 - 55	1



YOUN-I 2.0

VIEWS



cool grey



cool grey



FEATURES



Zoom Ace Urban



Buckle



LED



Test winner by German Consumers Association

ACCESSOIRES

- ABUS Bag
- USB light
URBAN-I 3.0/HYBAN
2.0/YOUN-I 2.0

TECHNOLOGY



VERSIONS



velvet black

street art

sparkling titan

sparkling pink

sparkling green

sparkling blue

signal yellow

pearl white

living coral

grey star

grey flash

glacier blue

flower art

cherry heart

blue anchor

blaze red

black violett

rose gold

midnight blue

iced mint

Ref. No.	EAN 4003318	Colour	Finish	Weight g	Size	Head size cm	Box Qty
Youn-I 2.0	40150 3	velvet black	matt	240	S	48 - 54	1
Youn-I 2.0	40151 0	velvet black	matt	260	M	52 - 57	1
Youn-I 2.0	67047 3	street art	matt+shiny	240	S	48 - 54	1
Youn-I 2.0	67048 0	street art	matt+shiny	260	M	52 - 57	1
Youn-I 2.0	40170 1	sparkling titan	shiny	240	S	48 - 54	1
Youn-I 2.0	40171 8	sparkling titan	shiny	260	M	52 - 57	1
Youn-I 2.0	40164 0	sparkling pink	shiny	240	S	48 - 54	1
Youn-I 2.0	40165 7	sparkling pink	shiny	260	M	52 - 57	1
Youn-I 2.0	40160 2	sparkling green	shiny	240	S	48 - 54	1
Youn-I 2.0	40161 9	sparkling green	shiny	260	M	52 - 57	1
Youn-I 2.0	40158 9	sparkling blue	shiny	240	S	48 - 54	1
Youn-I 2.0	40159 6	sparkling blue	shiny	260	M	52 - 57	1
Youn-I 2.0	40162 6	signal yellow	shiny	240	S	48 - 54	1
Youn-I 2.0	40163 3	signal yellow	shiny	260	M	52 - 57	1
Youn-I 2.0	40152 7	pearl white	shiny	240	S	48 - 54	1
Youn-I 2.0	40153 4	pearl white	shiny	260	M	52 - 57	1
Youn-I 2.0	40156 5	living coral	shiny	240	S	48 - 54	1
Youn-I 2.0	40157 2	living coral	shiny	260	M	52 - 57	1
Youn-I 2.0	63810 7	grey star	matt+shiny	240	S	48 - 54	1
Youn-I 2.0	63811 4	grey star	matt+shiny	260	M	52 - 57	1
Youn-I 2.0	91890 2	cool grey	matt	240	S	48 - 54	1
Youn-I 2.0	91891 9	cool grey	matt	260	M	52 - 57	1
Youn-I 2.0	63812 1	grey flash	matt+shiny	240	S	48 - 54	1
Youn-I 2.0	63813 8	grey flash	matt+shiny	260	M	52 - 57	1
Youn-I 2.0	40154 1	glacier blue	shiny	240	S	48 - 54	1
Youn-I 2.0	40155 8	glacier blue	shiny	260	M	52 - 57	1
Youn-I 2.0	67045 9	flower art	matt+shiny	240	S	48 - 54	1
Youn-I 2.0	67046 6	flower art	matt+shiny	260	M	52 - 57	1
Youn-I 2.0	63808 4	cherry heart	matt+shiny	240	S	48 - 54	1
Youn-I 2.0	63809 1	cherry heart	matt+shiny	260	M	52 - 57	1
Youn-I 2.0	63814 5	blue anchor	matt+shiny	240	S	48 - 54	1
Youn-I 2.0	63815 2	blue anchor	matt+shiny	260	M	52 - 57	1
Youn-I 2.0	40168 8	blaze red	shiny	240	S	48 - 54	1
Youn-I 2.0	40169 5	blaze red	shiny	260	M	52 - 57	1
Youn-I 2.0	40166 4	black violet	shiny	240	S	48 - 54	1
Youn-I 2.0	40167 1	black violet	shiny	260	M	52 - 57	1
Youn-I 2.0	91888 9	rose gold	matt	240	S	48 - 54	1
Youn-I 2.0	91889 6	rose gold	matt	260	M	52 - 57	1
Youn-I 2.0	91885 8	midnight blue	matt	240	S	48 - 54	1
Youn-I 2.0	91887 2	midnight blue	matt	260	M	52 - 57	1
Youn-I 2.0	91892 6	iced mint	matt	240	S	48 - 54	1
Youn-I 2.0	91893 3	iced mint	matt	260	M	52 - 57	1



YOUN-I MIPS

VERSIONS



velvet black



velvet black



FEATURES



Zoom Evo Kids



Buckle



LED

ACCESSOIRES

- ABUS Bag
- Raincap Toplight



TECHNOLOGY



VERSIONS



sparkling green



polar matt

Ref. No.	EAN 4003318	Colour	Finish	Weight g	Size	Head size cm	Box Qty
Youn-I MIPS	38811 8	velvet black	matt	260	S	48 - 54	1
Youn-I MIPS	38812 5	velvet black	matt	280	M	52 - 57	1
Youn-I MIPS	38813 2	sparkling green	shiny	260	S	48 - 54	1
Youn-I MIPS	38814 9	sparkling green	shiny	280	M	52 - 57	1
Youn-I MIPS	38809 5	polar matt	matt	260	S	48 - 54	1
Youn-I MIPS	38810 1	polar matt	matt	280	M	52 - 57	1



SKURB KID

NEW

VIEWS



blue sailor



blue sailor



FEATURES



Zoom Evo Kids



Buckle



USB LED top

ACCESSOIRES

- ABUS Bag
- Spare light USB Smiley 3.0/ Skurb Kid
- Spare light (Battery) Smiley 3.0/ Skurb Kid
- Winter Kit Child

TECHNOLOGY



VERSIONS



Ref. No.	EAN 4003318	Colour	Finish	Weight g	Size	Head size cm	Box Qty
Skurb Kid	97846 3	blue sailor	shiny	240	S	45 - 50	1
Skurb Kid	97847 0	blue sailor	shiny	250	M	50 - 55	1
Skurb Kid	97848 7	rose foxes	shiny	240	S	45 - 50	1
Skurb Kid	97849 4	rose foxes	shiny	250	M	50 - 55	1
Skurb Kid	04452 6	shiny pink	shiny	240	S	45 - 50	1
Skurb Kid	04650 6	shiny pink	shiny	250	M	50 - 55	1
Skurb Kid	04428 1	shiny green	shiny	240	S	45 - 50	1
Skurb Kid	04440 3	shiny green	shiny	250	M	50 - 55	1
Skurb Kid	04300 0	shiny red	shiny	240	S	45 - 50	1
Skurb Kid	04426 7	shiny red	shiny	250	M	50 - 55	1
Skurb Kid	04283 6	midnight blue	shiny	240	S	45 - 50	1
Skurb Kid	04289 8	midnight blue	shiny	250	M	50 - 55	1
Skurb Kid	04677 3	goldfish orange	shiny	240	S	45 - 50	1
Skurb Kid	04678 0	goldfish orange	shiny	250	M	50 - 55	1
Skurb Kid	04296 6	shiny black	shiny	240	S	45 - 50	1
Skurb Kid	04298 0	shiny black	shiny	250	M	50 - 55	1
Skurb Kid	04679 7	cream summer	shiny	240	S	45 - 50	1
Skurb Kid	04680 3	cream summer	shiny	250	M	50 - 55	1
Skurb Kid	04681 0	white crowns	shiny	240	S	45 - 50	1
Skurb Kid	04718 3	white crowns	shiny	250	M	50 - 55	1
Skurb Kid	04744 2	grey stars	shiny	240	S	45 - 50	1
Skurb Kid	04746 6	grey stars	shiny	250	M	50 - 55	1
Skurb Kid	04772 5	green jungle	shiny	240	S	45 - 50	1
Skurb Kid	04774 9	green jungle	shiny	250	M	50 - 55	1



SMILEY 3.0 ACE LED

VIEWS



velvet black



velvet black



FEATURES



Zoom Evo Kids



Buckle



USB LED

ACCESSOIRES

- ABUS Bag
- Winter Kit Child

TECHNOLOGY



VERSIONS



shiny white



shiny grey



royal purple



royal green



royal blue

Ref. No.	EAN 4003318	Colour	Finish	Weight g	Size	Head size cm	Box Qty
Smiley 3.0 ACE LED	67714 4	shiny white	shiny	230	S	45 - 50	1
Smiley 3.0 ACE LED	67715 1	shiny white	shiny	250	M	50 - 55	1
Smiley 3.0 ACE LED	67716 8	shiny grey	shiny	230	S	45 - 50	1
Smiley 3.0 ACE LED	67717 5	shiny grey	shiny	250	M	50 - 55	1
Smiley 3.0 ACE LED	67712 0	royal purple	shiny	230	S	45 - 50	1
Smiley 3.0 ACE LED	67713 7	royal purple	shiny	250	M	50 - 55	1
Smiley 3.0 ACE LED	67710 6	royal green	shiny	230	S	45 - 50	1
Smiley 3.0 ACE LED	67711 3	royal green	shiny	250	M	50 - 55	1
Smiley 3.0 ACE LED	67708 3	royal blue	shiny	230	S	45 - 50	1
Smiley 3.0 ACE LED	67709 0	royal blue	shiny	250	M	50 - 55	1
Smiley 3.0 ACE LED	66228 7	velvet black	matt	230	S	45 - 50	1
Smiley 3.0 ACE LED	66239 3	velvet black	matt	250	M	50 - 55	1



SMILEY 3.0 LED

VIEWS



blue car



blue car



FEATURES



Zoom Evo Kids



Buckle



USB LED top

ACCESSOIRES

- ABUS Bag
- Spare light USB Smiley 3.0/ Skurb Kid
- Winter Kit Child

TECHNOLOGY



VERSIONS



rose strawberry



grey space



blue rainbow

Ref. No.	EAN 4003318	Colour	Finish	Weight g	Size	Head size cm	Box Qty
Smiley 3.0 LED	67706 9	rose strawberry	shiny	230	S	45 - 50	1
Smiley 3.0 LED	67707 6	rose strawberry	shiny	250	M	50 - 55	1
Smiley 3.0 LED	67298 9	grey space	shiny	230	S	45 - 50	1
Smiley 3.0 LED	67299 6	grey space	shiny	250	M	50 - 55	1
Smiley 3.0 LED	67300 9	blue rainbow	shiny	230	S	45 - 50	1
Smiley 3.0 LED	67301 6	blue rainbow	shiny	250	M	50 - 55	1
Smiley 3.0 LED	67296 5	blue car	shiny	230	S	45 - 50	1
Smiley 3.0 LED	67297 2	blue car	shiny	250	M	50 - 55	1



SMILEY 3.0

VIEWS



pink butterfly



pink butterfly



FEATURES



Zoom Evo Kids



Buckle

ACCESSOIRES

- ABUS Bag
- Spare light USB Smiley 3.0/ Skurb Kid
- Spare light (Battery) Smiley 3.0/ Skurb Kid
- Winter Kit Child

TECHNOLOGY



VERSIONS



shiny yellow



shiny red



shiny pink



shiny orange



shiny green



shiny blue



rose princess



purple star



orange monster



grey police



grey horse



green robo



green nordic



blue whale



blue croco

Ref. No.	EAN 4003318	Colour	Finish	Weight g	Size	Head size cm	Box Qty
Smiley 3.0	67277 4	shiny yellow	shiny	220	S	45 - 50	1
Smiley 3.0	67278 1	shiny yellow	shiny	240	M	50 - 55	1
Smiley 3.0	67273 6	shiny red	shiny	220	S	45 - 50	1
Smiley 3.0	67274 3	shiny red	shiny	240	M	50 - 55	1
Smiley 3.0	67271 2	shiny pink	shiny	220	S	45 - 50	1
Smiley 3.0	67272 9	shiny pink	shiny	240	M	50 - 55	1
Smiley 3.0	67275 0	shiny orange	shiny	220	S	45 - 50	1
Smiley 3.0	67276 7	shiny orange	shiny	240	M	50 - 55	1
Smiley 3.0	67279 8	shiny green	shiny	220	S	45 - 50	1
Smiley 3.0	67280 4	shiny green	shiny	240	M	50 - 55	1
Smiley 3.0	67294 1	shiny blue	shiny	220	S	45 - 50	1
Smiley 3.0	67295 8	shiny blue	shiny	240	M	50 - 55	1
Smiley 3.0	67250 7	rose princess	shiny	220	S	45 - 50	1
Smiley 3.0	67251 4	rose princess	shiny	240	M	50 - 55	1
Smiley 3.0	67259 0	purple star	shiny	220	S	45 - 50	1
Smiley 3.0	67260 6	purple star	shiny	240	M	50 - 55	1
Smiley 3.0	67257 6	pink butterfly	shiny	220	S	45 - 50	1
Smiley 3.0	67258 3	pink butterfly	shiny	240	M	50 - 55	1
Smiley 3.0	67265 1	orange monster	shiny	220	S	45 - 50	1
Smiley 3.0	67266 8	orange monster	shiny	240	M	50 - 55	1
Smiley 3.0	67269 9	grey police	shiny	220	S	45 - 50	1
Smiley 3.0	67270 5	grey police	shiny	240	M	50 - 55	1
Smiley 3.0	67252 1	grey horse	shiny	220	S	45 - 50	1
Smiley 3.0	67253 8	grey horse	shiny	240	M	50 - 55	1
Smiley 3.0	67267 5	green robo	shiny	220	S	45 - 50	1
Smiley 3.0	67268 2	green robo	shiny	240	M	50 - 55	1
Smiley 3.0	67255 2	green nordic	shiny	220	S	45 - 50	1
Smiley 3.0	67256 9	green nordic	shiny	240	M	50 - 55	1
Smiley 3.0	67261 3	blue whale	shiny	220	S	45 - 50	1
Smiley 3.0	67262 0	blue whale	shiny	240	M	50 - 55	1
Smiley 3.0	67263 7	blue croco	shiny	220	S	45 - 50	1
Smiley 3.0	67264 4	blue croco	shiny	240	M	50 - 55	1



SMOOTY 2.0

VIEWS



blue space



blue space



FEATURES



Zoom Evo Kids



Buckle

ACCESSOIRES

- ABUS Bag

TECHNOLOGY



VERSIONS



white smiley



pink watermelon



purple kisses

Ref. No.	EAN 4003318	Colour	Finish	Weight g	Size	Head size cm	Box Qty
Smooty 2.0	81623 9	blue space	shiny	200	S	45 - 50	1
Smooty 2.0	81851 6	blue space	shiny	220	M	50 - 55	1
Smooty 2.0	81852 3	white smiley	shiny	200	S	45 - 50	1
Smooty 2.0	81853 0	white smiley	shiny	220	M	50 - 55	1
Smooty 2.0	81854 7	pink watermelon	shiny	200	S	45 - 50	1
Smooty 2.0	81855 4	pink watermelon	shiny	220	M	50 - 55	1
Smooty 2.0	81856 1	purple kisses	shiny	200	S	45 - 50	1
Smooty 2.0	81857 8	purple kisses	shiny	220	M	50 - 55	1



HELMET ACCESSORIES



**SCRAPER 3.0
WINTERKIT**



Page 262

RACE CAP



Page 263

SPARE SHIELD



Gamechanger
TT & TRI
Page 264

SPARE GLASS



Buteo
Page 265

USB- LIGHT ACCESSORIES



Urban-I 3.0, Hyban
2.0, Youn-I 2.0
Page 266

QUIN SENSOR



Page 267

**PEDELEC 2.0
EARPADS**



Page 262

RAIN CAP



Page 263

SPARE SHIELD



Hyban+
Page 264

USB- LIGHT ACCESSORIES



Hud-Y
Page 265

USB- LIGHT



Aduro 3.0
Page 266

ABUS BAG



Page 267

**HELMET BAG
SPORTIV**



Page 267

WINTERKIT



Page 262

RAIN CAP TOPLIGHT



Page 263

SPARE SHIELD



Pedelec 2.0, Hyban
2.0, Hud-Y Ace
Page 264

USB- LIGHT



Smiley 3.0,
Skurb Kid
Page 265

**PAD FRESH MS
CLEANING SPRAY**



Page 266

**REFLEKTOR
STICKERSET**

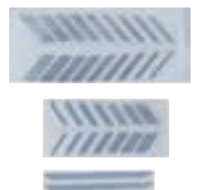

Urban-I 3.0,
Hyban 2.0
Page 267

SCRAPER 3.0 WINTERKIT



Winter kit consisting of EarPads, Vent Cover and fleece cap

TECHNICAL DATA

- Additional warming earmuffs which can be attached to the helmet

Ref. No.	EAN 4003318	Colour	Size	Box Qty
Scraper 3.0 Winter Kit	81804 2	velvet black	M	1
Scraper 3.0 Winter Kit	81806 6	polar matt	M	1
Scraper 3.0 Winter Kit	81808 0	ultra blue	M	1
Scraper 3.0 Winter Kit	81810 3	signal orange	M	1

PEDELEC 2.0 EARPADS



TECHNICAL DATA

- Additional warming earmuffs which can be attached to the helmet

Ref. No.	EAN 4003318	Colour	Size	Box Qty
Earpads Pedelec 2.0 black	83482 0	black	universal	1

WINTER KIT



TECHNICAL DATA

- Flexible and comfortable fleece bonnet with ear protection
- Seam welded for comfortable fit

Ref. No.	EAN 4003318	Colour	Size	Box Qty
Winter Kit	48876 4	black	M	1
Winter Kit Child	48874 0	black	S	1

RACE CAP



autumn noir



porto blue



italian white



adventure blue

TECHNICAL DATA

- Stylish racing cap to wear under the road bike helmet serves as protection from sun and sweat
- 100% Made in Italy
- Large antibacterial sweatband (20 mm diameter) sewn into the Race Cap
- Elastic waistband for custom fit
- Quick-drying blended fabric made from 65% polyester and 35% cotton
- Washable at 30 degrees, not suitable for tumble dryer
- 100% polyester mesh panel in the middle
- Size S / 51-55 cm
- Size M/L / 56-61 cm

Ref. No.	EAN 4003318	design color	Size	Head size cm	Box Qty
Race Cap	96907 2	autumn black	S	51 - 55	1
Race Cap	96047 5	autumn black	M/L	56 - 61	1
Race Cap	96909 6	porto blue	S	51 - 55	1
Race Cap	96048 2	porto blue	M/L	56 - 61	1
Race Cap	96908 9	italian white	S	51 - 55	1
Race Cap	96049 9	italian white	M/L	56 - 61	1
Race Cap	96906 5	adventure blue	S	51 - 55	1
Race Cap	96046 8	adventure blue	M/L	56 - 61	1

RAIN CAP



TECHNICAL DATA

- Elastic band for individual adjustment of the cap to the helmet size
- Universal rain cap in signal yellow colour. Shape optimised for a number of helmets, with visor in particular

Ref. No.	EAN 4003318	Colour	Size	Box Qty
Raincap	52151 5	yellow	universal	1
Raincap	52154 6	black	universal	1

RAIN CAP TOPLIGHT

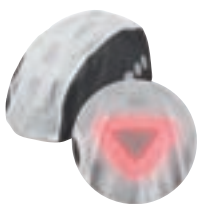

TECHNICAL DATA

- Elastic band for individual adjustment of the cap to the helmet size
- Rain cap Toplight is optimized for all helmets with a high LED rear light
- Due to the transparent material the LED rear light is clearly visible

Ref. No.	EAN 4003318	Colour	Size	Box Qty
Raincap Toplight	39849 0	black	universal	1

VISOR GAMECHANGER TT/TRI



transparente

Smoke

chrome

TECHNICAL DATA

- Anti-fog visor thanks to good ventilation and thus always clear view
- Magnets in the helmet and on the visor frame allow a firm grip but still easy removal of the visor
- The large visor allows a clear view to the front, even with strongly tilted helmet position
- Visor available in three versions
- Due to the design of the visor it fits well into the helmet and brings advantages in aerodynamics

Ref. No.	EAN 4003318	Colour	Size	Box Qty
Spare visor clear	67936 0	clear	S	1
Spare visor clear	67937 7	clear	M	1
Spare visor clear	67938 4	clear	L	1
Spare visor smoke	67939 1	smoke	S	1
Spare visor smoke	67940 7	smoke	M	1
Spare visor smoke	67941 4	smoke	L	1
Spare visor chrome	67942 1	chrome	S	1
Spare visor chrome	67943 8	chrome	M	1
Spare visor chrome	67944 5	chrome	L	1

REPLACEMENT HYBAN+ VISOR



Ref. No.	EAN 4003318	Colour	Size	Box Qty
Spare visor Hyban+	76435 6	smoke	universal	1
Spare visor Hyban+	76436 3	clear	universal	1
Visor Mount Hyban+	77325 9		universal	1

PEDELEC 2.0/HYBAN 2.0/HUD- Y ACE SPARE SHIELD



Ref. No.	EAN 4003318	Colour	Size	Box Qty
Visor smoke Pedelec 2.0, Hyban 2.0, HUD-Y	82888 1	smoke	universal	1
Visor clear Pedelec 2.0, Hyban 2.0, HUD-Y	82889 8	clear	universal	1
Fastening visor Pedelec 2.0, Hyban 2.0, HUD-Y	82890 4		universal	1

REPLACEMENT LENS BUTEO



TECHNICAL DATA

- Anti-fog coating
- Available with clear, mirror & tinted lens.

Ref. No.	EAN 4003318	Colour	Size	Box Qty
Spare glass Buteos	68934 5	clear	universal	1
Spare glass Buteos	68935 2	smoke	universal	1
Spare glass Buteos	68936 9	red chrome	universal	1
Spare glass Buteos	68937 6	black chrome	universal	1

LIGHT ACCESSORIES



TECHNICAL DATA

- USB rechargeable LED lights for Hud-y and Purl-y models
- Intuitive magnetic attachment to the helmet
- Three modes: continuous, flashing, pulse

Ref. No.	EAN 4003318	Colour	Size	Box Qty
Spare light USB HUD-Y/PURL-Y	69446 2			1

LIGHT ACCESSORIES



TECHNICAL DATA

- Rechargeable LED light for Smiley 3.0 and Skurb Kid helmet models
- Increases visibility in the dark and at dusk

Ref. No.	EAN 4003318	Colour	Size	Box Qty
Spare light (Battery) Smiley 3.0/ Skurb Kid	91108 8			1
Spare light USB Smiley 3.0/ Skurb Kid	69445 5			1

LIGHT ACCESSORIES



TECHNICAL DATA

- Rechargeable spare light for integration in various helmet model
- Increases visibility in the dark and at dusk

Ref. No.	EAN 4003318	Colour	Size	Box Qty
Spare light USB Urban-I 3.0 ACE	97625 4			1

USB LIGHT ADURO 3.0



TECHNICAL DATA

- Rechargeable USB light
- 2 modes: continuous and flashing light
- Rubberised button for switching on and off and switching between modes
- IP44 splash-protection
- Micro USB port with rubber cover (USB port cover) to protect against moisture and dirt
- Approx. 1 hour charging time, approx. 2.5 hours lighting time
- 8 LEDs
- Compatible with the Aduro 3.0

Ref. No.	EAN 4003318	Colour	Size	Box Qty
USB light Aduro 3.0	02939 4	Aduro 3.0		1

PAD FRESH MS CLEANING SPRAY



Ref. No.	EAN 4003318	Colour	Size	Box Qty
Pad Fresh MS Cleaning spray	79188 8		30ml	1

QUIN SENSOR

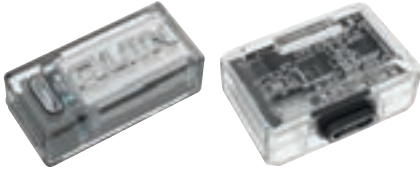

Capteur Quin / Slim

Capteur Quin

TECHNICAL DATA

- Crash sensor technology - five control sensors constantly evaluate data during use and detect dangerous situations
- IntelliSleep - if no movement is detected for five minutes, the chip automatically goes into sleep mode and saves energy
- Bluetooth 5.0 - guaranteed 20-metre wireless range to ensure a stable connection to the smartphone.
- Raise to wake - the QUIN helmet automatically pairs with the smartphone as soon as the QUIN chip detects movement.
- Rechargeable battery - four hours fast-charge mode via Micaro USB and up to one month battery life

Ref. No.	EAN 4003318	Colour	Size	Box Qty
Quin Sensor Slim	69319 9			1
Quin Sensor	68838 6			1

ABUS BAG



TECHNICAL DATA

- Helmet bag with logo print for the protected transport of a bicycle helmet
- Inside pocket is made from protective fleece

Ref. No.	EAN 4003318	Colour	Size	Box Qty
ABUS Bag	78592 4	black	universal	1

HELMET BAG SPORTIV



Ref. No.	EAN 4003318	Colour	Size	Box Qty
Helmet bag sportiv	68451 7	black	universal	1

REFLECTOR STICKERSET



Urban-I 3.0

Hyban 2.0

TECHNICAL DATA

- reflective sticker set for the helmet to improve visibility in the dark and at dusk

Ref. No.	EAN 4003318	Colour	Size	Box Qty
Reflector Stickerset Urban-I 3.0	88782 6	silver		1
Reflector Stickerset Hyban 2.0	88783 3	silver		1

LUMINO



**LUMINO
NIGHT VEST**



yellow

Page 270

**LUMINO
DAY VEST**



red

Page 270

URBAN VEST



silver

Page 271

REFLEX VEST



yellow

Page 271

URBAN VEST KIDS



silver

Page 272

REFLEX VEST KIDS



yellow

Page 272

NIGHT COVER



yellow

Page 274

X-URBAN COVER



yellow/silver

Page 274

REFLEX WRAP



yellow

Page 275

EASY MAGNET LIGHT



yellow

Page 276

INDICATOR LIGHT



yellow

Page 276

ACTIVE BAR



yellow/black

Page 277

RAINCAP



yellow

Page 277



black

Page 277

LUMINO NIGHT VEST

FEATURES



TECHNICAL DATA

- 100% polyester
- Silver applications light up as soon as light hits them
- UV-resistant material glows even after years of use
- Visibility of 150 metres at night and 100 metres during the day
- With integrated USB rear light consisting of four powerful red LEDs - rechargeable via USB port
- LED light shines for up to 10 hours (activate continuous and flashing light functions at the touch of a button)
- Additional pocket with zip on the front of the vest
- Tested according to European standard EN 1150:1999
- Extended back and good fit due to body fit

Ref. No.	EAN 4003318	Colour	Size	Box Qty
Lumino Night Vest yellow M	96020 8	yellow	M	1
Lumino Night Vest yellow L	96021 5	yellow	L	1
Lumino Night Vest yellow XL	96022 2	yellow	XL	1
Lumino Night Vest yellow XXL	96023 9	yellow	XXL	1
Lumino Night Vest yellow XXXL	96024 6	yellow	XXXL	1

LUMINO DAY VEST

FEATURES



TECHNICAL DATA

- 100% polyester
- Fluorescent red material lights up as soon as light hits it
- UV-resistant material glows even after years of use.
- Four highly reflective stripes for very good visibility at night, but also very good visibility during the day.
- Visibility of 150 metres at night and 100 metres during the day
- Tab on the back of the waistcoat to attach a separate light (Easy Magnet Light/Indicator Light)
- Tested according to European Standard EN 17353:2020 (AB3)
- Extended back and good fit

Ref. No.	EAN 4003318	Colour	Size	Box Qty
Lumino Day Vest red M	96026 0	red	M	1
Lumino Day Vest red L	96027 7	red	L	1
Lumino Day Vest red XL	96028 4	red	XL	1
Lumino Day Vest red XXL	96029 1	red	XXL	1
Lumino Day Vest red XXXL	96031 4	red	XXXL	1

LUMINO URBAN VEST

FEATURES



TECHNICAL DATA

- 100% polyester
- Fully reflective safety vest: Almost the entire surface of the safety vest is brightly illuminated by headlights.
- Colour coordinated stripes
- Visibility of 150 metres in the dark
- Tested according to European Standard EN 17353:2020 (B3)
- Tab on the back of the waistcoat to attach a separate light (Easy Magnet Light/Indicator Light)
- Extended back and good fit

Ref. No.	EAN 4003318	Colour	Size	Box Qty
Lumino Urban Vest silver M	69937 5	silver	M	1
Lumino Urban Vest silver L	69938 2	silver	L	1
Lumino Urban Vest silver XL	69944 3	silver	XL	1
Lumino Urban Vest silver XXL	90943 6	silver	XXL	1
Lumino Urban Vest silver XXXL	96034 5	silver	XXXL	1

LUMINO REFLEX VEST

FEATURES



TECHNICAL DATA

- 100% polyester
- Fluorescent yellow material lights up as soon as light hits it
- UV-resistant material glows even after years of use.
- Four highly reflective stripes for very good visibility at night, but also very good visibility during the day.
- Visibility of 150 metres at night and 100 metres during the day
- Tab on the back of the waistcoat to attach a separate light (Easy Magnet Light/Indicator Light)
- Tested according to European Standard EN 17353:2020 (AB3)
- Extended back and good fit

Ref. No.	EAN 4003318	Colour	Size	Box Qty
Lumino Reflex Vest yellow M	69928 3	yellow	M	1
Lumino Reflex Vest yellow L	69935 1	yellow	L	1
Lumino Reflex Vest yellow XL	69936 8	yellow	XL	1
Lumino Reflex Vest yellow XXL	90942 9	yellow	XXL	1
Lumino Reflex Vest yellow XXXL	96033 8	yellow	XXXL	1

LUMINO URBAN VEST KIDS

FEATURES

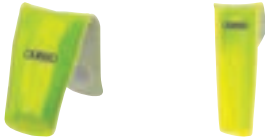

TECHNICAL DATA

- 100% polyester
- Fully reflective safety vest: Almost the entire surface of the safety vest is brightly illuminated by headlights.
- Colour coordinated stripes
- Visibility of 150 metres in the dark
- Tested according to European Standard EN 17353:2020 (B3)
- Excellent fit thanks to smooth-running branded zip

Ref. No.	EAN 4003318	Colour	Size	Box Qty
Lumino Urban Vest Kids silver S	69948 1	silver	S	1
Lumino Urban Vest Kids silver M	69949 8	silver	M	1
Lumino Urban Vest Kids silver L	69950 4	silver	L	1

LUMINO REFLEX VEST KIDS

FEATURES



TECHNICAL DATA

- 100% polyester
- Fluorescent yellow material lights up as soon as light hits it
- UV-resistant material glows even after years of use.
- Four highly reflective stripes for very good visibility at night, but also very good visibility during the day.
- Visibility of 150 metres at night and 100 metres during the day
- Excellent fit thanks to smooth-running branded zip
- Tested according to European Standard EN 17353:2020 (AB3)

Ref. No.	EAN 4003318	Colour	Size	Box Qty
Lumino Reflex Vest Kids yellow S	69945 0	yellow	S	1
Lumino Reflex Vest Kids yellow M	69946 7	yellow	M	1
Lumino Reflex Vest Kids yellow L	69947 4	yellow	L	1



LUMINO NIGHT COVER



TECHNICAL DATA

- Rain cover with integrated USB backlight - made of four powerful red LEDs
- Continuous and flashing light function at the touch of a button
- Rechargeable via USB port
- LED light shines for up to 10 hours (after charging)
- 2 adjustable elastic straps for fitting to the backpack
- Visibility of 150 metres at night and 100 metres during the day
- Good workmanship thanks to Welded seams
- Waterproof rain cover

Ref. No.	EAN	Colour	Box Qty
Lumino Night Cover yellow	4003318 69954 2	yellow	1

LUMINO X- URBAN COVER



TECHNICAL DATA

- Fluorescent yellow material lights up as soon as light hits it
- Highly reflective stripes for very good visibility at night, but also very good visibility during the day.
- Visibility of 150 metres at night and 100 metres during the day
- 2 adjustable elastic straps for fitting to the backpack
- Good workmanship thanks to Welded seams
- Waterproof rain cover

Ref. No.	EAN	Colour	Box Qty
Lumino X-Urban Cover yellow/silver	4003318 69955 9	yellow/silver	1

LUMINO REFLEX WRAP



TECHNICAL DATA

- Fluorescent yellow material lights up as soon as light hits it
- Two highly reflective stripes for very good visibility at night, but also very good visibility during the day.
- UV-resistant material (meets the requirements of the European standard EN2471) shines even after years of use.
- Visibility of 150 metres at night and 100 metres during the day
- Flexible thanks to Velcro fastener (from approx. 82 to 108 cm circumference)

Ref. No.	EAN	Colour	Box Qty
Lumino Reflex Wrap yellow	4003318 69952 8	yellow	1



LUMINO EASY MAGNET LIGHT



TECHNICAL DATA

- Continuous light and flashing light function at the touch of a button
- Rechargeable via micro USB
- High-quality high-gloss material, yellow with 4 red LEDs
- The luminous band closes easily with the magnetic clasp
- LED light shines for up to 10 hours (after charging)
- Suitable for rainy weather thanks to fully welded-in, waterproof exterior
- Visibility of 150 metres at night and 100 metres during the day
- Tested according to European standard EN 13356:2001

Ref. No.	EAN 4003318	Colour	Size	Box Qty
Lumino Easy Magnet Light yellow	69960 3	yellow		1

LUMINO INDICATOR LIGHT



TECHNICAL DATA

- Continuous and flashing light function at the touch of a button
- Incl. replaceable battery CR2032
- High-quality high-gloss material, yellow with 4 red, powerful LEDs
- With practical Velcro fastener for attaching to various objects
- Light lasts up to 100 hours
- Suitable for rainy weather thanks to fully welded-in, waterproof exterior

Ref. No.	EAN 4003318	Colour	Size	Box Qty
Lumino Indicator Light yellow	69958 0	yellow		1

LUMINO ACTIVE BAR



TECHNICAL DATA

- Continuous and flashing light function at the touch of a button
- Incl. replaceable battery CR2032
- Light lasts up to 100 hours
- Suitable for rainy weather thanks to fully welded-in, waterproof exterior
- Tested according to European standard EN 13356:2001
- Visibility of 150 metres at night and 100 metres during the day

Ref. No.	EAN 4003318	Colour	Box Qty
Lumino Active Bar yellow/black	69957 3	yellow/black	1

RAIN CAP



TECHNICAL DATA

- Elastic band for individual adjustment of the cap to the helmet size

VARIANTES



yellow

black

Ref. No.	EAN 4003318	Colour	Size	Box Qty
Raincap	52151 5	yellow	universal	1
Raincap	52154 6	black	universal	1

SUCCESSFUL SHOP DESIGN

How you design your shop is a significant part of your economic success from a psychological perspective. We help you in the process of making your showroom a customer-friendly area. By doing so, you do not only ensure successful sales today, but also in the future. Because your customers will always come back.

1. STAND OUT

Make your business stand out from the crowd and ensure that your customers feel comfortable in your shop with a warm atmosphere.

2. QUALITY WINS

Many years of experience, carefully thought out development processes and high-quality materials are significant for the products themselves as well as for the presentation aids. ABUS has the complete package.

3. BE REMEMBERED

Create experiences, that go beyond the simple provision and sale of goods. Touch, try out - go on a discovery tour. This is your advantage especially compared to online businesses.



WE SUPPORT YOU IN SELLING OUR PRODUCTS

Your needs are very important to us. We support you in the process of creating experiences and transforming the purchase into an event, which you like to think back to - and that you want to repeat.

MODULAR CONSTRUCTION:

Our new system is designed in such a way that it can be assembled in a modular way from various elements. You can influence the design.

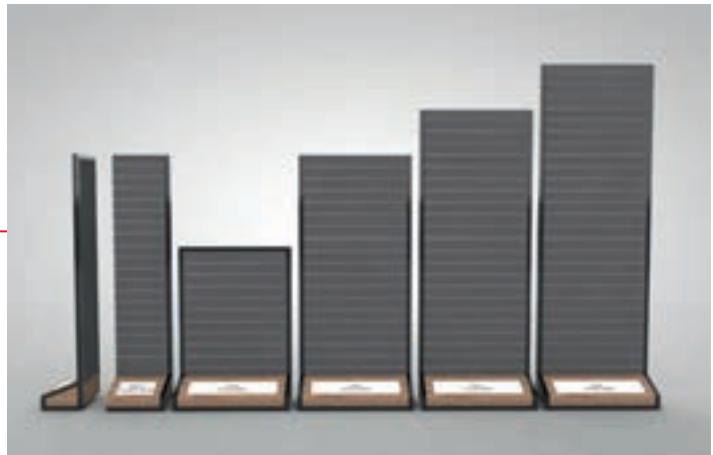

NUMEROUS ADD-ONS:

Attract attention, help to categorize and inform - combine the tools just the way you need them.

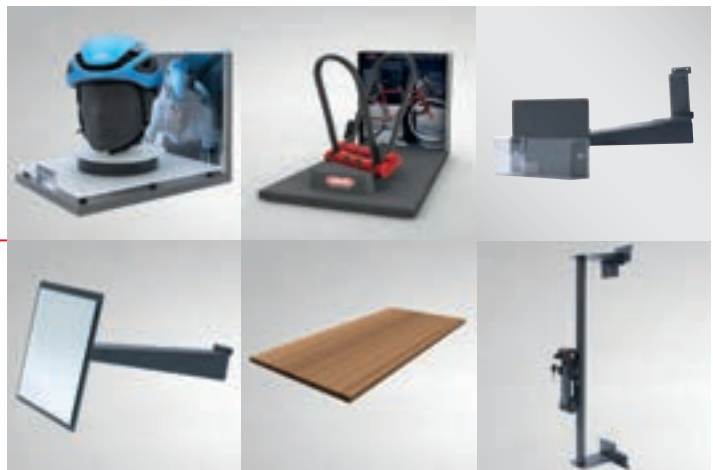

MODERN DESIGN:

Metal and wood elements combined in an understated „handmade“ look - won't disrupt the existing design of your shop.

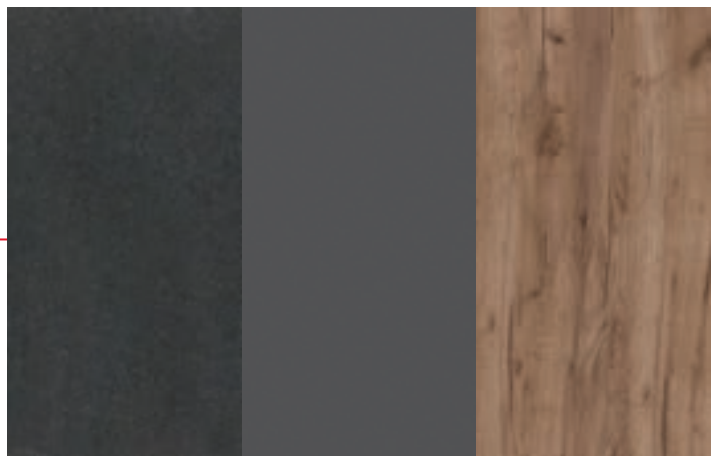

Powder coating
DB703 micro-
structure

Graphite Grey
Kronospan Decor
0162

Tobacco Craft Oak
Kronospan Decor
K004

PUT TOGETHER YOUR PERSONAL ABUS SALES AREA NOW!

WALL DISPLAY

Make full use of height and width of your walls to draw attention to the products. The combination of a solid base and stable back/rear wall ensures a secure stand.



WALL DISPLAY DIMENSIONS:

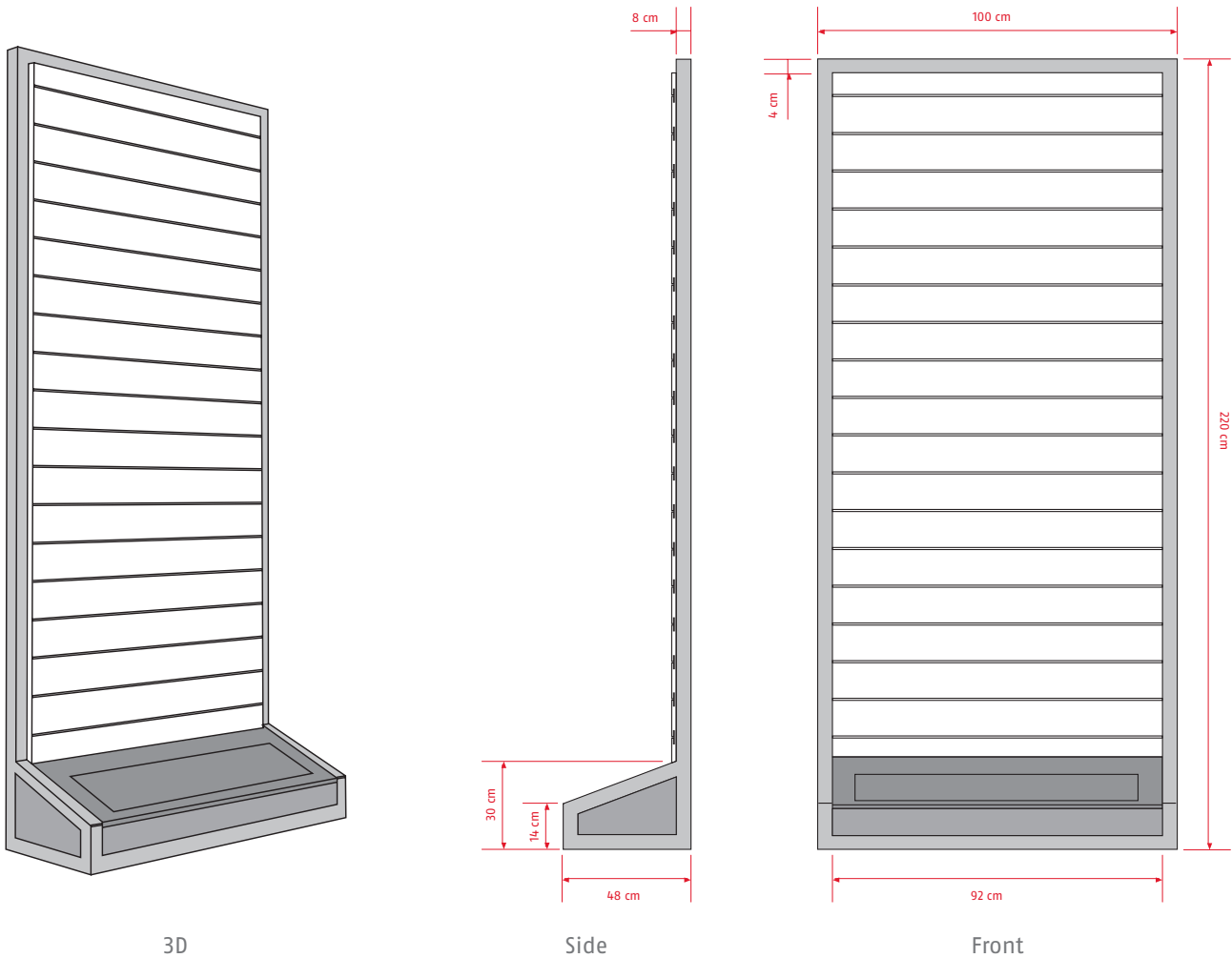

FEATURES WALL DISPLAY:

Available in 100 cm or 50 cm width, depth 35 cm

Height: 140-260 cm (variable in 40-cm-steps thanks to additional spacers)

Slatwall with option for power supply for lighting etc.



Base in wood look with interchangeable inlays

Optional with removable lid (usable as storage space)

Choose from our range of full-surface, illuminated picture elements

FREESTANDING/DETACHED DISPLAY

Expand and structure product categories with freestanding displays - for example for new and promotional products. Thank to optional castors, the freestanding displays can be moved to a new position at any time



MEASUREMENTS FREE STANDING DISPLAY:

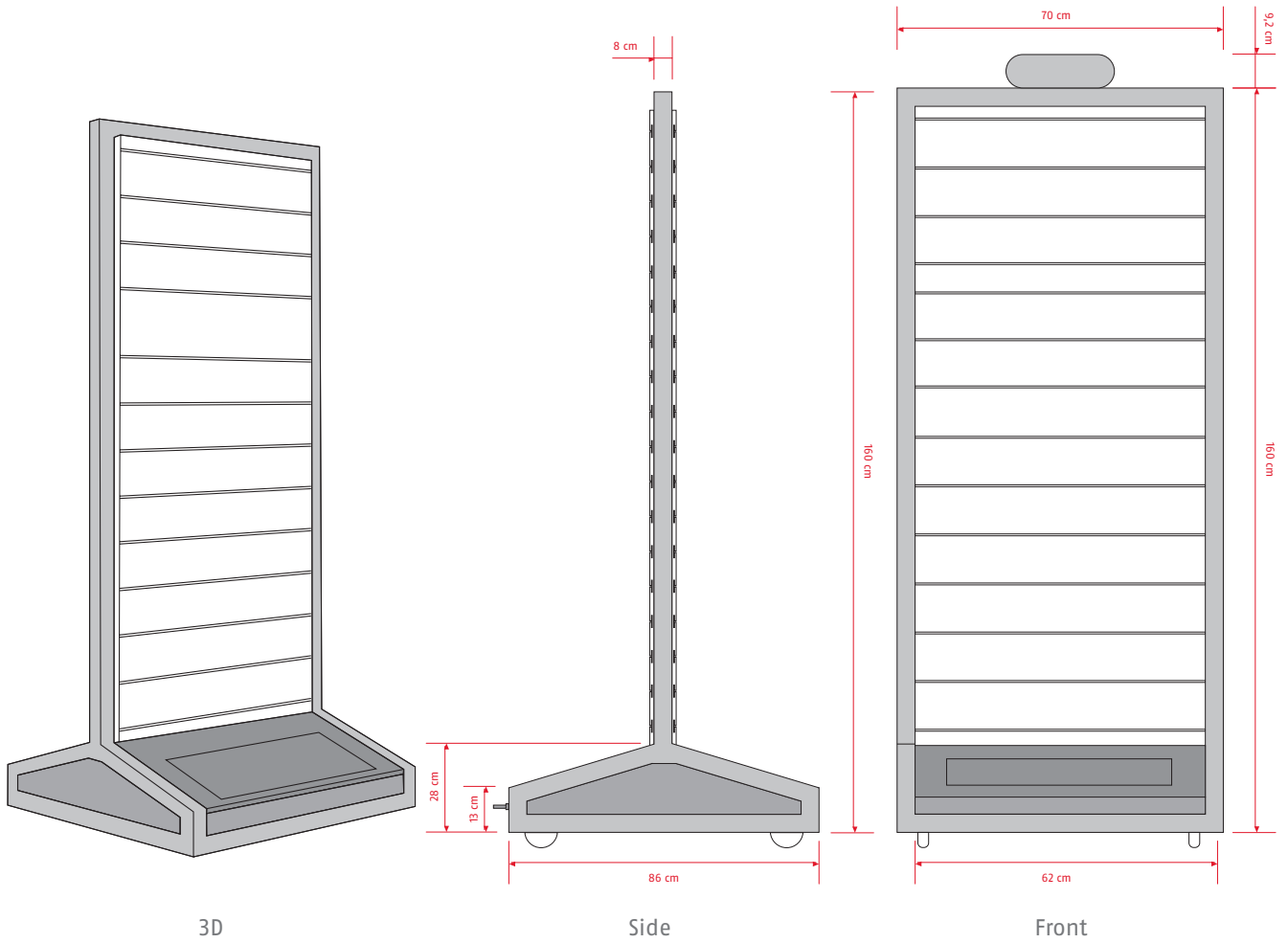

FEATURES FREE STANDING DISPLAY:

Base in wood look with interchangeable inlays

Optional with removable lid (usable as storage space)

Castors for easy re-positioning (optionally available)



BE INSPIRED

Our new product presentation system offers a wide range of possible combinations. You can choose and equip your displays to match your product range and your premises.



FUNCTIONALITY AND EMOTIONALITY IN HARMONY

Combined correctly, the individual elements offer many advantages.



Very good balance of merchandising density and matching picture elements

Easy/simple orientation via category signs

Large selection of illuminated picture elements for the tension frames



Inserts with product information as a decision-making aid

Order and clarity thanks to storage space in the base

INDEX

Ref. No.	Page	Ref. No.	Page	Ref. No.	Page
Locks		Locks		Brackets and Bags	
64TI	125	GRANIT™ WBA 75	111	Bag ST 5850/5650/4960	141
70 & 70IB	126	IVEN Chain 8210	50	BASICO ST 5200	146
145	124	IVEN Steel-0-Flex™ 8200	68	Bracket EaZy KF™	133
147TSA	127	IVERA Cable 7220	84	Bracket Fidlock FL	142
402	25	IVERA Chain 7210	51	Bracket Fidlock TexFL	142
440 Alarm	23	IVERA Chain 7210 Color	51	Bracket GH 50	134
1200 Web	61	IVERA Steel-0-Flex™ 7200	69	Bracket IVERA RBU	139
1500 Web	61	IVY Chain 9210	47	Bracket KF	144
1850	117	IvyTex Adapter Chain	101	Bracket Quick Store QST	140
3406C	89	KeyGarage™ 767	123	Bracket QuickSnap	143
3406K	89	KeyGarage™ 787	121	Bracket QuickSnap RBU	143
3506C	83	KeyGarage™ 787 BIG	120	Bracket Saddlefix QST	140
3506K	83	KeyGarage™ 787 BIG LED	120	Bracket Saddlefix SH SF	135
4408C	88	KeyGarage™ 787 LED	121	Bracket SCLL	141
4408K	88	KeyGarage™ 797	122	Bracket Selle Royale (5C,5K,6C,6K)	142
4650S / SL	98	KeyGarage™ 797 LED	122	Bracket SH 5700 BORDO™	137
4650X / XL	98	KeyGarage™ Smart 787	119	Bracket SH 5700 uGrip BORDO™ BIG	137
6206K Goose Lock	65	KeyGarage™ Smart 797	119	Bracket SH 6000 BORDO™	136
8808C	49	Microflex 6615K	73	Bracket SH 6000 BORDO™ BIG	137
ACH 2.0 Adaptor Chain	100	Numerino 5410C	87	Bracket SH 6055 BORDO™ Lite	138
ADAPTOR CABLE	100	Numero 5510C	81	Bracket SH 6055 Selle Royal	138
AFS625	118	PHANTOM™ 8950	78	Bracket SH 6500 BORDO XPlus™	136
Alarmbox 2.0	109	PHANTOM™ 8960	70	Bracket SH 6500K BORDO™	135
Alarmbox RC	109	Primo 5410K	87	Bracket SH B	132
Booster 6512K	80	Primo 5510K	81	Bracket SH FL	136
BORDO GRANIT™ 6500K	32	PRO AMPARO 4750 S / SL	97	Bracket SH6500A SmartX™	135
BORDO GRANIT™ 6500KA	31	PRO AMPARO 4750 X / XL	96	Bracket Snap Cage	141
BORDO™ 6000C	36	PRO TECTIC™ 4960	99	Bracket ST 5700 uGrip BORDO™	139
BORDO™ 6000C LED	37	PS88	118	Bracket ST 6000 BORDO™	138
BORDO™ 6000K	35	Racer 6412K	86	Bracket ST 6000 BORDO™ BIG	139
BORDO™ 6000KA	34	Raydo Pro 1450	79	Bracket TexKF Mini	143
BORDO™ 6500A SmartX	30	Sportflex 2504	114	Bracket UGH 02	134
BORDO™ Lite 6055C	41	Star 4508C	82	Bracket URB	144
BORDO™ Lite 6055K	40	Star 4508K	82	Bracket USH 540 / 470 / 460 / 440A TEX	133
BORDO™ One 6000A	33	Steel-0-Chain™ 4804C	60	Bracket USKF	133
Catena 6806K	56	Steel-0-Chain™ 4804C SYMBOLS	60	Chain Bag ST 2012	140
Catena 6806 Color	57	Steel-0-Chain™ 4804K	59	Clutching Strap LH adaptor	144
Catena 6806K Neon	56	Steel-0-Chain™ 5805C	58	Oryde ST 2085	145
Catena 6806K Reflective	57	Steel-0-Chain™ 5805K	58	Oryde ST 2100	146
Centuro 860	69	Steel-0-Chain™ 8807K	52	Oryde ST 2200	145
Chain 6KS Loop	116	Steel-0-Chain™ 9808K	48	Oryde ST 2250	145
Chain Claw 10	108	Steel-0-Chain™ 9809K	48	Shackle Clamp	134
CityChain™ 1010	47	Steel-0-Flex™ 950	68	ST 5950 2.0	146
Cobra™	117	Steel-0-Flex™ Raydo Pro 1460	71		
Combiflex™	114	Steel-0-Flex™ Tresor 1360	72		
Combiflex™ Adventure	115	TECTIC™ 496	99		
Combiflex™ Travelguard	115	Tresor 1385	53		
CombiLoop 205	116	Tresor 1385 Color	54		
Diskus® 20	127	Tresor 1385 Neon	55		
Diskus® 24IB	126	Tresor 6412C	86		
Facilo 32	25	Tresor 6512C	80		
GRANIT CityChain XPlus™ 1060	46	Tresorflex 6615C	73		
GRANIT XPlus™ 540	18	uGrip BORDO™ 5700 Combo	39		
GRANIT XPlus™ 6950	94	uGrip BORDO™ 5700K	38		
GRANIT™ 460	22	Ultimate 420	21		
GRANIT™ Power 58	16	Ultra 410	24		
GRANIT™ Plus 470	20	WA 50	113		
GRANIT™ Plus 640	19	WBA 60	113		
GRANIT™ Super Extreme 2500	17	WBA 65	112		
GRANIT™ WBA 100	111	WCH90	110		

INDEX

Ref. No.	Page	Ref. No.	Page
Helmets		Lumino	
ABUS Bag	267	Active Bar	277
Aduro 3.0	236 - 237	Easy Magnet Light	276
AirBreaker	160 - 161	Indicator Light	276
AirDrop	182 - 183	Lumino Day Vest	270
Buteo	194 - 195	Lumino Night Vest	270
CliffHanger	186 - 187	Night Cover	274
GameChanger 2.0	166 - 167	Raincap	277
GameChanger TRI	164 - 165	Reflex Vest	271
GameChanger TT	162 - 163	Reflex Vest Kids	272
Helmet bag sportiv	267	Reflex Wrap	275
HiDrop	184 - 185	Urban Vest	271
HUD-Y	212 - 213	Urban Vest Kids	272
HUD-Y ACE	210 - 211	X-Urban Cover	274
Hyban 2.0	226 - 227		
Hyban 2.0 ACE	224 - 225		
Hyban 2.0 LED	222 - 223		
Light accessories	266		
Light accessories	265		
Light accessories	265		
Macator	176 - 177		
MoDrop	190 - 191		
MoTrip	192 - 193		
Moventor 2.0	188 - 189		
Pad Fresh MS Cleaning spray	266		
Pedelec 1.1	208 - 209		
Pedelec 2.0	206 - 207		
Pedelec 2.0 ACE	204 - 205		
Pedelec 2.0 Earpads	262		
Pedelec 2.0/Hyban 2.0/HUD-Y ACE	264		
Spare shield			
PowerDome	172 - 173		
PowerDome ACE	170 - 171		
PURL-Y	220 - 221		
PURL-Y ACE	218 - 219		
QUIN sensor	267		
Race Cap	263		
Rain Cap	263		
Rain Cap Toplight	263		
Reflector Stickerset	267		
Replacement Hyban+ visor	264		
Scraper 3.0	234 - 235		
Scraper 3.0 ACE	232 - 233		
Scraper 3.0 Winter Kit	262		
Skurb	230 - 231		
Skurb ACE	228 - 229		
Skurb Kid	250 - 251		
Smiley 3.0	256 - 257		
Smiley 3.0 ACE LED	252 - 253		
Smiley 3.0 LED	254 - 255		
Smooty 2.0	258 - 259		
StormChaser ACE	168 - 169		
Urban-I 3.0	216 - 217		
Urban-I 3.0 ACE	214 - 215		
USB light Aduro 3.0	266		
Verres pour masque BUTEO	265		
Visor GameChanger TT/Tri	264		
WingBack	174 - 175		
Winter Kit	262		
YouDrop	244 - 245		
YouDrop FF	242 - 243		
Youn-I 2.0	246 - 247		
Youn-I MIPS	248 - 249		

We do not undertake any liability for modifications in technology, changes in colour and errors. ABUS 07/2023
VAT ID: DE 126881051
RRP (Status 07/2022)

*RRP= recommended retail price incl. the current valid sales tax



Security Tech Germany

© ABUS | August Bremicker Söhne KG
abus.com

Altenhofer Weg 25
58300 Wetter | Germany
mobilesecurity@abus.de
+49 2335 - 634 0

