

## HDCC35500



- Ⓛ **Bedienungsanleitung**
- Ⓜ **User manual**
- Ⓝ **Manuel utilisateur**
- Ⓞ **Gebruikershandleiding**
- Ⓟ **Brugerhåndbog**
- Ⓠ **Struzioni per l'uso**

<p>Ⓛ</p>	<p><b>Diese Bedienungsanleitung enthält wichtige Hinweise zur Inbetriebnahme und Handhabung. Achten Sie hierauf, auch wenn Sie dieses Produkt an Dritte weitergeben. Heben Sie deshalb diese Bedienungsanleitung zum Nachlesen auf!</b></p> <p>Eine Auflistung der Inhalte finden Sie im Inhaltsverzeichnis mit Angabe der entsprechenden Seitenzahlen auf <b>Seite 7</b>.</p>	<p>Ⓛ</p>	<p><b>Denne manual hører sammen med dette produkt. Den indeholder vigtig information som skal bruges under opsætning og efterfølgende ved service. Dette skal huskes også når produkter gives videre til anden part. Læs derfor denne manual grundigt igennem også for fremtiden.</b></p> <p>Indholdet kan ses med sideanvisninger kan findes i indekset på <b>side 59</b>.</p>
<p>Ⓛ</p>	<p><b>This user manual contains important information for installation and operation. This should be also noted when this product is passed on to a third party. Therefore look after these operating instructions for future reference!</b></p> <p>A list of contents with the corresponding page number can be found in the index on <b>page 20</b>.</p>	<p>Ⓛ</p>	<p><b>Le presenti istruzioni per l'uso contengono informazioni importanti sulla messa in funzione e sull'utilizzo dell'impianto. Vanno osservate anche in caso di cessione del prodotto a terzi. Conservare pertanto le presenti istruzioni per l'uso in vista di una consultazione futura.</b></p> <p>Un elenco dei contenuti con l'indicazione delle pagine corrispondenti è riportato nell'indice a <b>pagina 72</b>.</p>
<p>Ⓛ</p>	<p><b>Ce mode d'emploi appartient à de produit. Il contient des recommandations en ce qui concerne sa mise en service et sa manutention. Veuillez en tenir compte et ceci également lorsque vous remettez le produit à des tiers. Conservez ce mode d'emploi afin de pouvoir vous documenter en temps utile!</b></p> <p>Vous trouverez le récapitulatif des indications du contenu à la table des matières avec mention de la page correspondante à la <b>page 33</b>.</p>		
<p>Ⓛ</p>	<p><b>Deze gebruiksaanwijzing hoort bij dit product. Er staan belangrijke aanwijzingen in betreffende de ingebruikname en gebruik, ook als u dit product doorgeeft aan derden. Bewaar deze handleiding zorgvuldig, zodat u deze later nog eens kunt nalezen!</b></p> <p>U vindt een opsomming van de inhoud in de inhoudsopgave met aanduiding van de paginanummers op <b>pagina 46</b>.</p>		

## HDCC35500



## Bedienungsanleitung

Version 02/2019



*Originalbedienungsanleitung in deutscher Sprache. Für künftige Verwendung aufbewahren!*

## Einführung

Sehr geehrte Kundin, sehr geehrter Kunde,  
wir bedanken uns für den Kauf dieses Produkts.

Das Gerät erfüllt die Anforderungen der folgenden EU-Richtlinien: EMV Richtlinie 2014/30/EU sowie RoHS Richtlinie 2011/65/EU.

Um diesen Zustand zu erhalten und einen gefahrenlosen Betrieb sicherzustellen, müssen Sie als Anwender diese Bedienungsanleitung beachten!

Lesen Sie sich vor Inbetriebnahme des Produkts die komplette Bedienungsanleitung durch, beachten Sie alle Bedienungs- und Sicherheitshinweise!

**Alle enthaltenen Firmennamen und Produktbezeichnungen sind Warenzeichen der jeweiligen Inhaber. Alle Rechte vorbehalten.**

**Bei Fragen wenden Sie sich an ihren Facherrichter oder Fachhandelspartner!**



### Haftungsausschluss



Diese Bedienungsanleitung wurde mit größter Sorgfalt erstellt. Sollten Ihnen dennoch Auslassungen oder Ungenauigkeiten auffallen, so teilen Sie uns diese bitte schriftlich unter der auf der Rückseite des Handbuchs angegebenen Adresse mit.

Die ABUS Security-Center GmbH & Co. KG übernimmt keinerlei Haftung für technische und typographische Fehler und behält sich das Recht vor, jederzeit ohne vorherige Ankündigung Änderungen am Produkt und an den Bedienungsanleitungen vorzunehmen.



ABUS Security-Center ist nicht für direkte und indirekte Folgeschäden haftbar oder verantwortlich, die in Verbindung mit der Ausstattung, der Leistung und dem Einsatz dieses Produkts entstehen.

Es wird keinerlei Garantie für den Inhalt dieses Dokuments übernommen.

## Symbolerklärung

	<b>Das Symbol mit dem Blitz im Dreieck wird verwendet, wenn Gefahr für die Gesundheit besteht, z.B. durch elektrischen Schlag.</b>
	<b>Ein im Dreieck befindliches Ausrufezeichen weist auf wichtige Hinweise in dieser Bedienungsanleitung hin, die unbedingt zu beachten sind.</b>
	<b>Dieses Symbol ist zu finden, wenn Ihnen besondere Tipps und Hinweise zur Bedienung gegeben werden sollen.</b>

## Wichtige Sicherheitshinweise

	<b>Bei Schäden die durch Nichtbeachten dieser Bedienungsanleitung verursacht werden, erlischt der Garantieanspruch. Für Folgeschäden übernehmen wir keine Haftung!</b>
	<b>Bei Sach- oder Personenschäden, die durch unsachgemäße Handhabung oder Nichtbeachten der Sicherheitshinweise verursacht werden, übernehmen wir keine Haftung. In solchen Fällen erlischt jeder Garantieanspruch!</b>

**Sehr geehrte Kundin, sehr geehrter Kunde, die folgenden Sicherheits- und Gefahrenhinweise dienen nicht nur zum Schutz Ihrer Gesundheit, sondern auch zum Schutz des Geräts. Lesen Sie sich bitte die folgenden Punkte aufmerksam durch:**

- Es sind keine zu wartenden Teile im Inneren des Produktes. Außerdem erlischt durch das Zerlegen die Zulassung (CE) und die Garantie/Gewährleistung.
- Durch den Fall aus bereits geringer Höhe kann das Produkt beschädigt werden.
- Montieren Sie das Produkt so, dass direkte Sonneneinstrahlung nicht auf den Bildaufnehmer des Gerätes fallen kann. Beachten Sie die Montagehinweise in dem entsprechenden Kapitel dieser Bedienungsanleitung.
- Das Gerät ist für den Einsatz im Innen- und Außenbereich (IP67) konzipiert.

Vermeiden Sie folgende widrige Umgebungsbedingungen bei Betrieb:

- Nässe oder zu hohe Luftfeuchtigkeit
- Extreme Kälte oder Hitze
- Direkte Sonneneinstrahlung
- Staub oder brennbare Gase, Dämpfe oder Lösungsmittel
- starke Vibrationen
- starke Magnetfelder, wie in der Nähe von Maschinen oder Lautsprechern.
- Die Kamera darf nicht auf unbeständigen Flächen installiert werden.

Allgemeine Sicherheitshinweise:

- Lassen Sie das Verpackungsmaterial nicht achtlos liegen! Plastikfolien/-tüten, Styroporsteile usw., könnten für Kinder zu einem gefährlichen Spielzeug werden.
- Die Videoüberwachungskamera darf aufgrund verschluckbarer Kleinteile aus Sicherheitsgründen nicht in Kinderhand gegeben werden.
- Bitte führen Sie keine Gegenstände durch die Öffnungen in das Geräteinnere
- Verwenden Sie nur die vom Hersteller angegebenen Zusatzgeräte/Zubehörteile. Schließen Sie keine nicht kompatiblen Produkte an.
- Bitte Sicherheitshinweise und Bedienungsanleitungen der übrigen angeschlossenen Geräte beachten.
- Überprüfen Sie vor Inbetriebnahme das Gerät auf Beschädigungen, sollte dies der Fall sein, bitte das Gerät nicht in Betrieb nehmen!
- Halten Sie die Grenzen der in den technischen Daten angegebenen Betriebsspannung ein. Höhere Spannungen können das Gerät zerstören und ihre Sicherheit gefährden (elektrischer Schlag).



**Sicherheitshinweise**

1. Stromversorgung: Achten Sie auf die auf dem Typenschild angegebenen Angaben für die Versorgungsspannung und den Stromverbrauch.
2. Überlastung  
Vermeiden Sie die Überlastung von Netzsteckdosen, Verlängerungskabeln und Adaptern, da dies zu einem Brand oder einem Stromschlag führen kann.
3. Reinigung  
Reinigen Sie das Gerät nur mit einem feuchten Tuch ohne scharfe Reinigungsmittel.  
Das Gerät ist dabei vom Netz zu trennen.

**Warnungen**

Vor der ersten Inbetriebnahme sind alle Sicherheits- und Bedienhinweise zu beachten!

1. Beachten Sie die folgenden Hinweise, um Schäden an Netzkabel und Netzstecker zu vermeiden:
  - Wenn Sie das Gerät vom Netz trennen, ziehen Sie nicht am Netzkabel, sondern fassen Sie den Stecker an.
  - Achten Sie darauf, dass das Netzkabel so weit wie möglich von Heizgeräten entfernt ist, um zu verhindern, dass die Kunststoffummantelung schmilzt.
2. Befolgen Sie diese Anweisungen. Bei Nichtbeachtung kann es zu einem elektrischen Schlag kommen:
  - Öffnen Sie niemals das Gehäuse oder das Netzteil.
  - Stecken Sie keine metallenen oder feuergefährlichen Gegenstände in das Geräteinnere.
  - Um Beschädigungen durch Überspannungen (Beispiel Gewitter) zu vermeiden, verwenden Sie bitte einen Überspannungsschutz.
3. Bitte trennen Sie defekte Geräte sofort vom Stromnetz und informieren Ihren Fachhändler.

	Vergewissern Sie sich bei Installation in einer vorhandenen Videoüberwachungsanlage, dass alle Geräte von Netz- und Niederspannungsstromkreis getrennt sind.
	Nehmen Sie im Zweifelsfall die Montage, Installation und Verkabelung nicht selbst vor, sondern überlassen Sie dies einem Fachmann. Unsachgemäße und laienhafte Arbeiten am Stromnetz oder an den Hausinstallationen stellen nicht nur Gefahr für Sie selbst dar, sondern auch für andere Personen. Verkabeln Sie die Installationen so, dass Netz- und Niederspannungskreise stets getrennt verlaufen und an keiner Stelle miteinander verbunden sind oder durch einen Defekt verbunden werden können.

**Auspacken**

Während Sie das Gerät auspacken, handhaben sie dieses mit äußerster Sorgfalt.

	Bei einer eventuellen Beschädigung der Originalverpackung, prüfen Sie zunächst das Gerät. Falls das Gerät Beschädigungen aufweist, senden Sie dieses mit Verpackung zurück und informieren Sie den Lieferdienst.
---	--





**Inhaltsverzeichnis**

- 1. Bestimmungsgemäße Verwendung ..... 8**
- 2. Lieferumfang ..... 8**
- 3. Merkmale und Funktionen ..... 8**
- 4. Beschreibung der Kamera ..... 9**
- 5. Montage / Installation ..... 9**
  - 5.1. Montage der Kamera ..... 9
  - 5.2. Ausrichtung der Kamera ..... 10
  - 5.3. Stromversorgung..... 10
  - 5.4. Anbringung des Video-Kabels..... 11
- 6. Bildschirmmenü..... 11**
  - 6.1. Öffnen des Bildschirmmenüs (OSD) ..... 11
  - 6.2. Beschreibung des Bildschirmmenüs (OSD)..... 11
- 7. Wartung und Reinigung ..... 15**
  - 7.1. Wartung..... 15
  - 7.2. Reinigung..... 15
- 8. Entsorgung..... 15**

**1. Bestimmungsgemäße Verwendung**

Diese Kamera ist sowohl für den Tag- als auch Nachtbetrieb geeignet. Sie liefert Videobilder in Full-HD Auflösung und das Ausgangssignal steht im HD-TVI Format zur Verfügung. Dies ermöglicht die Verwendung von herkömmlichem Koaxialkabel für die Signalübertragung. Sie dient zur Videoüberwachung in Verbindung mit einem Aufzeichnungsgerät. Das Gerät ist für den Einsatz im Innen- und Außenbereich konzipiert.

**2. Lieferumfang**

	
<p>Außen HD-TVI Mini Dome IR</p>	<p>Sicherheitshinweise</p>
	
<p>Installationswerkzeug</p>	<p>Bohrschablone</p>

**3. Merkmale und Funktionen**

- Bis zu 5 Megapixel Auflösung: 2560 x 1944 @ 20 Bilder/Sek.
- Übertragung über herkömmliche CCTV Infrastruktur (Bis zu 500 Meter über ein RG59 Kabel)
- 2,8 mm Fixobjektiv
- 4-in-1-Videoausgang (umschaltbar TVI / AHD / CVI / CVBS)
- IR LEDs für Nachtsicht
- 3D DNR für rauschfreie Bilder
- True WDR Funktion zum Ausgleich von Bildkontrasten (120 dB)
- Wettergeschütztes Kameragehäuse (IP67)
- On-Screen-Menü zur Kamerakonfiguration (Steuerung über DVR über Koaxkabel)



#### 4. Beschreibung der Kamera

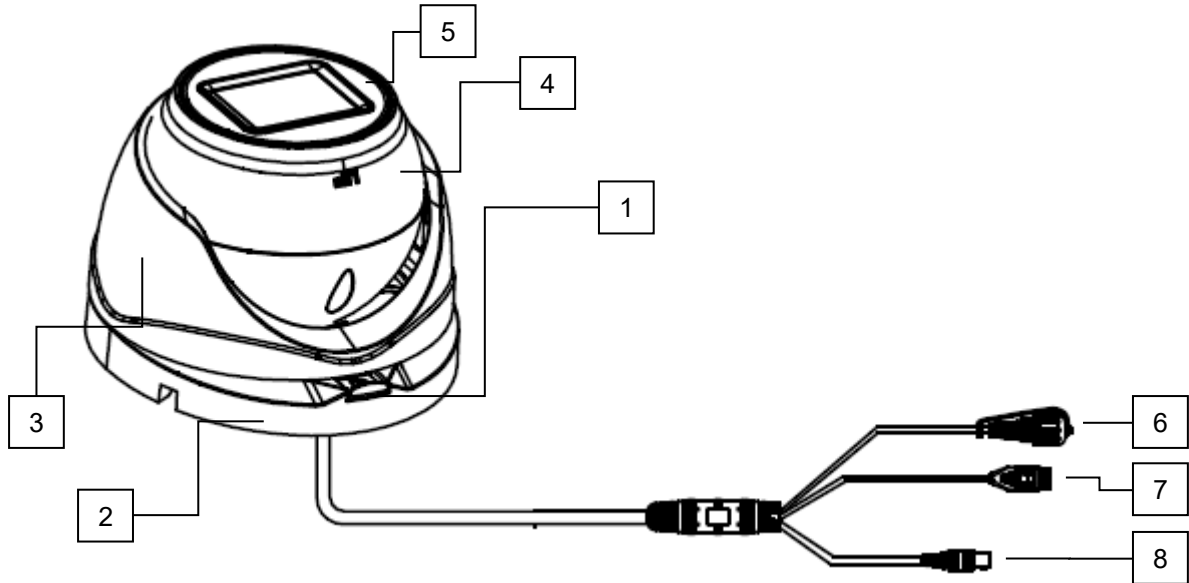

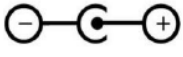
1	Fixierelement mit Fixierschraube
2	Kamerabodenplatte
3	Kamerakappe
4	Kamerakopf
5	IR LEDs
6	Taster zum Umschalten zwischen verschiedenen Videoformaten: TVI / AHD / CVI / FBAS Diese Funktion steht nur in den Auflösungen 4M@25fps und 4M30fps zur Verfügung (Taster jeweils länger als 3 Sekunden gedrückt halten)
7	Spannungsanschluss (5,5x2,1mm, Hohlstecker) 
8	Videoausgang (BNC, Aufdruck „TVI“)

#### 5. Montage / Installation

##### 5.1. Montage der Kamera

	<b>ACHTUNG!</b> Während der Montage muss die Kamera von der Netzspannung getrennt sein.
---	--

Lösen Sie die Fixierschraube an der Kamerabodenplatte und entfernen Sie diese. Benutzen Sie die beigelegte Bohrschablone für die Bohrung der Befestigungslöcher.

Falls die Kabelverlegung seitlich erfolgen soll, so führen Sie zuerst das Anschlusskabel durch die Bodenplatte und die seitliche Öffnung an der Bodenplatte.

Fixieren Sie nun die Bodenplatte.

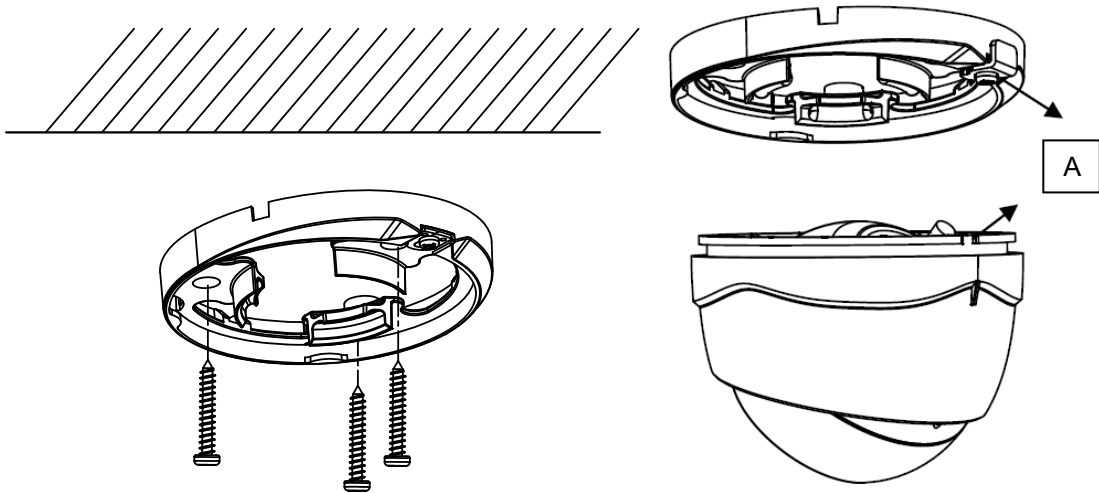

Fixieren Sie dannach den Kamerakopf durch Aufsetzen der Kamerakappe. Der Justiering hat dabei an einer Stelle eine Aussparung (A), an welcher das Fixierelement in den Justiering eingeführt werden kann. Ziehen Sie die Fixierschraube für die Kamerakappe nur leicht an, um die anschließende Kameraausrichtung vorzunehmen.

### 5.2. Ausrichtung der Kamera



Lockern Sie falls nötig die Fixierschraube an der Kamerabodenplatte. Die Ausrichtung des Kameramittelteils kann nun in 3 Achsen vorgenommen werden. Ziehen Sie die Fixierschraube im Anschluss wieder fest.

	(A) Neigen	75°
	(B) Schwenken	360°
	(C) Rotation	360°

Die effektive IR Reichweite ist abhängig vom Einsatzort. Licht absorbierende Oberflächen oder keine IR Licht reflektierende Objekte im Blickfeld reduzieren die IR Reichweite bzw. bedingen ein zu dunkles Videobild. Ferner können reflektierende Objekte in direkter Kameranähe (Dachrinne, Wand) störende Reflektionen des IR Lichtes im Bild zur Folge haben.

**Bitte achten Sie darauf, dass bei den Modellen HDCC35500 die IR LEDs nicht von der Kamerakappe verdeckt werden, da es hier sonst zu Reflektionen kommen kann.**

### 5.3. Stromversorgung

	<b>ACHTUNG!</b> Bevor Sie mit der Installation beginnen, stellen Sie sicher, dass die Versorgungsspannung und die Nennspannung der Kamera übereinstimmen.
	12 VDC, Hohlstecker, 5.5x2.1mm 

Die Kameras erfordern eine 12 VDC Spannungsversorgung. Die Polarität der Gleichspannungsversorgung ist zu beachten!

**5.4. Anbringung des Video-Kabels**

Um das HD-TVI Videosignal der Kamera an einen Rekorder zu übertragen, muss ein Koaxialkabel vom Typ RG59 mit BNC-Stecker (male, männlich) an den Anschluss mit dem Aufdruck „TVI“ angeschlossen werden. Die Kabellänge bis zum nächsten Gerät darf 500 Meter nicht übersteigen.

	Um eine optimale Qualität der Übertragung des HD-TVI Signals zu gewährleisten ist es nötig, dass das Kabel an keiner Stelle geknickt, gequetscht oder in einem zu geringen Radius verlegt wird (min. Biegeradius 6 cm). Falls das Kabel beschädigt oder durch den Alterungsprozess porös geworden ist, dann kann sich das ebenfalls auf die Signal- bzw. Bildqualität auswirken (z.B. Schattenbildung um Kanten).
---	--

**6. Bildschirmenü**

**6.1. Öffnen des Bildschirmenüs (OSD)**

Das Bildschirmenü (OSD, On-Screen-Display) dieser Kamera kann ausschließlich über den ABUS HD-TVI DVR geöffnet werden (inkl. ZOOM/FOKUS). Ziehen Sie dazu die Bedienungsanleitung des ABUS HD-TVI DVR heran.

**6.2. Beschreibung des Bildschirmenüs (OSD)**

Durch Drücken auf die Taste für die OSD-Menü Steuerung öffnen Sie das OSD Bildschirmenü. Über dieses Bildschirmenü können detailliert Einstellungen vorgenommen werden.

**HAUPTMENÜ**

MAIN MENU	
VIDEO FORMAT	<4M25>
EXPOSURE	↓
DAY/NIGHT	↓
VIDEO SETTINGS	↓
FUNCTIONS	↓
FACTORY DEFAULT	↓
EXIT	↓
SAVE&EXIT	↓



**Video Format**

<b>Funktion</b>	<b>Beschreibung</b>
Video Format	<p>Einstellung für die Videoauflösung</p> <p>Optionen:                      5M20: 5 Megapixel @ 20 Bilder/s                      4M25: 4 Megapixel @ 25 Bilder/s (Standard)                      4M30: 4 Megapixel @ 30 Bilder/s                      2M25: 2 Megapixel @ 25 Bilder/s                      2M30: 2 Megapixel @ 30 Bilder/s</p>

**Exposure**

In diesem Menüpunkt werden allgemeine Belichtungseinstellungen eingestellt, z.B. ob die Kamera hohe Kontraste verarbeiten soll, oder die Kamera spezielle Einstellungen für die Nachtsicht benötigt.

<b>Funktion</b>	<b>Beschreibung</b>
Exposure Mode	<p>Global: Generelle automatische Belichtungseinstellung ohne WDR-Funktion</p> <p>BLC: Automatische Belichtungseinstellung mit Gegenlichtkompensation (Back Light Compensation). Die BLC Funktion verbessert die Bilddarstellung bei mittleren Bildkontrasten.</p> <p>WDR: Automatische Belichtungseinstellung mit WDR-Funktion (Wide Dynamic Range). Die WDR-Funktion dient zur verbesserten Darstellung von hohen Bildkontrasten. Diese Funktion verfügt zusätzlich über eine 4 stufige Einstellung zur Anpassung an die gegebenen Kontrastverhältnisse.</p>
AGC	<p>Automatische Verstärkungsregelung. Je höher die Einstellung desto heller erscheint das Videobild bei niedrigen Beleuchtungsverhältnissen, doch umso höher ist das Bildrauschen.</p> <p>Low: Niedrig                      Medium: Mittel                      High: Hoch</p>
Back	Zurück zur vorherigen Menüseite
Exit	Verlassen des Menüs
Save&Exit	Speichern und Verlassen des Menüs

**DAY NIGHT**

In diesem Menüpunkt wird der Modus für die Tag-/Nachtumschaltung eingestellt.

<b>Funktion</b>	<b>Beschreibung</b>
Auto	<p>Automatische Aktivierung/Deaktivierung des Tag- oder Nachtmodus. Der integrierte Lichtsensor steuert die Umschaltung je nach Beleuchtungsstärke.</p> <p>IR Light: On: IR LEDs im Nachtmodus aktiv</p>

	<p>Smart IR:                   Off: IR LEDs im Nachtmodus deaktiv  Funktion zur Reduktion von Überstahlung des  IR Lichtes bei nahen Objekten  On: Funktion aktiv  Off: Funktion deaktiv</p> <p>D-&gt;N Threshold (1-9): Umschaltsschwelle von Tag- zu Nachtmodus  N-&gt;D Threshold (1-9): Umschaltsschwelle von Nacht- zu Tagmodus  Back:                       Zurück zur vorherigen Menüseite</p>
Color	Die Kamera bleibt dauerhaft im Farbmodus. Der Infrarot-Schwenkfilter bleibt dauerhaft vor dem Objektiv, und die IR LEDs sind dauerhaft aus.
B&W	<p>Die Kamera bleibt dauerhaft im Schwarz/Weiß-Modus. Der Infrarot-Schwenkfilter ist dauerhaft vom Objektiv entfernt. Die IR LEDs werden automatisch durch den Lichtsensor gesteuert an- oder abgeschaltet.</p> <p>IR Light:                   On: IR LEDs im Nachtmodus aktiv  Off: IR LEDs im Nachtmodus deaktiv</p> <p>Smart IR:                   Funktion zur Reduktion von Überstahlung des  IR Lichtes bei nahen Objekten  On: Funktion aktiv  Off: Funktion deaktiv</p>

**Video Settings**

In diesem Menüpunkt werden allgemeine Bildeinstellungen wie z.B. Kontrast oder Spiegelung des Videobildes vorgenommen.

Funktion	Beschreibung
Image Mode	<p>In diesem Punkt sind 2 verschiedene Grundeinstellungen der Kamera einstellbar.</p> <p>STD:                       Standardeinstellung  HIGH-SAT:               Einstellung für ein farblich intensiveres Bild</p>
White Balance	<p>Auto:                     Automatischer Weißabgleich</p> <p>Manual:                 Manueller Weißabgleich  R Gain: Verstärkungsfaktor für den Rotanteil im Bild  B Gain: Verstärkungsfaktor für den Blauanteil im Bild</p> <p>Back:                    Zurück zur vorherigen Menüseite  Exit:                     Verlassen des Menüs  Save&amp;Exit:             Speichern und Verlassen des Menüs</p>
Brightness	(1~9):                   Einstellung für die Bildhelligkeit
Contrast	(1~9):                   Einstellung für den Bildkontrast
Sharpness	(1~9):                   Mit dieser Funktion kann elektronisch die Wahrnehmung der Bildschärfe verändert werden.
Saturation	(1~9):                   Sättigung des Videobildes
3DNR	(1~9):                   Einstellung für die Rauschunterdrückungsfunktion. Je höher der eingestellte Wert, desto mehr Rauschen wird aus dem Videobild softwaretechnisch entfernt.

Mirror	Spiegelung des Videobildes  Off: Deaktiviert HV: Horizontale und vertikale Bildspiegelung (Standard) V: Vertikale Bildspiegelung H: Horizontale Bildspiegelung
Back	Zurück zur vorherigen Menüseite
Exit	Verlassen des Menüs
Save&Exit	Speichern und Verlassen des Menüs

## 7. Wartung und Reinigung

### 7.1. Wartung

Überprüfen Sie regelmäßig die technische Sicherheit des Produkts, z.B. Beschädigung des Gehäuses.

Wenn anzunehmen ist, dass ein gefahrloser Betrieb nicht mehr möglich ist, so ist das Produkt außer Betrieb zu setzen und gegen unbeabsichtigten Betrieb zu sichern.

Es ist anzunehmen, dass ein gefahrloser Betrieb nicht mehr möglich ist, wenn

- das Gerät sichtbare Beschädigungen aufweist,
- das Gerät nicht mehr funktioniert

	<p><b>Bitte beachten Sie:</b></p> <p>Das Produkt ist für Sie wartungsfrei. Es sind keinerlei für Sie überprüfende oder zu wartende Bestandteile im Inneren des Produkts, öffnen Sie es niemals.</p>
---	---

### 7.2. Reinigung

Reinigen Sie das Produkt mit einem sauberen trockenen Tuch. Bei stärkeren Verschmutzungen kann das Tuch leicht mit lauwarmem Wasser angefeuchtet werden.

	<p>Achten Sie darauf, dass keine Flüssigkeiten in das Gerät gelangen. Verwenden Sie keine chemischen Reiniger, dadurch könnte die Oberfläche des Gehäuses und des Bildschirms angegriffen werden (Verfärbungen).</p>
---	--

## 8. Entsorgung

	<p>Achtung: Die EU-Richtlinie 2002/96/EG regelt die ordnungsgemäße Rücknahme, Behandlung und Verwertung von gebrauchten Elektronikgeräten. Dieses Symbol bedeutet, dass im Interesse des Umweltschutzes das Gerät am Ende seiner Lebensdauer entsprechend den geltenden gesetzlichen Vorschriften und getrennt vom Hausmüll bzw. Gewerbemüll entsorgt werden muss. Die Entsorgung des Altgeräts kann über entsprechende offizielle Rücknahmestellen in Ihrem Land erfolgen. Befolgen Sie die örtlichen Vorschriften bei der Entsorgung der Materialien. Weitere Einzelheiten über die Rücknahme (auch für Nicht-EU Länder) erhalten Sie von Ihrer örtlichen Verwaltung. Durch das separate Sammeln und Recycling werden die natürlichen Ressourcen geschont und es ist sichergestellt, dass beim Recycling des Produkts alle Bestimmungen zum Schutz von Gesundheit und Umwelt beachtet werden.</p>
---	---

## HDCC35500



## User guide

Version 02/2019



*English translation of the original German user manual. Retain for future reference.*



## Introduction

Dear customer,

Thank you for purchasing this product.

The device complies with the requirements of the following EU directives: EMC Directive 2014/30/EU and the RoHS Directive 2011/65/EU.

To ensure this condition is maintained and that safe operation is guaranteed, it is your obligation to observe this user guide.

Please read the entire user guide carefully before putting the product into operation, and pay attention to all operating instructions and safety information.

**All company names and product descriptions are trademarks of the corresponding owner. All rights reserved.**

**In the event of questions, please contact your local maintenance specialist or dealer.**





### Disclaimer

This user guide has been produced with the greatest of care. Should you discover any omissions or inaccuracies however, please inform us in writing at the address provided on the back of the manual. ABUS Security-Center GmbH & Co. KG assumes no liability for technical and typographical errors, and reserves the right to make changes to the product and user manuals at any time and without prior notice.



ABUS Security-Center GmbH is not liable or responsible for direct or indirect damage resulting from the equipment, performance and use of this product.

No guarantee is made for the contents of this document.

## Explanation of symbols

	The triangular high voltage symbol is used to warn of the risk of injury or health hazards (e.g. caused by electric shock).
	The triangular warning symbol indicates important notes in this user guide which must be observed.
	This symbol indicates special tips and notes on the operation of the unit.

## Important safety information

	All guarantee claims are invalid in the event of damage caused by non-compliance with this user guide. We cannot be held liable for resulting damage.
	We cannot be held liable for material or personal damage caused by improper operation or non-compliance with the safety information. All guarantee claims are void in such cases.

The following safety information and hazard notes are not only intended to protect your health, but also to protect the device from damage. Please read the following points carefully:

- There are no components inside the product that require servicing. Dismantling the product invalidates the CE certification and the guarantee/warranty.
- The product may be damaged if it is dropped, even from a low height.
- Install the device so that the image sensor is not subjected to direct sunlight. Pay attention to the installation instructions in the corresponding section of this user manual.
- The device is designed for indoor and outdoor use (IP67).

Avoid the following adverse conditions during operation:

- Moisture or excess humidity
- Extreme heat or cold
- Direct sunlight
- Dust, flammable gases, vapours, or solvents
- Strong vibrations
- Strong magnetic fields (e.g. next to machines or loudspeakers)
- The camera must not be installed on unstable surfaces.

General safety information:

- Do not leave packaging material lying around. Plastic bags, sheeting, polystyrene packaging, etc., can pose a danger to children if played with.
- The video surveillance camera contains small parts which could be swallowed and must be kept out of the reach of children for safety reasons.
- Do not insert any objects into the device through the openings.
- Only use replacement devices and accessories that are approved by the manufacturer. Do not connect any non-compatible products.
- Please pay attention to the safety information and user manuals for the other connected devices.
- Check the device for damage before putting it into operation. Do not put the device into operation if you identify any damage.
- Adhere to the normal voltage limits specified in the technical data. Higher voltages could destroy the device and pose a health risk (electric shock).



**Safety information**

1. Power supply: Note the information provided on the type plate for supply voltage and power consumption.
2. Overloading  
Avoid overloading electrical sockets, extension cables and adapters, as this can result in fires or electric shocks.
3. Cleaning  
Only use a damp cloth to clean the device. Do not use corrosive cleaning materials.  
Disconnect the device from the power supply before cleaning.

**Warnings**

Observe all safety and operating instructions before putting the device into operation for the first time.

1. Observe the following information to avoid damage to the power cable and plug:
  - Do not pull the cable when disconnecting the device from the power – always take hold of the plug.
  - Ensure that the power cable is positioned as far away as possible from any heating equipment, as this could otherwise melt the plastic coating.
2. Follow these instructions. Non-compliance with these instructions could lead to an electric shock.
  - Never open the housing or power supply unit.
  - Do not insert any metallic or flammable objects into the device.
  - Use surge protection to prevent damage caused by overvoltage (e.g. in electrical storms).
3. Disconnect defective devices from the power immediately and contact your specialist dealer.

	When installing the device in an existing video surveillance system, ensure that all devices have been disconnected from the power supply and low-voltage circuit.
	If in doubt, have a specialist technician carry out assembly, installation and connection of the device. Improper or unprofessional work on the mains network or domestic installations puts both you and others at risk. Connect the installations so that the mains power circuit and low-voltage circuit always run separately from each other. They should not be connected at any point or become connected as a result of a malfunction.

**Unpacking the device**

Handle the device with extreme care when unpacking it.

	If the original packaging has been damaged, inspect the device. If the device shows signs of damage, return it in the original packaging and inform the delivery service.
---	---



## Contents

<b>1. Intended use</b> .....	<b>21</b>
<b>2. Scope of delivery</b> .....	<b>21</b>
<b>3. Features and functions</b> .....	<b>21</b>
<b>4. Camera description</b> .....	<b>22</b>
<b>5. Mounting / Installation</b> .....	<b>22</b>
5.1. Mounting the camera .....	22
5.2. Orientation of the camera.....	23
5.3. Power supply.....	24
5.4. Connecting the video cable.....	24
<b>6. On-screen display</b> .....	<b>25</b>
6.1. Opening the on-screen display .....	25
6.2. Description of the on-screen display .....	25
<b>7. Maintenance and cleaning</b> .....	<b>29</b>
7.1. Maintenance.....	29
7.2. Cleaning.....	29
<b>8. Disposal</b> .....	<b>29</b>

### 1. Intended use

This camera is designed for both daytime and night-time use. It provides video images in full HD resolution. The output signal is provided in HD-TVI format. This allows the use of a conventional coaxial cable for signal transmission. It is used for video surveillance in conjunction with a recording device. The device is designed for indoor and outdoor use.

### 2. Scope of delivery

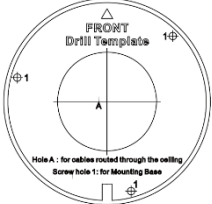
	
<p>Outdoor HD-TVI Mini Dome IR</p>	<p>Safety information</p>
	
<p>Installation tool</p>	<p>Drilling template</p>

### 3. Features and functions

- Up to 5 megapixel resolution: 2560 x 1944 @ 20 fps
- Transmission via conventional CCTV infrastructure (up to 500 m via RG59 cable)
- 2.8 mm fixed lens
- 4 in 1 video output (switchable TVI/AHD/CVI/CVBS)
- IR LEDs for night vision
- 3D DNR function for noise-free images
- True WDR function to compensate for image contrasts (120 dB)
- Weatherproof camera housing (IP67)
- On-screen display for camera configuration (control via DVR via coaxial cable)

4. Camera description

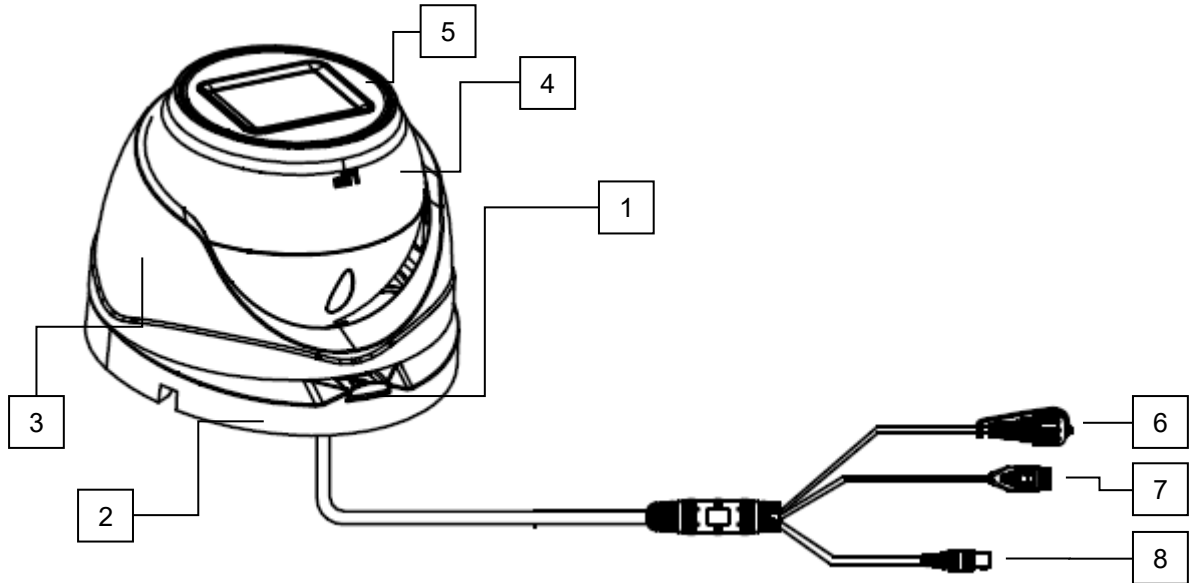

1	Fixing element with fixing screws
2	Camera base plate
3	Camera cap
4	Camera head
5	IR LEDs
6	Button for switching between different video formats: TVI / AHD / CVI / CVBS This function is only available in the 4M @ 25fps and 4M30fps resolutions (keep the button pressed for longer than 3 seconds)
7	Power supply connection (5.5 x 2.1 mm, barrel connector) 
8	Video output (BNC, labelled 'TVI')

5. Mounting / Installation

5.1. Mounting the camera

	<p><b>IMPORTANT!</b> The camera must be disconnected from the power supply during installation.</p>
---	---

Loosen the fixing screws on the camera base plate and remove them. Use the accompanying drilling template for drilling the mounting holes.

If the cable is to be routed through the side, first guide the connecting cable through the base plate and the side opening on the base plate.

Now fix the base plate in place.

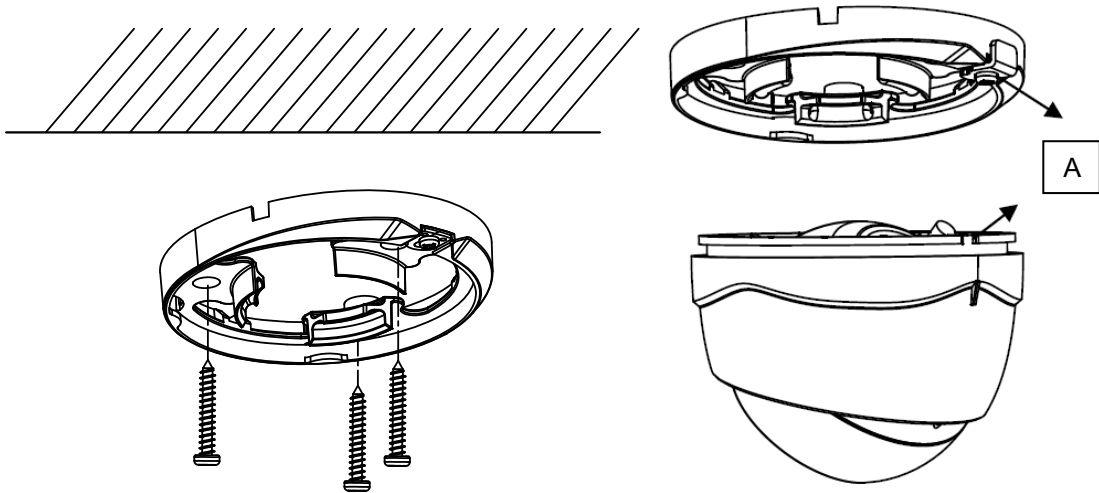

Then fix the camera head in place by attaching the camera cap. The adjustment ring has an opening (A), which the fixing element can be slotted into. Loosely tighten the fixing screw for the camera cap to allow you to perform camera orientation.



**5.2. Orientation of the camera**

Loosen the fixing screw on the camera base plate if necessary. The camera centre section can now be oriented in three axes. Tighten the fixing screw again when finished.

	<table border="0"> <tr> <td>(A) Tilt</td> <td>90°</td> </tr> <tr> <td>(B) Pivot</td> <td>360°</td> </tr> <tr> <td>(C) Rotation</td> <td>360°</td> </tr> </table>	(A) Tilt	90°	(B) Pivot	360°	(C) Rotation	360°
(A) Tilt	90°						
(B) Pivot	360°						
(C) Rotation	360°						

 The effective IR range will depend on the installation location. If there are surfaces that absorb light or no objects that reflect IR light in the field of view, the IR range will be reduced and/or the video image will be too dark. Reflective objects in the immediate vicinity of the camera (e.g. roof gutter or wall) may also result in the reflection of IR light, which can disturb the image.  
With the HDCC35500 model, it is important to ensure that the IR LEDs are not covered by the camera cap, as this could cause reflections.

### 5.3. Power supply

	<b>IMPORTANT!</b> Before starting installation, ensure that the power supply voltage and the rated voltage of the camera are identical.
	12 V DC, barrel connector, 5.5 x 2.1 mm 

The cameras require a 12 V DC power supply. The polarity of the DC voltage supply must be observed!

### 5.4. Connecting the video cable

In order to transmit the HD-TVI video signal from the camera to a recorder, an RG59 type coaxial cable with BNC connector (male) must be connected to the connection labelled 'TVI'. The cable length to the next device must not exceed 500 m.

	To ensure optimum quality of the HD-TVI signal transmission, it is important that the cable is neither kinked nor crushed at any point, and that its radius is adequate (min. bending radius 6 cm). Damage to the cable or porosity as a result of ageing can have a negative impact on the quality of the signal or image (e.g. shadowing around the edges).
---	--



## 6. On-screen display

### 6.1. Opening the on-screen display

This camera's on-screen display can only be opened via the ABUS HD-TVI DVR (including ZOOM/FOCUS). Please consult the user manual for the ABUS HD-TVI DVR.

### 6.2. Description of the on-screen display

Pressing the on-screen display control button opens the on-screen display. This on-screen display allows you to adjust a number of detailed settings.

#### MAIN MENU

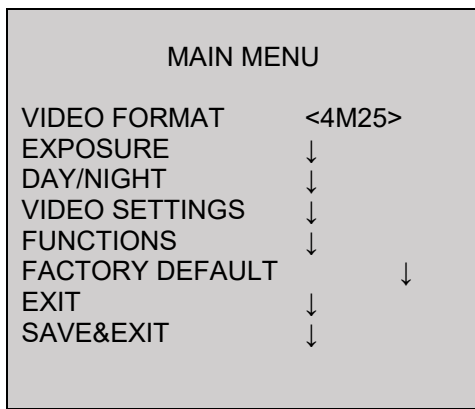

#### Video Format

Function	Description
Video Format	Video resolution setting  Options: 5M20: 5 megapixel @ 20 frames per second 4M25: 4 megapixel @ 25 frames per second (standard) 4M30: 4 megapixel @ 30 frames per second 2M25: 2 megapixel @ 25 frames per second 2M30: 2 megapixel @ 30 frames per second

## Exposure

This menu item allows you to adjust general exposure settings, e.g. whether the camera should process high contrasts or whether the camera requires special settings for night vision.

Function	Description
Exposure Mode	<p>Global: General automatic exposure setting without WDR function</p> <p>BLC: Automatic exposure setting with backlight compensation. The BLC function enhances the image display in the event of medium image contrast levels.</p> <p>WDR: Automatic exposure setting with WDR function (wide dynamic range). The WDR function enables improved display of high image contrasts. This function also has a four-step setting for adjusting to the respective contrast conditions.</p>
AGC	<p>Automatic gain control. As the setting is increased, the video image appears lighter in poor lighting conditions, although the higher the setting the higher the image noise.</p> <p>Low: Low Medium: Medium High: High</p>
Back	Return to previous menu screen
Exit	Exit the menu
Save&Exit	Save and exit the menu

## DAY NIGHT

This menu item allows you to set the mode for day/night switching.

Function	Description
Auto	<p>Automatic activation/deactivation of day mode or night mode. The integrated photo sensor controls the switchover according to the lighting level.</p> <p>IR Light: On: IR LEDs activated in night mode Off: IR LEDs deactivated in night mode</p> <p>Smart IR: Function for reducing overexposure of IR light when objects are close by On: Function activated Off: Function deactivated</p> <p>D-&gt;N Threshold (1-9): Switching threshold from day to night mode N-&gt;D Threshold (1-9): Switching threshold from night to day mode Back: Return to previous menu screen</p>
Colour	The camera stays in colour mode permanently. The infrared cut filter is constantly in front of the lens, and the IR LEDs are constantly off.
B&W	<p>The camera stays in black/white mode permanently. The infrared cut filter is constantly separated from the lens. The IR LEDs are switched on and off automatically by the photo sensor.</p> <p>IR Light: On: IR LEDs activated in night mode Off: IR LEDs deactivated in night mode</p> <p>Smart IR: Function for reducing overexposure of IR light</p>

	when objects are close by On: Function activated Off: Function deactivated
--	--

## Video Settings

This menu item allows you to adjust general image settings, such as contrast or video image mirroring.

Function	Description
Image Mode	Two basic settings of the camera can be adjusted here. STD: Standard setting HIGH-SAT: Setting for more intense colour in the image
White Balance	Auto: Automatic white balance  Manual: Manual white balance R Gain: Gain factor for proportion of red in image B Gain: Gain factor for proportion of blue in image  Back: Return to previous menu screen Exit: Exit the menu Save&Exit: Save and exit the menu
Brightness	(1–9) image brightness settings
Contrast	(1–9) Image contrast setting
Sharpness	(1–9) This function allows image sharpness perception to be adjusted electronically.
Saturation	(1–9) Saturation of the video image
3DNR	(1–9) Noise reduction function setting. The higher the value set, the more noise will be removed from the video image by the software.
Mirror	Mirroring of the video image  Off: Deactivated HV: Horizontal and vertical image mirroring (standard) V: Vertical image mirroring H: Horizontal image mirroring
Back	Return to previous menu screen
Exit	Exit the menu
Save&Exit	Save and exit the menu

## Functions

Function	Description
Motion Det	In-camera motion detection (not used)  Please use the motion detection function in HDCC video recorder.
Privacy	Privacy masking settings. A maximum of four private zones may be freely defined in terms of size and position.  MODE:           OFF: Private zone function deactivated ON: Privacy masking active AREA NO 0–3: Setting for the individual mask DISPLAY:       OFF: The mask is not displayed ON: The mask is displayed. X POSITION:     Horizontal starting position of the mask Y POSITION:     Vertical starting position of the mask WIDTH:         Horizontal size of the mask HEIGHT:        Vertical size of the mask  COLOUR:        Setting for the colour of all masks TRANSPARENCY: OFF: All masks are displayed as non-transparent. ON: All masks are displayed as slightly transparent, i.e. the underlying image area is partially displayed.
Back	Return to previous menu screen
Exit	Exit the menu
Save&Exit	Save and exit the menu

## Factory Default (Reset)

Function	Description
Factory Default	Reset all camera settings in the main menu to the factory settings  IRIS+     Confirm process (NVR PTZ menu) Cancel    Cancel process

## Back

Function	Description
Back	Return to previous menu screen

## Save&Exit

Function	Description
Save&Exit	Save all settings and exit the on-screen display

## 7. Maintenance and cleaning

### 7.1. Maintenance

Regularly check the technical safety of the product, e.g. check the housing for damage.

If it appears to no longer be possible to operate the product safely, stop using it and secure it to prevent unintentional use.

It is likely that safe operation is no longer possible in the event that:

- the device shows signs of visible damage,
- the device no longer works correctly

	<p><b>Please note:</b></p> <p>You do not need to perform any maintenance on the product. There are no components to service and nothing inside the product to check. Never open it.</p>
---	---

### 7.2. Cleaning

Clean the product with a clean, dry cloth. The cloth can be dampened with lukewarm water to remove stubborn dirt.

	<p>Do not allow any liquids to enter the device. Do not use any chemical cleaning products, as they could damage the surface of the housing and screen (discolouration).</p>
---	--

## 8. Disposal

	<p>Important: EU Directive 2002/96/EC regulates the proper return, treatment and recycling of used electronic devices. This symbol means that, in the interest of environmental protection, the device must be disposed of separately from household or industrial waste at the end of its lifespan in accordance with applicable local legal guidelines. Used devices can be disposed of at official recycling centres in your country. Obey local regulations when disposing of material. Further details on returns (also for non-EU countries) can be obtained from your local authority. Separate collection and recycling conserve natural resources and ensure that all the provisions for protecting health and the environment are observed when recycling the product.</p>
---	--

## HDCC35500



## Manuel d'utilisation

Version 02/2019



*Traduction française du manuel original allemand. À conserver pour une utilisation ultérieure.*

## Introduction

Chère cliente, cher client,

Nous vous remercions d'avoir choisi ce produit.

L'appareil est conforme aux exigences des directives européennes suivantes : directive CEM 2014/30/UE et directive RoHS 2011/65/UE.

Lorsque vous utilisez ce produit, respectez les consignes du manuel d'utilisation afin de ne pas altérer la conformité du produit et sa sécurité de fonctionnement.

Avant la mise en service du produit, veuillez lire le manuel d'utilisation dans son intégralité et respecter toutes les consignes d'utilisation et de sécurité.

**Tous les noms de sociétés et de produits mentionnés dans ce manuel sont des marques déposées de leurs propriétaires respectifs. Tous droits réservés.**

**Pour toute question, adressez-vous à votre installateur ou revendeur spécialisé.**



### Clause de non-responsabilité



Ce manuel d'utilisation a été rédigé avec le plus grand soin. Si vous constatez malgré tout des omissions ou autres imprécisions, nous vous prions de bien vouloir nous les signaler par écrit à l'adresse indiquée au dos de ce manuel.

La société ABUS Security-Center GmbH & Co. KG décline toute responsabilité en cas d'erreurs techniques ou typographiques et se réserve le droit de modifier à tout moment le produit et le manuel d'utilisateur sans préavis.



ABUS Security-Center ne peut être tenu responsable des dommages consécutifs, directs ou indirects, liés à l'équipement, aux performances et à l'utilisation de ce produit.

Le contenu de ce document ne fait l'objet d'aucune garantie.

## Signification des pictogrammes

	Le pictogramme représentant un éclair dans un triangle est utilisé en cas de danger pour la santé, par exemple risque d'électrocution.
	Le pictogramme représentant un point d'exclamation dans un triangle indique la présence, dans ce manuel d'utilisation, d'instructions importantes devant être impérativement respectées.
	Ce pictogramme indique la présence de conseils et de remarques spécifiques relatives à l'utilisation.

## Consignes de sécurité importantes

	En cas de dommages consécutifs au non-respect de ce manuel d'utilisation, la garantie devient caduque. Nous déclinons toute responsabilité pour les dommages consécutifs !
	Nous déclinons toute responsabilité pour les dommages matériels et/ou corporels résultant d'une manipulation non conforme ou du non-respect des consignes de sécurité. Dans de tels cas, la garantie devient caduque !

**Chère cliente, cher client, les remarques relatives à la sécurité et mises en garde suivantes sont destinées à la protection de votre santé ainsi qu'à la protection de l'appareil. Veuillez lire attentivement les points suivants :**

- Ce produit ne contient aucune pièce nécessitant un entretien. Par ailleurs, tout démontage du produit entraînera automatiquement l'annulation de la certification (CE) et de la garantie.
- Une chute, même de faible hauteur, risque d'endommager le produit.
- Installez le produit de manière à ce que l'enregistreur d'images de l'appareil ne soit pas directement exposé aux rayons du soleil. Veuillez respecter les consignes de montage mentionnées au chapitre correspondant de ce manuel.
- L'appareil a été conçu pour une utilisation à l'intérieur et à l'extérieur (IP67).

Évitez d'utiliser l'appareil dans les conditions ambiantes défavorables suivantes :

- lieu humide ou humidité élevée de l'air ;
- froid ou chaleur extrême ;
- exposition directe aux rayons du soleil ;
- poussières ou gaz, vapeurs ou solvants inflammables ;
- fortes vibrations ;
- champs magnétiques intenses, comme à proximité de machines ou de haut-parleurs.
- Il est interdit d'installer la caméra sur des surfaces instables.

Consignes de sécurité générales :

- Ne laissez pas traîner le matériel d'emballage. Dans les mains d'un enfant, les films et sacs en plastique, les éléments en polystyrène, etc. peuvent devenir des jouets dangereux.
- Pour des raisons de sécurité, la caméra de vidéosurveillance doit être tenue hors de la portée des enfants en raison des petites pièces qu'ils pourraient avaler.
- N'introduisez jamais d'objets à travers les ouvertures de l'appareil.
- Utilisez uniquement les appareils auxiliaires/accessoires préconisés par le fabricant. Ne raccordez pas de produits incompatibles.
- Veuillez respecter les consignes de sécurité et les manuels d'utilisateur des autres appareils raccordés.
- Avant de mettre l'appareil en service, vérifiez qu'il n'est pas endommagé. En cas de dommages, ne mettez pas l'appareil en service !
- Respectez les limites de la tension de service indiquées dans les caractéristiques techniques. Toute tension supérieure est susceptible d'endommager l'appareil et de compromettre votre sécurité (risque d'électrocution).





**Consignes de sécurité**

1. Alimentation électrique : Tenez compte des informations mentionnées sur la plaque signalétique concernant l'alimentation électrique et la consommation de courant.
2. Surcharge  
Évitez toute surcharge des prises secteur, des rallonges de câble et des adaptateurs, ceci pouvant entraîner un risque d'électrocution ou d'incendie.
3. Nettoyage  
Nettoyez l'appareil uniquement avec un chiffon humide et n'utilisez pas de produits de nettoyage agressifs.  
Pour cela, déconnectez l'alimentation électrique de l'appareil.

**Avertissements**

Avant la première mise en service, vous devez avoir lu toutes les consignes de sécurité et d'utilisation et veiller à leur respect !

1. Respectez les consignes suivantes pour ne pas endommager le câble et la prise secteur :
  - Pour déconnecter l'appareil du secteur, retirez-le de la prise secteur sans tirer sur le câble secteur.
  - Veillez à ce que le câble secteur se trouve le plus loin possible de tout appareil de chauffage afin que la gaine en plastique du câble ne puisse pas fondre.
2. Suivez attentivement ces instructions. Leur non-respect pourrait provoquer une électrocution :
  - N'ouvrez jamais le boîtier ou le bloc d'alimentation.
  - N'introduisez aucun objet métallique ou inflammable à l'intérieur de l'appareil.
  - Pour éviter les dommages dus à des surtensions (en cas de foudre par exemple), veuillez utiliser une protection contre les surtensions.
3. Lorsqu'un appareil tombe en panne, déconnectez-le immédiatement du secteur et signalez la panne à votre revendeur.

	Avant d'installer l'appareil dans un système de vidéosurveillance existant, veillez à ce que tous les appareils soient déconnectés du circuit secteur et du circuit basse tension.
	En cas de doute, ne procédez pas vous-même au montage, à l'installation et au câblage, mais confiez-les à un professionnel qualifié. Toute intervention mal exécutée et réalisée par un non-professionnel sur le réseau électrique ou sur les installations domestiques peut être dangereuse, pour vous-même et pour autrui. Les installations doivent être câblées de façon à ce que le circuit secteur et le circuit basse tension soient toujours séparés. Ils ne doivent en aucun cas être reliés ou pouvoir être reliés suite à un défaut.

**Déballage**

Veuillez manipuler l'appareil avec la plus grande précaution lorsque vous le retirez de l'emballage.

	Si l'emballage d'origine est endommagé, examinez tout d'abord l'appareil. Si ce dernier a subi des dommages, veuillez le renvoyer avec son emballage et en informer le service de livraison.
---	--



**Table des matières**

- 1. Utilisation conforme ..... 34**
- 2. Étendue de la livraison..... 34**
- 3. Caractéristiques et fonctions ..... 34**
- 4. Description de la caméra ..... 35**
- 5. Montage/Installation ..... 35**
  - 5.1. Montage de la caméra ..... 35
  - 5.2. Orientation de la caméra..... 36
  - 5.3. Alimentation électrique..... 37
  - 5.4. Installation du câble vidéo..... 37
- 6. Menu d'affichage à l'écran..... 38**
  - 6.1. Ouverture du menu d'affichage à l'écran ..... 38
  - 6.2. Description du menu d'affichage à l'écran ..... 38
- 7. Maintenance et nettoyage ..... 41**
  - 7.1. Maintenance..... 41
  - 7.2. Nettoyage..... 41
- 8. Élimination ..... 41**

**1. Utilisation conforme**

Cette caméra convient tant au fonctionnement de jour que de nuit. Elle fournit des images vidéo en résolution Full-HD et le signal de sortie est disponible au format HD-TVI. Ceci permet d'utiliser des câbles coaxiaux classiques pour la transmission des signaux. Elle permet la vidéosurveillance en association avec un enregistreur. L'appareil a été conçu pour une utilisation à l'intérieur et à l'extérieur.

**2. Étendue de la livraison**

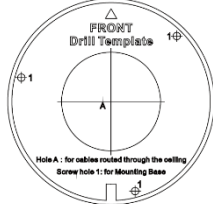
	
<p>Mini-dôme IR HD-TVI extérieur</p>	<p>Consignes de sécurité</p>
	
<p>Outil d'installation</p>	<p>Gabarit de perçage</p>

**3. Caractéristiques et fonctions**

- Résolution de 5 mégapixels : 2560 x 1944 à 20 fps
- Transmission via l'infrastructure CCTV classique (jusqu'à 500 mètres via un câble RG59)
- Objectif fixe 2.8 mm
- Sortie vidéo 4 en 1 (commutable TVI / AHD / CVI / CVBS)
- LED IR pour vision nocturne
- 3D DNR pour des images sans bruit
- Fonction True WDR permettant d'équilibrer les contrastes de l'image (120 dB)
- Boîtier résistant aux intempéries (IP67)
- Menu d'affichage à l'écran pour la configuration de la caméra (commande par DVR via un câble coaxial)

4. Description de la caméra

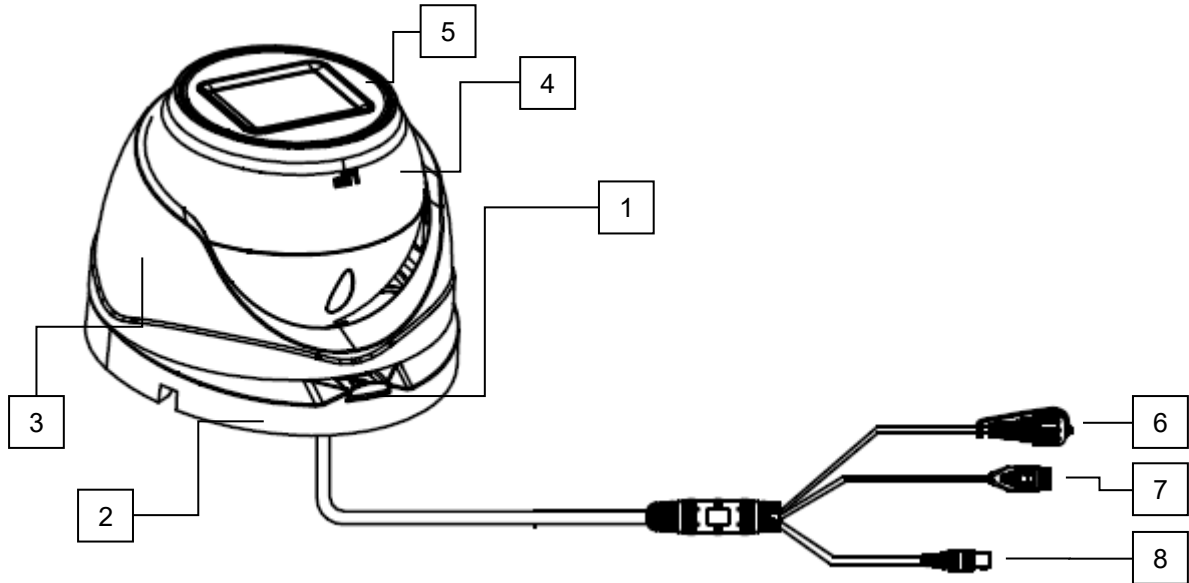

1	Élément de fixation avec vis de fixation
2	Plaque de fond de la caméra
3	Capuchon de la caméra
4	Tête de caméra
5	LED IR
6	Bouton pour basculer entre différents formats vidéo: TVI / AHD / CVI / CVBS Cette fonction est uniquement disponible dans les résolutions 4M @ 25fps et 4M30fps (maintenez les boutons enfoncés pendant plus de 3 secondes).
7	Raccordement électrique (5,5 x 2,1 mm, fiche creuse) 
8	Sortie vidéo (BNC, inscription "TVI")

5. Montage/Installation

5.1. Montage de la caméra

	<p><b>ATTENTION !</b> Pendant le montage, la caméra doit être coupée de l'alimentation secteur.</p>
--	---

Desserrez la vis de fixation de la plaque de fond de la caméra et retirez-la. Utilisez le gabarit de perçage fourni pour percer les trous de fixation.

Si les câbles doivent être posés latéralement, introduisez d'abord le câble de raccordement à travers la plaque de fond et l'ouverture latérale de la plaque de fond.

Fixez maintenant la plaque de fond.

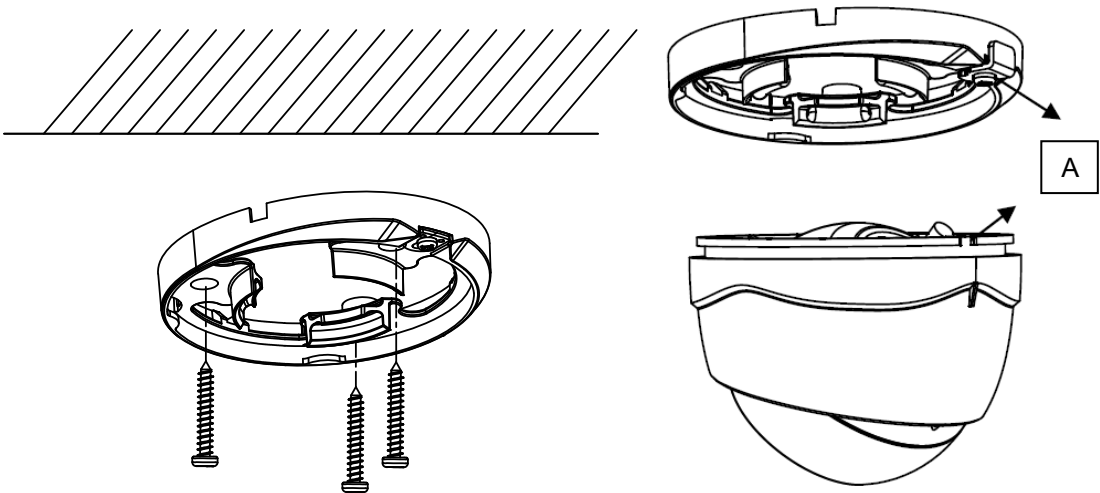

Fixez ensuite la tête de caméra en posant le capuchon de caméra. L'anneau de réglage dispose pour cela d'un emplacement avec une encoche (A) dans laquelle l'élément de fixation peut être inséré dans l'anneau de réglage. Serrez légèrement la vis de fixation du capuchon de la caméra pour pouvoir ensuite orienter la caméra.



5.2. Orientation de la caméra

Au besoin, desserrez la vis de fixation de la plaque de fond de la caméra. L'orientation de la pièce centrale de la caméra peut maintenant être réglée sur 3 axes. Resserrez la vis de fixation.

	(A) Inclinaison	90°
	(B) Pivotement	360°
	(C) Rotation	360°

La portée IR effective varie selon le lieu d'installation. Les surfaces absorbant la lumière ou l'absence d'objets réfléchissant la lumière IR dans l'angle de visée réduisent la portée IR et provoquent des images vidéos trop sombres. Par ailleurs, les objets réfléchissants situés à proximité immédiate de la caméra (gouttière, mur) peuvent faire réfléchir la lumière IR de manière gênante dans l'image. Sur les modèles HDCC35500, veillez à ce que les LED IR ne soient pas cachées par le capuchon de la caméra car des réflexions peuvent en résulter.

### 5.3. Alimentation électrique

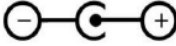
	<p><b>ATTENTION !</b> Avant de commencer l'installation, assurez-vous que l'alimentation électrique correspond bien à la tension nominale de la caméra.</p>
	<p>12 V CC, fiche creuse, 5,5 x 2,1 mm</p> 

Les caméras exigent une alimentation électrique 12 V CC. Tenez compte de la polarité de l'alimentation en courant continu.

### 5.4. Installation du câble vidéo

Pour transmettre le signal vidéo HD-TVI de la caméra à un enregistreur, un câble coaxial de type RG59 à connecteur BNC (mâle) doit être branché au connecteur « TVI ». La longueur du câble jusqu'au prochain appareil ne doit pas dépasser 500 m.

	<p>Pour garantir la qualité parfaite de la transmission du signal HD-TVI, il est nécessaire que le câble ne soit ni coudé, ni écrasé, ni posé selon un rayon trop faible (rayon de courbure min. 6 cm). Si le câble est endommagé ou devient poreux à cause de son ancienneté, ceci peut avoir des conséquences sur la qualité du signal et de l'image (par ex. formation d'ombre sur les contours).</p>
---	--

## 6. Menu d'affichage à l'écran

### 6.1. Ouverture du menu d'affichage à l'écran

Le menu d'affichage à l'écran de cette caméra est accessible uniquement avec l'ABUS HD-TVI DVR (avec ZOOM/FOCUS). Pour cela, consultez le manuel d'utilisateur de l'ABUS HD-TVI DVR.

### 6.2. Description du menu d'affichage à l'écran

Appuyez sur le bouton de la commande du menu d'affichage à l'écran pour ouvrir le menu d'affichage à l'écran. Ce menu permet d'effectuer des réglages précis.

#### MENU PRINCIPAL

MAIN MENU	
VIDEO FORMAT	<4M25>
EXPOSURE	↓
DAY/NIGHT	↓
VIDEO SETTINGS	↓
FUNCTIONS	↓
FACTORY DEFAULT	↓
EXIT	↓
SAVE&EXIT	↓

#### Video Format

Fonction	Description
Video Format	Réglage de la résolution vidéo  Options : 5M20 : 5 mégapixels @ 20 images/s 4M25 : 4 mégapixels @ 25 images/s (standard) 4M30 : 4 mégapixels @ 30 images/s 2M25 : 2 mégapixels @ 25 images/s 2M30 : 2 mégapixels @ 30 images/s

## Exposure

Ce menu contient les réglages généraux de l'exposition. Il est utile si la caméra doit traiter des contrastes importants ou si elle exige des réglages spécifiques pour la vision nocturne.

Fonction	Description
Exposure Mode	<p>Global : Réglage général automatique de l'exposition sans la fonction WDR</p> <p>BLC : Réglage automatique de l'exposition avec compensation de contre-jour (Back Light Compensation). La fonction BLC permet un meilleur rendu des images moyennement contrastées.</p> <p>WDR : Réglage automatique de l'exposition avec la fonction WDR (Wide Dynamic Range). La fonction WDR permet un meilleur rendu des images fortement contrastées. Cette fonction dispose également d'un réglage en 4 étapes pour s'adapter aux rapports de contraste donnés.</p>
AGC	<p>Contrôle automatique du gain. Plus le réglage est élevé, plus l'image vidéo est claire dans des conditions d'éclairage médiocres, mais les bruits d'image sont aussi plus importants.</p> <p>Low : Faible            Medium : Moyen            High : Élevée</p>
Back	Retour à la page de menu précédente
Exit	Quitter le menu
Save&Exit	Enregistrer et quitter le menu

## DAY NIGHT

Ce menu permet de régler la commutation jour/nuit.

Fonction	Description
Auto	<p>Activation/Désactivation automatiques du mode jour ou nuit. Le capteur photo intégré commande la commutation selon l'intensité d'éclairage.</p> <p>IR Light : On : IR LED actives en mode nuit            Off : LED IR inactives en mode nuit</p> <p>Smart IR : Fonction permettant la réduction de la surexposition de la lumière IR pour les objets proches            On : fonction activée            Off : fonction désactivée</p> <p>D -&gt; N Threshold (1-9) :Seuil de commutation du jour à la nuit            N -&gt; D Threshold (1-9) :Seuil de commutation de la nuit au jour            Back : Retour à la page de menu précédente</p>
Color	La caméra reste en mode couleur. Le filtre pivotant infrarouge reste devant l'objectif et les LED IR restent éteintes.
B&W	La caméra reste en mode noir/blanc. Le filtre pivotant infrarouge est retiré de l'objectif. Les LED IR sont automatiquement allumées et éteintes par le capteur photo.



	IR Light :            On : IR LED actives en mode nuit Off : LED IR inactives en mode nuit Smart IR :            Fonction permettant la réduction de la surexposition de la lumière IR pour les objets proches On : fonction activée Off : fonction désactivée
--	--

**Video Settings**

Ce menu permet d'effectuer des réglages généraux de l'image, comme le contraste ou l'inversion de l'image vidéo.

Fonction	Description
Mode image	Sous cette option, 2 réglages de base de la caméra sont disponibles. STD :            réglage standard HIGH-SAT :    pour une image aux couleurs plus intenses
White Balance	Auto :            Balance des blancs automatique  Manual :        Balance des blancs manuelle R Gain :Facteur de gain de la composante rouge de l'image B Gain :Facteur de gain de la composante bleue de l'image  Back :            Retour à la page de menu précédente Exit :            Quitter le menu Save&Exit :    Enregistrer et quitter le menu
Brightness	(1~9) :          réglage de la luminosité des images
Contrast	(1~9) :          Réglage du contraste de l'image
Sharpness	(1~9) :          Cette fonction permet de modifier électroniquement la perception de la netteté de l'image.
Saturation	(1~9) :          Saturation de l'image vidéo
3DNR	(1~9) :          Réglage de la fonction d'élimination des bruits parasites. Plus la valeur est élevée, plus le logiciel élimine de bruits dans l'image vidéo.
Mirror	Inversion de l'image vidéo  Off :            Désactivé HV :            Inversion de l'image horizontale et de l'image verticale (standard) V :            Inversion de l'image verticale H :            Inversion de l'image horizontale
Back	Retour à la page de menu précédente
Exit	Quitter le menu
Save&Exit	Enregistrer et quitter le menu

## 7. Maintenance et nettoyage

### 7.1. Maintenance

Contrôlez régulièrement la sécurité technique du produit par ex., l'état du boîtier.

Si vous constatez que le produit ne peut plus être utilisé en toute sécurité, mettez-le hors service et empêchez une remise en service involontaire.

La sécurité d'utilisation du produit n'est plus garantie si

- l'appareil présente des dommages visibles ;
- l'appareil ne fonctionne plus.

	<p><b>Remarque :</b></p> <p>Le produit ne nécessite aucune maintenance de votre part. Aucune des pièces à l'intérieur de ce produit ne nécessite de maintenance ou de contrôle de votre part. N'ouvrez jamais le produit.</p>
---	---

### 7.2. Nettoyage

Nettoyez le produit avec un chiffon propre et sec. En cas d'encrassement plus important, humidifiez légèrement le chiffon avec de l'eau tiède.

	<p>Veillez à ce qu'aucun liquide ne pénètre à l'intérieur de l'appareil. N'utilisez pas de produits nettoyants chimiques, car cela risquerait d'endommager la surface du boîtier et de l'écran (décoloration).</p>
---	--

## 8. Élimination

	<p>Attention : la directive européenne 2002/96/CE régit la reprise, le traitement et le recyclage des appareils électroniques usagés. Ce symbole signifie que, dans un souci de protection de l'environnement, l'appareil en fin de vie ne doit pas être éliminé avec les ordures ménagères ou industrielles, mais recyclé conformément aux dispositions légales en vigueur. Le recyclage de votre appareil usagé peut être assuré par les organismes officiels de collecte présents dans votre pays. Respectez les prescriptions locales pour l'élimination des matériaux. Vous obtiendrez de plus amples informations concernant la collecte (y compris pour les pays ne faisant pas partie de l'Union européenne) auprès des administrations locales. Le tri et le recyclage permettent de préserver les ressources naturelles et de respecter les règles de protection de la santé et de l'environnement.</p>
---	---

## HDCC35500



## Gebruikershandleiding

Versie 02/2019



*Nederlandse vertaling van de originele Duitse handleiding. Bewaren voor toekomstig gebruik!*

## Inleiding

Geachte klant,

Hartelijk dank voor de aankoop van dit product.

Het apparaat voldoet aan de eisen van de volgende EU-richtlijnen: EMC-richtlijn 2014/30/EU en RoHS-richtlijn 2011/65/EU.

Om deze toestand te behouden en een veilig gebruik te garanderen, dient u als gebruiker deze gebruikershandleiding in acht te nemen!

Lees de complete gebruikershandleiding door voordat u het product in gebruik neemt. Neem alle gebruiks- en veiligheidsinstructies in acht!

**Alle genoemde bedrijfs- en productnamen zijn handelsmerken van de betreffende eigenaren. Alle rechten voorbehouden.**

**Neem bij vragen contact op met uw installateur of speciaalzaak!**



### **Uitsluiting van aansprakelijkheid**



Deze gebruikershandleiding is met grote zorgvuldigheid opgesteld. Mocht u toch weglatingen of onnauwkeurigheden ontdekken, informeer ons dan schriftelijk hierover via het adres op de achterkant van de handleiding.

ABUS Security-Center GmbH & Co. KG aanvaardt geen enkele aansprakelijkheid voor technische en typografische fouten en behoudt zich het recht voor te allen tijde, zonder aankondiging vooraf, wijzigingen aan het product en in de gebruikershandleidingen door te voeren.



ABUS Security-Center is niet aansprakelijk of verantwoordelijk voor directe en indirecte gevolgschade die in verband met de uitrusting, de prestatie en het gebruik van dit product ontstaan.

Voor de inhoud van dit document wordt geen enkele garantie gegeven.

## Verklaring van symbolen

	Het symbool met de bliksemschicht in de driehoek wordt gebruikt als er gevaar voor de gezondheid bestaat, bijv. door een elektrische schok.
	Een driehoek met uitroepetekens wijst op belangrijke instructies in deze gebruikershandleiding die altijd in acht genomen moeten worden.
	Dit symbool wijst op bijzondere tips en instructies over de bediening.

## Belangrijke veiligheidsinstructies

	<b>Bij schade die door het niet in acht nemen van deze gebruikershandleiding wordt veroorzaakt, vervalt de aanspraak op garantie. Wij aanvaarden geen aansprakelijkheid voor gevolgschade!</b>
	<b>Wij aanvaarden geen aansprakelijkheid voor materiële schade of letselschade, die door onjuist gebruik of het niet in acht nemen van de veiligheidsinstructies is veroorzaakt. In deze gevallen vervalt ieder recht op garantie!</b>

**Geachte klant, de volgende veiligheids- en gevareninstructies dienen niet alleen ter bescherming van uw gezondheid, maar zijn ook bedoeld voor de bescherming van het apparaat. Lees de volgende punten aandachtig door:**

- Binnen in het product bevinden zich geen onderdelen die onderhouden moeten worden. Bovendien vervalt de vergunning (CE) en de garantie/vrijwaring door het demonteren.
- Het product kan al beschadigd raken door een val van slechts geringe hoogte.
- Monteer het product zo, dat direct zonlicht niet op de beeldopnemer van het apparaat kan vallen. Neem de montage-instructies in het betreffende hoofdstuk van deze gebruikershandleiding in acht.
- Het apparaat is voor het gebruik binnen en buiten (IP67) ontworpen.

Vermijd bij gebruik de volgende ongunstige omgevingsomstandigheden:

- Vocht of te hoge luchtvochtigheid
- extreme kou of hitte
- direct zonlicht
- stof of brandbare gassen, dampen of oplosmiddelen
- sterke trillingen
- sterke magneetvelden, bijvoorbeeld in de buurt van machines of luidsprekers.
- De camera mag niet op onstabiele oppervlakken worden geïnstalleerd.

Algemene veiligheidsinstructies:

- Laat het verpakkingsmateriaal niet onbeheerd achter! Plastic folie, plastic zakjes, stukken piepschuim e.d. kunnen gevaarlijk speelgoed zijn voor kinderen.
- De videobewakingscamera bevat kleine onderdelen die ingeslikt kunnen worden. Houd het apparaat daarom om veiligheidsredenen uit de buurt van kinderen.
- Steek geen voorwerpen door de openingen in het apparaat
- Gebruik alleen de hulpapparaten/hulpstukken die door de fabrikant zijn aangegeven. Sluit geen producten aan die niet compatibel zijn.
- Neem de veiligheidsinstructies en gebruikershandleidingen van de overige aangesloten apparaten in acht.
- Controleer het apparaat voor de ingebruikneming op beschadigingen. Mocht u beschadigingen ontdekken, neem het apparaat dan niet in gebruik!
- Houdt u zich aan de bedrijfsspanningsgrenzen die in de technische gegevens staan vermeld. Hogere spanningen kunnen het apparaat beschadigen en uw veiligheid in gevaar brengen (elektrische schok).



## Veiligheidsinstructies

1. Voeding: Let op de op het typeplaatje aangegeven waarden voor de voedingsspanning en het stroomverbruik.
2. Overbelasting  
Vermijd overbelasting van stopcontacten, verlengkabels en adapters. Overbelasting kan leiden tot brand of een elektrische schok.
3. Reiniging  
Reinig het apparaat alleen met een vochtige doek zonder bijtende reinigingsmiddelen.  
Het apparaat daarvoor loskoppelen van het stroomnet.

## Waarschuwingen

Voor de eerste ingebruikneming dienen alle veiligheids- en bedieningsinstructies in acht te worden genomen!

1. Neem de volgende instructies in acht om schade aan netsnoeren en netstekkers te vermijden:
  - Als u het apparaat van het stroomnet loskoppelt, trek dan niet aan het netsnoer, maar aan de stekker.
  - Let op dat het netsnoer zo ver mogelijk van verwarmingsapparatuur verwijderd is om te verhinderen dat het kunststof omhulsel smelt.
2. Volg deze instructies op. Bij niet-naleving van de instructies kan er een elektrische schok optreden:
  - Open nooit de behuizing of de netstekkervoeding.
  - Steek geen metalen of licht ontvlambare voorwerpen in het apparaat.
  - Om beschadigingen door overspanning (bijv. onweer) te vermijden, dient u een overspanningsbeveiliging te gebruiken.
3. Koppel defecte apparaten direct los van het elektriciteitsnet en informeer uw specialzaak.

	Zorg er bij installatie in een bestaande videobewakingsinstallatie voor dat alle apparaten gescheiden zijn van net- en laagspanningsstroomkring.
	In geval van twijfel dient u de montage, installatie en bedrading niet zelf uit te voeren, maar aan een specialist over te laten. Ondeskundige en amateuristische werkzaamheden aan het elektriciteitsnet of aan de huisinstallaties zijn niet alleen gevaarlijk voor uzelf, maar ook voor anderen. Sluit de installaties zo op het stroomnet aan dat net- en laagspanningsstroomkringen altijd gescheiden verlopen en op geen enkele plaats met elkaar verbonden zijn of door een defect met elkaar verbonden kunnen worden.

## Uitpakken

Tijdens het uitpakken moet u het apparaat uiterst zorgvuldig behandelen.

	Bij een eventuele beschadiging van de originele verpakking moet u het apparaat eerst controleren. Als het apparaat is beschadigd, stuurt u het in de verpakking terug en informeert u de bezorgdienst.
---	--



## Inhoudsopgave

<b>1. Beoogd gebruik .....</b>	<b>47</b>
<b>2. Inhoud van de levering.....</b>	<b>47</b>
<b>3. Kenmerken en functies .....</b>	<b>47</b>
<b>4. Beschrijving van de camera .....</b>	<b>48</b>
<b>5. Montage / installatie .....</b>	<b>48</b>
5.1. Camera monteren .....	48
5.2. Camera uitlijnen .....	49
5.3. Voeding.....	50
5.4. Videokabel aanbrengen .....	50
<b>6. Schermmenu .....</b>	<b>51</b>
6.1. Schermmenu (OSD) openen.....	51
6.2. Beschrijving schermmenu (OSD).....	51
<b>7. Onderhoud en reiniging .....</b>	<b>55</b>
7.1. Onderhoud .....	55
7.2. Reiniging .....	55
<b>8. Afdanken .....</b>	<b>55</b>

## 1. Beoogd gebruik

Deze camera is zowel geschikt voor gebruik overdag als 's nachts. De camera levert videobeelden in Full HD-resolutie en het uitgangssignaal is beschikbaar in HD TVI-formaat. Hiermee is het gebruik van conventionele coaxkabel voor de signaaloverdracht mogelijk. De camera dient voor de videobewaking in combinatie met een opnameapparaat. Het apparaat is voor het gebruik binnen en buiten ontworpen.

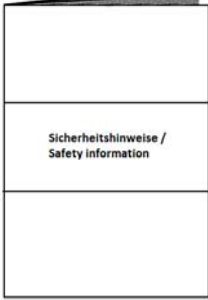
## 2. Inhoud van de levering

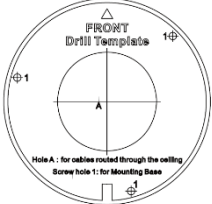
	
<p>Buiten HD-TVI Mini Dome IR</p>	<p>Veiligheidsinstructies</p>
	
<p>Installatiegereedschap</p>	<p>Boorsjabloon</p>

## 3. Kenmerken en functies

- Resolutie van 5 megapixels: 2560 x 1944 @ 20 fps
- Overdracht via conventionele CCTV-infrastructuur (tot 500 meter via RG59-kabel)
- 2.8 mm vast objectief
- 4-in-1 video-uitgang (omschakelbaar TVI / AHD / CVI / CVBS)
- IR-leds voor nachtzicht
- 3D DNR voor ruisvrije beelden
- True WDR-functie voor de vereffening van beeldcontrasten (120 dB)
- Weerbestendige camerabehuizing (IP67)
- On-screen-menu voor cameraconfiguratie (besturing met DVR via coaxkabel)



#### 4. Beschrijving van de camera

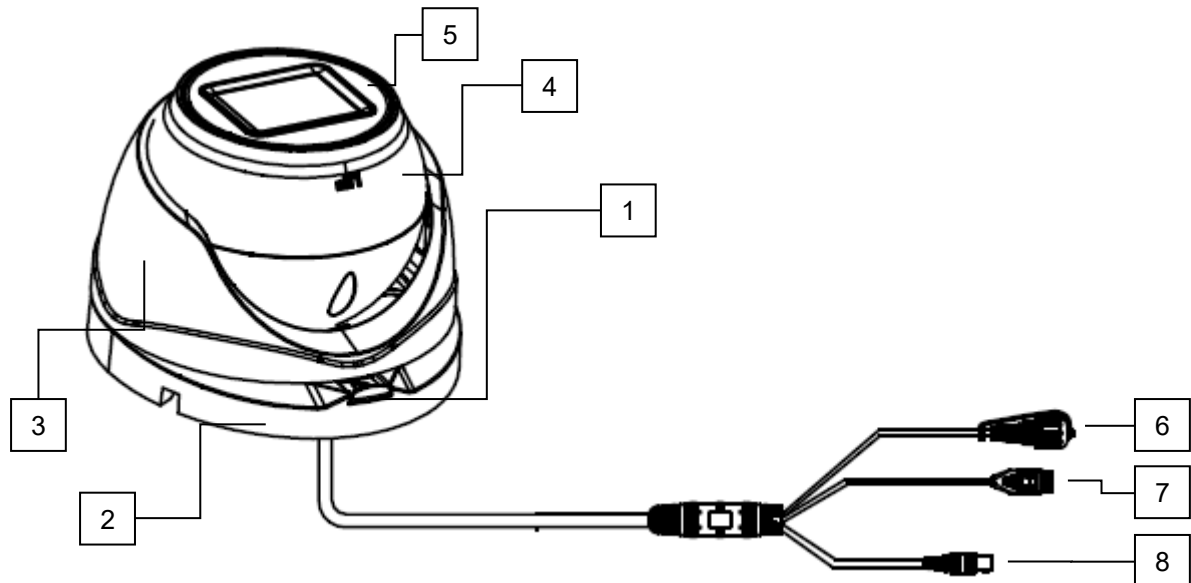

1	Borgelement met borgschroef
2	Onderplaat camera
3	Camerakap
4	Camerakop
5	IR-LED's
6	Knop om tussen verschillende videoformaten te schakelen: TVI / AHD / CVI / CVBS Deze functie is alleen beschikbaar in de resoluties van 4M @ 25fps en 4M30fps (houd de knoppen langer dan 3 seconden ingedrukt)
7	Spanningsaansluiting (5,5x2,1mm, holle stekker) 
8	Video-uitgang (BNC, opdruk 'TVI')

#### 5. Montage / installatie

##### 5.1. Camera monteren

	<p><b>LET OP!</b> Tijdens de montage moet de camera van de netspanning zijn losgekoppeld.</p>
---	---

Draai de borgschroef voor de onderplaat van de camera los en verwijder deze. Gebruik de bijgevoegde boorsjabloon voor het boren van de bevestigingsgaten.

Als de kabels vanaf de zijkant moeten worden gelegd, voert u eerst de aansluitkabel door de onderplaat en de opening aan de zijkant van de onderplaat.

Zet nu de onderplaat vast.

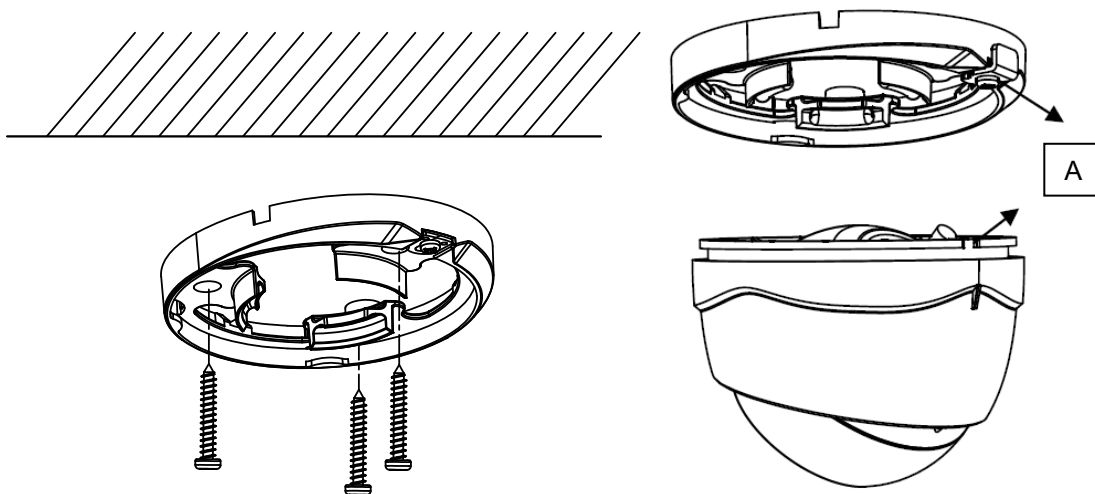

Zet daarna de camerakop vast door het plaatsen van de camerakap. De afstelring heeft daarbij een uitsparing (A) op een punt waarop het borgelement in de afstelring kan worden geleid. Draai de borgschroef voor de camerakap iets vast om daarna de richting van de camera in te stellen.



## 5.2. Camera uitlijnen

Indien nodig draait u de borgschroef aan de onderplaat van de camera los. Nu kan het middelste cameradeel in 3 assen worden ingesteld. Draai de borgschroef daarna weer vast.

	<table border="0"> <tr> <td>(A) Kantelen</td> <td>90°</td> </tr> <tr> <td>(B) Zwenken</td> <td>360°</td> </tr> <tr> <td>(C) Draaien</td> <td>360°</td> </tr> </table>	(A) Kantelen	90°	(B) Zwenken	360°	(C) Draaien	360°
(A) Kantelen	90°						
(B) Zwenken	360°						
(C) Draaien	360°						

	<p>Het effectieve IR-bereik is afhankelijk van de locatie. Licht absorberende oppervlakken of objecten die geen IR-licht reflecteren in het zicht reduceren het IR-bereik of geven een te donker videobeeld. Bovendien kunnen reflecterende objecten in de directe omgeving van de camera (dakgoot, muur) storende reflecties van IR-licht in het beeld veroorzaken. U dient erop te letten dat bij de modell HDCC35500 de IR-LED's niet worden bedekt door de camerakap, omdat er anders reflecties ontstaan.</p>
--	--

### 5.3. Voeding

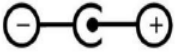
	<p><b>LET OP!</b> Voordat u aan de installatie begint, controleert u of de voedingsspanning en de nominale spanning van de camera overeenkomen.</p>
	<p>12 VDC, DC-stekker 5.5 x 2.1 mm</p> 

De camera's worden gevoed met 12 VDC-voedingsspanning. De polariteit van de gelijkspanning moet in acht worden genomen!

### 5.4. Videokabel aanbrengen

Om het HD-TVI-videosignaal van de camera naar een recorder te sturen, moet een coaxkabel van het type RG59 met BNC-stekker (male, man) op de aansluiting met de opdruk 'TVI' worden aangesloten. De kabellengte tot het volgende apparaat mag niet langer zijn dan 500 meter.

	<p>Voor een optimale kwaliteit van de overdracht van het HD TVI-signaal is het nodig dat de kabel op geen enkel punt geknikt, geklemd of in een te kleine radius wordt gelegd. (min. buigradius 6 cm). Als de kabel beschadigd of door het verouderingsproces poreus is geworden, kan dat ook gevolgen hebben voor de signaal- of beeldkwaliteit (bijvoorbeeld schaduwvorming om randen).</p>
---	---

## 6. Schermmenu

### 6.1. Schermmenu (OSD) openen

Het schermmenu (OSD, on-screen-display) van deze camera kan uitsluitend via de ABUS HD-TVI DVR worden geopend (met ZOOM/FOCUS). Lees daarvoor de gebruikershandleiding van de ABUS HD-TVI DVR.

### 6.2. Beschrijving schermmenu (OSD)

Door op de toets voor het OSD-menu Besturing te drukken opent u het OSD-schermmenu. Via dit schermmenu kunnen gedetailleerde instellingen worden aangepast.

#### HOOFDMENU

MAIN MENU	
VIDEOFORMAAT	<4M25>
EXPOSURE	↓
DAY/NIGHT	↓
VIDEO SETTINGS	↓
FUNCTIONS	↓
FACTORY DEFAULT	↓
EXIT	↓
SAVE&EXIT	↓

#### Video Format

Functie	Beschrijving
Video Format	<p>Instelling voor de videoresolutie</p> <p>Opties:</p> <p>5M20: 5 megapixels @ 20 beelden/s</p> <p>4M25: 4 megapixels @ 25 beelden/s (standaard)</p> <p>4M30: 4 megapixels @ 30 beelden/s</p> <p>2M25: 2 megapixels @ 25 beelden/s</p> <p>2M30: 2 megapixel @ 30 beelden/s</p>

## Exposure

In dit menupunt worden algemene belichtingsinstellingen aangepast, bijvoorbeeld of de camera hoge contrasten verwerken moet of dat de camera speciale instellingen voor nachtzicht nodig heeft.

Functie	Beschrijving
Exposure Mode	<p>Global: Algemene automatische belichtingsinstelling zonder WDR-functie</p> <p>BLC: Automatische belichtingsinstelling met tegenlichtcompensatie (Back Light Compensation). De BLC-functie verbetert de beeldweergave bij gemiddelde beeldcontrasten.</p> <p>WDR: Automatische belichtingsinstelling met WDR-functie (Wide Dynamic Range). De WDR-functie wordt gebruikt om de weergave van hoge beeldcontrasten te verbeteren. Deze functie beschikt bovendien over een 4-traps instelling voor de aanpassing aan de gegeven contrastverhoudingen.</p>
AGC	<p>Automatische versterkingsregeling. Hoe hoger de instelling, hoe helderder het videobeeld wordt weergegeven bij lage belichting, de beeldruis wordt echter ook hoger.</p> <p>Low: Laag Medium: Gemiddeld High: Hoog</p>
Back	Terug naar vorige menupagina
Exit	Het menu verlaten
Save&Exit	Opslaan en verlaten van het menu

## DAY NIGHT

In dit menupunt wordt de modus voor de dag-/nachtschakeling ingesteld.

Functie	Beschrijving
Auto	<p>Automatische activering/deactivering van de dag- of nachtmodus. De geïntegreerde lichtsensor stuurt de omschakeling afhankelijk van verlichtingssterkte.</p> <p>IR Light: On: IR-led's in nachtmodus actief Off: IR-LED's in nachtmodus niet-actief</p> <p>Smart IR: Functies voor de reductie van overstraling van het IR-licht bij dichtbij gelegen objecten On: Functie actief Off: functie inactief</p> <p>D-&gt;N Threshold (1-9): Omschakeldrempel van dag- naar nachtmodus</p> <p>N-&gt;D Threshold (1-9): Omschakeldrempels van nacht- naar dagmodus</p> <p>Back: Terug naar vorige menupagina</p>
Color	De camera blijft altijd in kleurenmodus staan. Het infrarood-draaifilter blijft altijd vóór het objectief en de IR-LED's zijn altijd uit.
B&W	De camera blijft altijd in zwart/wit-modus staan. Het zwenkfilter is permanent gescheiden van het objectief. De IR-LED's worden automatisch door de lichtsensor in- en uitgeschakeld.

	<p>IR Light: On: IR-led's in nachtmodus actief Off: IR-LED's in nachtmodus niet-actief</p> <p>Smart IR: Functies voor de reductie van overstraling van het IR-licht bij dichtbij gelegen objecten On: Functie actief Off: functie inactief</p>
--	--

## Video Settings

In dit menupunt worden algemene beeldinstellingen zoals contrast of spiegeling van het videobeeld aangepast.

Functie	Beschrijving
Image-modus	Op dit punt zijn 2 verschillende basisinstellingen van de camera instelbaar. STD: Standaardinstelling HIGH-SAT: Instelling voor een intenser beeld qua kleur
White Balance	Auto: Automatische witbalans  Manual: Handmatige witbalans R Gain: Versterkingsfactor voor het roodaandeel in het beeld B Gain: Versterkingsfactor voor het blauwaandeel in het beeld  Back: Terug naar vorige menupagina Exit: Het menu verlaten Save&Exit: Opslaan en verlaten van het menu
Brightness	(1~9): Instelling voor de beeldhelderheid
Contrast	(1~9): Instellingen voor het beeldcontrast
Sharpness	(1~9): Met deze functie kan elektronisch de waarneming van de beeldscherpte worden gewijzigd.
Saturation	(1~9): Verzadiging van het videobeeld
3DNR	(1~9): Instelling van de ruisonderdrukking. Hoe hoger de waarde, hoe meer ruis softwaretechnisch uit het videobeeld wordt verwijderd.
Mirror	Spiegeling van het videobeeld  Off: Gedeactiveerd HV: Horizontale en verticale beeldspiegeling (standaard) V: Verticale beeldspiegeling H: Horizontale beeldspiegeling
Back	Terug naar vorige menupagina
Exit	Het menu verlaten
Save&Exit	Opslaan en verlaten van het menu

**Functies**

<b>Functie</b>	<b>Beschrijving</b>
Motion Det	Camera-interne bewegingsdetectie (wordt niet gebruikt)  Gebruik a.u.b. de bewegingsdetectiefunctie in de HDCC DVR.
Privacy	Instellingen voor het maskeren van privé-zones. Er kunnen max. 4 privé-zones vrij in grootte en positie worden gedefinieerd.  MODE:           OFF: Privézonefunctie inactief ON: Privézonemaskering actief AREA NO. 0~3: Instelling van het masker DISPLAY:       OFF: Het masker wordt niet weergegeven ON: Het masker wordt weergegeven. X POSITION:     Horizontale startpositie van het masker Y POSITION:     Verticale startpositie van masker WIDTH:         Horizontale grootte van masker HEIGHT:        Verticale grootte van masker  COLOR:         Instelling voor de kleur van alle maskers TRANSPARENCY: OFF: Alle maskers worden niet transparant weergegeven. ON: Alle maskers worden licht transparant weergegeven, d.w.z. het erachter liggende gedeelte van het beeld wordt gedeeltelijk weergegeven.
Back	Terug naar vorige menupagina
Exit	Het menu verlaten
Save&Exit	Opslaan en verlaten van het menu

**Factory Default (Reset)**

<b>Functie</b>	<b>Beschrijving</b>
Factory Default	Resetten van alle camera-instellingen in het hoofdmenu op de fabrieksinstellingen  IRIS+    Bevestig het proces (NVR PTZ-menu) Cancel   Proces onderbreken

**Back**

<b>Functie</b>	<b>Beschrijving</b>
Back	Terug naar vorige menupagina

**Save&Exit**

<b>Functie</b>	<b>Beschrijving</b>
Save&Exit	Opslaan van alle instellingen en verlaten van het OSD-menu

## 7. Onderhoud en reiniging

### 7.1. Onderhoud

Controleer regelmatig de technische veiligheid van het product, bijvoorbeeld beschadiging van de behuizing.

Als aangenomen moet worden dat een veilig gebruik niet meer mogelijk is, moet het product buiten werking gesteld worden en beveiligd worden tegen onbedoeld gebruik.

Er moet worden aangenomen dat een veilig gebruik niet meer mogelijk is, als

- het apparaat zichtbare beschadigingen heeft,
- het apparaat niet meer functioneert



#### Neem het volgende in acht:

Het product is voor u onderhoudsvrij. Er bevinden zich voor u geen te controleren of te onderhouden componenten binnen in het product. Open het product dus nooit.

### 7.2. Reiniging

Reinig het product met een schone, droge doek. Bij sterkere vervuiling kan de doek met een beetje lauw water bevochtigd worden.



Let op dat er geen vocht in het apparaat binnendringt. Gebruik geen chemische reinigingsmiddelen, omdat hierdoor het oppervlak van de behuizing en het beeldscherm beschadigd kunnen raken (verkleuringen).

## 8. Afdanken



Let op: De EU-richtlijn 2002/96/EG regelt de correcte terugname, behandeling en recycling van gebruikte elektronische apparaten. Dit symbool betekent dat in het belang van de milieubescherming het apparaat aan het einde van zijn levensduur conform de geldende wettelijke voorschriften en gescheiden van het huishoudelijk afval of het bedrijfsafval moet worden afgevoerd. Het af te danken apparaat kan via de officiële inzamelpunten in uw land worden afgevoerd. Volg de ter plaatse geldende voorschriften op bij de afvoer van materialen. Gedetailleerde informatie over het terugnemen krijgt u bij de lokale autoriteiten (ook in landen, die niet zijn aangesloten bij de Europese Unie). Door het gescheiden inzamelen en recyclen worden de natuurlijke hulpbronnen ontzien en wordt ervoor gezorgd dat bij de recycling van het product alle bepalingen voor de bescherming van gezondheid en milieu in acht genomen worden.



## HDCC35500



## Betjeningsvejledning

Version 02/2019



*Dansk oversættelse af den originale tyske betjeningsvejledning. Opbevares til fremtidig anvendelse!*

## Indledning

Kære kunde

Tak, fordi du har valgt at købe dette produkt.

Udstyret opfylder kravene i følgende EU-direktiver: EMC-direktiv 2014/30/EU samt RoHS-direktiv 2011/65/EU.

For at kunne bibeholde denne tilstand og sikre en ufarlig drift skal du som bruger følge denne betjeningsvejledning!

Læs hele betjeningsvejledningen igennem før idriftsættelsen af produktet, og overhold alle betjenings- og sikkerhedshenvisninger!

**Alle indeholdte firmanavne og produktbetegnelser er varemærker, der tilhører den pågældende ejer. Alle rettigheder forbeholdes.**

**I tilfælde af spørgsmål bedes du henvende dig til din installatør eller forhandler!**





### Ansvarsfritagelse

Denne betjeningsvejledning er udarbejdet meget omhyggeligt. Hvis du alligevel finder udeladelser eller unøjagtigheder, bedes du meddele os dette på adressen, der er anført på bagsiden af håndbogen. ABUS Security-Center GmbH & Co. KG påtager sig intet ansvar for tekniske og typografiske fejl og forbeholder sig retten til på ethvert tidspunkt uden forudgående varsel at ændre produktet og betjeningsvejledningerne.



ABUS Security-Center er ikke ansvarlig for direkte og indirekte følgeskader, der opstår i forbindelse med dette produkts udstyr, funktion og anvendelse.

Der gælder ingen garanti for indholdet i dette dokument.

## Symbolforklaring

	<b>Symbolet med lynet i trekanten anvendes, når der er fare for helbredet, f.eks. på grund af elektrisk stød.</b>
	<b>Et udråbstegn, der befinder sig i trekanten, gør opmærksom på vigtige henvisninger i betjeningsvejledningen, som ubetinget skal overholdes.</b>
	<b>Dette symbol vises, når du skal have særlige tips og henvisninger vedr. betjeningen.</b>

## Vigtige sikkerhedshenvisninger

	<b>Ved skader, der skyldes manglende overholdelse af denne betjeningsvejledning, bortfalder garantien. Vi påtager os intet ansvar for følgeskader!</b>
	<b>Vi påtager os intet ansvar i forbindelse med materielle skader og/eller personskader, der skyldes ukorrekt håndtering eller manglende overholdelse af sikkerhedshenvisningerne. I sådanne tilfælde bortfalder enhver form for garanti!</b>

**Kære kunde. Følgende sikkerheds- og farehenvisninger anvendes ikke kun til at beskytte dig, men også til at beskytte udstyret. Læs følgende punkter grundigt igennem:**

- Der er ingen dele inde i produktet, der skal vedligeholdes. Derudover bortfalder godkendelsen (CE) og garantien/reklamationsretten, hvis produktet åbnes/skilles ad.
- Produktet kan blive beskadiget, hvis det falder ned fra selv en lav højde.
- Montér produktet, så udstyrets billedoptager ikke udsættes for direkte sollys. Vær opmærksom på monteringshenvisningerne i det pågældende kapitel i denne betjeningsvejledning.
- Udstyret er udviklet til anvendelse indendørs og udendørs (IP67).

Undgå følgende ugunstige omgivelsesbetingelser ved drift:

- Væde eller for høj luftfugtighed
- Ekstrem kulde eller varme
- Direkte sollys
- Støv eller brændbare gasser, dampe eller opløsningsmidler
- Kraftige vibrationer
- Kraftige magnetfelter f.eks. i nærheden af maskiner eller højttalere.
- Kameraet må ikke installeres på ustabile flader.

Generelle sikkerhedshenvisninger:

- Lad ikke emballage ligge og flyde! Plastikfolier/-poser, styropordele osv. kan blive til farligt legetøj for børn.
- Videoovervågningskameraet må af sikkerhedsmæssige årsager ikke komme i hænderne på små børn på grund af smådele, der kan sluges.
- Før ikke genstande gennem åbningerne ind i udstyrets indre
- Anvend kun det ekstraudstyr/de tilbehørsdele, der er anført af producenten. Tilslut ikke produkter, der ikke er kompatible.
- Overhold sikkerhedshenvisninger og betjeningsvejledninger for andet tilsluttet udstyr.
- Kontrollér udstyret for skader før idriftsættelsen. Tag ikke udstyret i drift, hvis det er beskadiget!
- Overhold grænserne for driftsspændingen, der er anført i de tekniske data. Højere spændinger kan ødelægge udstyret og bringe din sikkerhed i fare (elektrisk stød).



### Sikkerhedsanvisninger

1. Strømforsyning: Vær opmærksom på oplysningerne, der står på typeskiltet, hvad angår forsyningsspænding og strømforbrug.
2. Overbelastning  
Undgå at overbelaste stikdåser, forlængerledninger og adaptere, da dette kan medføre brand eller elektrisk stød.
3. Rengøring  
Rengør kun udstyret med en fugtig klud uden stærke rengøringsmidler.  
Udstyret skal i den forbindelse kobles fra nettet.

### Advarsler

Før den første idriftsættelse skal alle sikkerheds- og betjeningshenvisninger læses!

1. Overhold følgende henvisninger for at undgå skader på netkabel og netstik:
  - Træk ikke i netkablet, når udstyret kobles fra nettet, men tag fat i stikket.
  - Sørg for, at netkablet er så langt som muligt fra varmeapparater for at forhindre, at plastbeklædningen smelter.
2. Følg disse anvisninger. Hvis de ikke overholdes, kan det medføre elektrisk stød:
  - Undlad at åbne huset eller strømforsyningen.
  - Stik ikke metalliske eller brandfarlige genstande ind i udstyrets indre.
  - Anvend en overspændingsbeskyttelse for at undgå skader på grund af overspænding (f.eks. tordenvejr).
3. Afbryd defekt udstyr fra strømnettet med det samme, og informér forhandleren.

	Sørg ved installation i et eksisterende videoovervågningsanlæg for, at alt udstyr er koblet fra net- og lavspændingsstrømkredsen.
	Foretag ikke selv montering, installation og kabelføring, hvis du er i tvivl, men overlad det til en fagmand. Ukorrekt og uprofessionelt arbejde på strømnettet eller på husets installationer er ikke kun en fare for dig selv, men også for andre personer. Træk installationernes kabler, så net- og lavspændingskredse altid forløber adskilt og ikke er forbundet med hinanden på noget sted eller kan forbindes på grund af en defekt.

### Udpakning

Håndtér udstyret meget forsigtigt, når du pakker det ud.

	Start med at kontrollere udstyret, hvis den originale emballage er beskadiget. Hvis udstyret er beskadiget, skal du sende det tilbage sammen med emballagen og informere transportfirmaet.
---	--



## Indholdsfortegnelse

<b>1. Korrekt anvendelse .....</b>	<b>60</b>
<b>2. Indhold i kassen.....</b>	<b>60</b>
<b>3. Særlige kendetegn og funktioner.....</b>	<b>60</b>
<b>4. Beskrivelse af kameraet.....</b>	<b>61</b>
<b>5. Montage / installation .....</b>	<b>61</b>
5.1. Montering af kameraet .....	61
5.2. Justering af kameraet.....	62
5.3. Strømforsyning.....	63
5.4. Placering af videokablet.....	63
<b>6. Skærmmenu .....</b>	<b>64</b>
6.1. Åbning af skærmmenuen (OSD).....	64
6.2. Beskrivelse af skærmmenuen (OSD).....	64
<b>7. Vedligeholdelse og rengøring .....</b>	<b>68</b>
7.1. Vedligeholdelse.....	68
7.2. Rengøring .....	68
<b>8. Bortskaffelse .....</b>	<b>68</b>

**1. Korrekt anvendelse**

Kameraet er egnet både til dag- og natfunktion. Det leverer videobilleder i full-HD-opløsning, og udgangssignalet findes i HD-TVI-format. Dermed er det muligt at bruge standardkoaksialkabler til signaloverførslen. Det anvendes til videoovervågning i forbindelse med optagelsesudstyr. Udstyret er udviklet til anvendelse indendørs og udendørs.

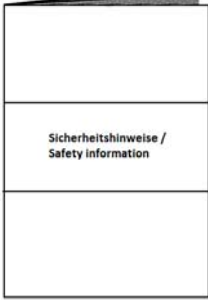
**2. Indhold i kassen**

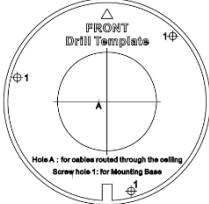
	
<p>Udendørs HD-TVI mini-dome IR</p>	<p>Sikkerhedsanvisninger</p>
	
<p>Installationsværktøj</p>	<p>Boreskabelon</p>

**3. Særlige kendetegn og funktioner**

- 5 megapixel opløsning: 2560 x 1944 @ 20 fps
- Overførsel via almindelig CCTV-infrastruktur (op til 500 meter via et RG59-kabel)
- 2.8 mm fast objektiv
- 4 i 1 videoudgang (omskifteligt TVI / AHD / CVI / CVBS)
- IR-LED'er til natsigt
- 3D DNR til støjfri billeder
- True WDR-funktion til udligning af billedkontraster (120 dB)
- Vejrbeskyttet kamerahus (IP67)
- On-Screen-Menu til kamerakonfiguration (styring med DVR via koaksialkabel)

#### 4. Beskrivelse af kameraet

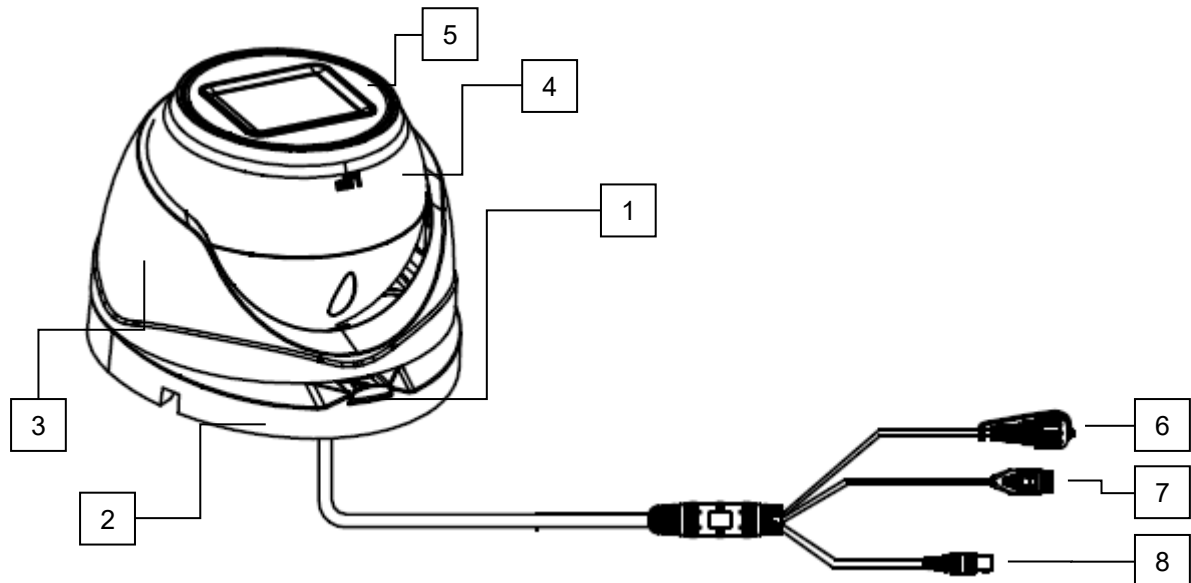

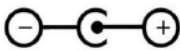
1	Fastgørelseselement med fastgørelsesskrue
2	Kamerabundplade
3	Kamerakappe
4	Kamerahoved
5	IR LED'er
6	Knappen til skifte mellem forskellige videoformater: TVI / AHD / CVI / CVBS Denne funktion er kun tilgængelig i 4M @ 25fps og 4M30fps opløsninger (hold knapperne nede i mere end 3 sekunder)
7	Spændingstilslutning (5,5x2,1 mm, hunstik) 
8	HD-TVI-videoudgang (BNC, påtrykt "TVI")

#### 5. Montage / installation

##### 5.1. Montering af kameraet

	<b>VIGTIGT!</b> Under monteringen skal kameraet være afbrudt fra netspændingen.
---	--

Løsn fastgørelsesskruen på kameraets bundplade, og fjern den. Brug den vedlagte boreskabelon til at bore fastgørelshullerne.

Hvis kablet skal lægges fra siden, skal du først føre tilslutningskablet gennem bundpladen og åbningen på siden af bundpladen.

Fastgør nu bundpladen.

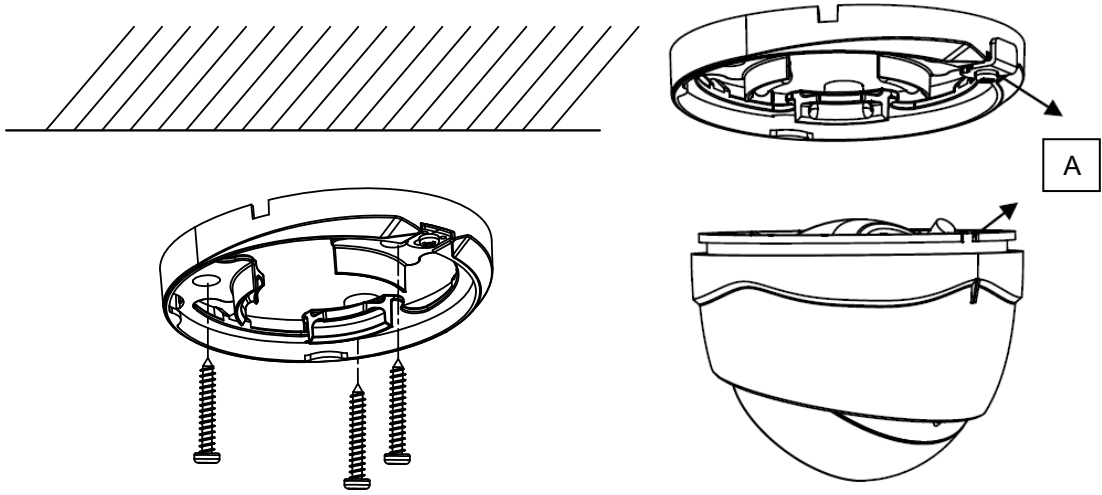

Fastgør derpå kamerahovedet ved at sætte kamerakappen på. Justeringsringen har en udsparring (A) på et sted, hvor fastgørelseselementet kan føres ind i justeringsringen. Stram kun fastgørelsesskruen til kamerakappen let, så du kan foretage den afsluttende justering af kameraet.

5.2. Justering af kameraet



Hvis det er nødvendigt, kan du løsne fastgørelsesskruen på bundpladen. Kameraets midterstykke kan nu justeres i 3 akser. Stram derefter fastgørelsesskruen igen.

<p>The diagram shows the camera body with three axes of adjustment indicated by curved arrows and labels: (A) for tilting (up and down), (B) for panning (horizontal rotation), and (C) for rotation (vertical rotation).</p>	<table border="1"><tr><td>(A) Tiltning</td><td>90°</td></tr><tr><td>(B) Panorering</td><td>360°</td></tr><tr><td>(C) Rotation</td><td>360°</td></tr></table>	(A) Tiltning	90°	(B) Panorering	360°	(C) Rotation	360°
(A) Tiltning	90°						
(B) Panorering	360°						
(C) Rotation	360°						

 Den effektive IR-rækkevidde afhænger af anvendelsesstedet. Lysabsorberende overflader eller ingen IR-lysreflekterende genstande i synsfeltet reducerer IR-rækkevidden eller giver et for mørkt videobillede. Desuden kan reflekterende genstande i umiddelbar afstand af kameraet (tagrende, mur) give forstyrrende refleksioner af IR-lyset i billedet. Vær opmærksom på, at på modeller HDCC35500 dækkes IR-LED'erne ikke af kamerakappen, da der ellers kan opstå refleksioner.

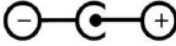

### 5.3. Strømforsyning

	<p><b>VIGTIGT!</b> Før du begynder installationen, skal du sikre, at forsyningsspændingen og kameraets nominelle spænding stemmer overens.</p>
	<p>12 VDC, hunstik, 5,5x2,1mm</p> 

Kameraerne kræver en 12 VDC spændingsforsyning. Jævnspændingens polaritet skal overholdes!

### 5.4. Placering af videokablet

For at overføre kameraets HD-TVI-videosignal til en optager skal der tilsluttes et koaksialkabel af typen RG59 med et BNC-stik (hanstik) til tilslutningen, hvor der er påtrykt "TVI". Kabellængden til det næste udstyr må ikke overstige 500 meter.

	<p>For at sikre at overførslen af HD-TVI-signalet har en optimal kvalitet, må kablet ikke knækkes, klemmes eller lægges i en for lav radius (min. bøjeradius 6 cm). Hvis kablet er beskadiget eller er blevet porøst på grund af alder, kan dette ligeledes påvirke signal- og billedkvalitet (f.eks. skyggedannelse ved kanter).</p>
---	---

## 6. Skærmmenu

### 6.1. Åbning af skærmmenuen (OSD)

Skærmmenuen (OSD, On-Screen-Display) på dette kamera kan kun åbnes via ABUS HD-TVI DVR (med ZOOM/FOCUS). Læs i denne forbindelse betjeningsvejledningen til ABUS HD-TVI DVR.

### 6.2. Beskrivelse af skærmmenuen (OSD)

Hvis du trykker på tasten til OSD-styringen, åbnes OSD-skærmmenuen. Der kan foretages detaljerede indstillinger via denne skærmmenu.

#### HOVEDMENU

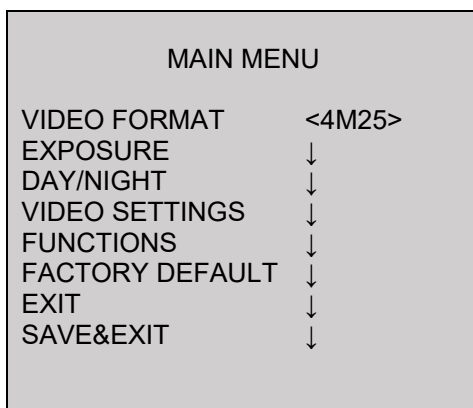

#### Video Format

Funktion	Beskrivelse
Video Format	Indstilling af videoopløsningen  Indstillinger: 5M20: 5 megapixel @ 20 billeder/s 4M25: 4 megapixel @ 25 billeder/s 4M30: 4 megapixel @ 30 billeder/s 2M25: 2 megapixel @ 25 billeder/s 2M30: 2 megapixel @ 30 billeder/s

## Exposure

I dette menupunkt foretages de generelle belyningsindstillinger, f.eks. om kameraet skal bearbejde store kontraster, eller om det har brug for specielle indstillinger til natsigt.

Funktion	Beskrivelse
Exposure Mode	<p>Global: Generel automatisk belyningsindstilling uden WDR-funktion</p> <p>BLC: Automatisk belyningsindstilling med modlyskompensation (Back Light Compensation). BLC-funktionen forbedrer billedvisningen ved mellemstore billedkontraster.</p> <p>WDR: Automatisk belyningsindstilling med WDR-funktion (Wide Dynamic Range). WDR-funktionen bruges til en bedre visning af store billedkontraster. Denne funktion har desuden en 4-trins indstilling til tilpasning efter de aktuelle kontrastforhold.</p>
AGC	<p>Automatisk forstærkerregulering. Jo højere indstilling, jo lysere bliver videobilledet ved dårlige belyningsforhold, men jo mere billedstøj vil der også være.</p> <p>Low: Lav Medium: Mellem High: Høj</p>
Back	Tilbage til forrige menuside
Exit	Menuen forlades
Save&Exit	Henter og forlader menuen

## DAY NIGHT

I dette menupunkt foretages indstillinger for dag-/natskift.

Funktion	Beskrivelse
Auto	<p>Automatisk aktivering/deaktivering af dag- eller nattilstand. Den integrerede lyssensor styrer skiftet afhængigt af belyningsstyrken.</p> <p>IR Light: On: IR LED'er aktiveret i nattilstand Off: IR LED'er deaktiveret i nattilstand</p> <p>Smart IR: Funktion til reduktion af overeksponering af IR-lyset ved nære objekter On: Funktion aktiv Off: Funktion inaktiv</p> <p>D-&gt;N Threshold (1-9): Omstillingstærsklen fra dag- til natmodus N-&gt;D Threshold (1-9): Omstillingstærsklen fra nat- til dagmodus</p> <p>Back: Tilbage til forrige menuside</p>
Color	Kameraet står hele tiden i farvetilstand. Det infrarøde drejefilter er permanent foran objektivet, og IR LED'erne er permanent fra.
B&W	<p>Kameraet står hele tiden i sort/hvid-tilstand. Det infrarøde drejefilter er fjernet permanent fra objektivet. IR LED'erne aktiveres eller deaktiveres automatisk ved hjælp af lyssensoren.</p> <p>IR Light: On: IR LED'er aktiveret i nattilstand Off: IR LED'er deaktiveret i nattilstand</p> <p>Smart IR: Funktion til reduktion af overeksponering af IR-lyset ved nære objekter</p>

	On: Funktion aktiv Off: Funktion inaktiv
--	---

## Video Settings

I dette menupunkt foretages de generelle billedindstillinger som f.eks. kontrast eller spejlvending af videobilledet.

Funktion	Beskrivelse
Image-mode	I dette punkt kan der indstilles 2 forskellige grundindstillinger på kameraet. STD: Standardindstilling HIGH-SAT: Indstilling af et farvemæssigt mere intensivt billede
White Balance	Auto: Automatisk hvidbalance  Manual: Manuel hvidbalance R gain: Forstærkningsfaktoren for de røde toner i billedet B gain: Forstærkningsfaktoren for de blå toner i billedet  Back: Tilbage til forrige menusejde Exit: Menuen forlades Save&Exit: Henter og forlader menuen
Brightness	(1~9): Indstilling af billedets lysstyrke
Contrast	(1~9): Indstilling af billedkontrasten
Sharpness	(1~9): Med denne funktion kan billedets skarphed ændres elektronisk.
Saturation	(1~9): Mætning af videobilledet
3DNR	(1~9): Indstilling af støjundertrykkelsesfunktionen. Jo højere den indstillede værdi er, jo mere støj fjernes der softwareteknisk fra videobilledet.
Mirror	Spejling af videobilledet  Off: Deaktiveret HV: Horisontal og vertikal billedspejling (standard) V: Vertikal billedspejling H: Horisontal billedspejling
Back	Tilbage til forrige menusejde
Exit	Menuen forlades
Save&Exit	Henter og forlader menuen

**Functions**

<b>Funktion</b>	<b>Beskrivelse</b>
Motion Det	Bevægelsesgenkendelse i kameraet (ikke anvendt)  Brug bevægelsesgenkendelsesfunktionen i HDCC DVR.
Privacy	Indstillinger af privatzonemaskering. Der kan frit defineres størrelse og placering af maks. 4 privatzoner.  MODE:           OFF: Privatzonefunktion inaktiv ON: Privatzonemaskering aktiv AREA NO. 0~3: Indstilling af hver enkelt maske DISPLAY:       OFF: Masken vises ikke ON: Masken vises. X POSITION:     Maskens horisontale startposition Y POSITION:     Maskens vertikale startposition WIDTH:         Maskens horisontale størrelse HEIGHT:        Maskens vertikale størrelse  COLOR:         Indstilling af maskernes farve TRANSPARENCY: OFF: Alle masker vises ikke-transparent. ON: Alle masker vises let transparent, dvs. det bagvedliggende billedområde vises delvis.
Back	Tilbage til forrige menuside
Exit	Menuen forlades
Save&Exit	Henter og forlader menuen

**Factory Default (Reset)**

<b>Funktion</b>	<b>Beskrivelse</b>
Factory Default	Nulstilling af alle kameraindstillinger i hovedmenuen til fabriksindstillinger  IRIS+     Bekræft processen (NVR PTZ-menu) Cancel    Afbryd proces

**Back**

<b>Funktion</b>	<b>Beskrivelse</b>
Back	Tilbage til forrige menuside

**Save&Exit**

<b>Funktion</b>	<b>Beskrivelse</b>
Save&Exit	Her gemmes alle indstillinger, og OSD-menuen forlades

## 7. Vedligeholdelse og rengøring

### 7.1. Vedligeholdelse

Kontrollér regelmæssigt produktets tekniske sikkerhed, f.eks. beskadigelse af huset.

Hvis det må antages, at drift ikke længere er mulig uden farer, skal produktet tages ud af drift og sikres mod utilsigtet drift.

Det må antages, at drift ikke længere er mulig uden fare, hvis

- udstyret har synlige skader
- Udstyret ikke længere fungerer

	<p><b>Vær opmærksom på følgende:</b></p> <p>Produktet er vedligeholdelsesfrit for dig. Der er ingen dele inde i produktet, som du skal kontrollere eller vedligeholde: Åbn det aldrig.</p>
---	--

### 7.2. Rengøring

Rengør produktet med en ren, tør klud. Ved kraftigere tilsmudsninger kan kluden fugtes let med lunkent vand.

	<p>Sørg for, at der ikke kommer væsker ind i udstyret.</p> <p>Anvend ikke kemiske rengøringsmidler, da disse kan føre til, at husets overflade og skærmen bliver beskadiget (misfarvninger).</p>
---	--

## 8. Bortskaffelse

	<p>Vigtigt: EU-direktiv 2002/96/EF regulerer den korrekte tilbagetagning, behandling og anvendelse af brugte elektronikapparater. Dette symbol betyder, at med henblik på miljøbeskyttelse skal udstyret efter sin levetid bortskaffes i overensstemmelse med de gældende lovmæssige forskrifter og adskilt fra husholdningsaffald og erhvervsaffald. Bortskaffelsen af det brugte udstyr kan foretages på de respektive officielle indsamlingssteder. Følg de lokale forskrifter, når materialerne bortskaffes. Flere detaljer om tilbagetagelsen (også for lande uden for EU) får du hos dine lokale myndigheder. Ved hjælp af separat indsamling og genanvendelse skånes de naturlige ressourcer, og det sikres, at alle bestemmelser vedrørende beskyttelse af sundhed og miljø overholdes ved genanvendelse af produktet.</p>
---	--

## **HDCC35500**



## **Istruzioni per l'uso**

Versione 02/2019



*Istruzioni per l'uso originali in lingua tedesca. Conservarle per consultazioni future.*

## Introduzione

Gentile cliente,

La ringraziamo per aver acquistato questo prodotto.

Questo dispositivo risponde ai requisiti previsti dalle seguenti direttive europee: direttiva sulla compatibilità elettromagnetica EMC 2014/30/UE e direttiva RoHS 2011/65/UE.

Al fine di preservare tale stato e garantire un funzionamento sicuro, l'utente è tenuto a osservare le presenti istruzioni per l'uso.

Prima di mettere in funzione il prodotto, leggere tutte le istruzioni per l'uso, facendo attenzione alle avvertenze sull'uso e sulla sicurezza.

**Tutti i nomi di aziende e prodotti ivi riportati sono marchi depositati dei rispettivi proprietari. Tutti i diritti riservati.**

**In caso di dubbi rivolgersi al proprio installatore o rivenditore partner specializzato.**



### **Esclusione di responsabilità**

Le presenti istruzioni per l'uso sono state redatte con la massima cura. Se dovesse tuttavia riscontrare omissioni o imprecisioni, La preghiamo di comunicarcele per iscritto all'indirizzo riportato sul retro del manuale.



ABUS Security-Center GmbH & Co. KG non si assume alcuna responsabilità per errori tecnici e tipografici si riserva il diritto di apportare in qualsiasi momento modifiche al prodotto e alle istruzioni per l'uso senza previa comunicazione.

ABUS Security-Center non è perseguibile né responsabile per danni diretti e indiretti subiti in relazione all'equipaggiamento, al rendimento e all'impiego del presente prodotto.



Non si fornisce alcuna garanzia per il contenuto del presente documento.



## Spiegazione dei simboli

	Il simbolo con un fulmine all'interno di un triangolo viene utilizzato quando sussistono pericoli per la salute, ad es. in seguito a scosse elettriche.
	Il punto esclamativo all'interno di un triangolo rimanda ad avvertenze importanti contenute nelle presenti istruzioni per l'uso, che è assolutamente necessario osservare.
	Questo simbolo indica consigli particolari e avvertenze sull'uso del dispositivo.

## Avvertenze importanti sulla sicurezza

	In caso di danni derivanti dal mancato rispetto delle presenti istruzioni per l'uso, il diritto alla garanzia decade. È esclusa la responsabilità per danni indiretti.
	È esclusa la responsabilità per danni a cose o a persone dovuti a un uso improprio o alla mancata osservanza delle avvertenze sulla sicurezza. In tali casi il diritto alla garanzia decade.

**Gentile cliente, le seguenti avvertenze sulla sicurezza e sui pericoli non servono solamente per proteggere la Sua salute ma anche per proteggere il dispositivo. La invitiamo a leggere attentamente i seguenti punti:**

- All'interno del prodotto non ci sono parti che devono essere sottoposte a manutenzione. Inoltre, se il dispositivo viene smontato, l'omologazione (CE) e la garanzia decadono.
- Il prodotto può danneggiarsi anche cadendo da altezze ridotte.
- Montare il prodotto in modo che i raggi del sole non colpiscano direttamente il sensore di immagine dell'apparecchio. Osservare le avvertenze per il montaggio riportate nel relativo capitolo delle presenti istruzioni per l'uso.
- L'apparecchio è concepito per l'utilizzo in ambienti interni ed esterni (IP67).

Durante l'utilizzo evitare le seguenti condizioni ambientali sfavorevoli:

- presenza di acqua o umidità dell'aria troppo elevata
- eccessivo freddo o caldo
- esposizione diretta ai raggi solari
- polvere o gas infiammabili, vapori o solventi
- forti vibrazioni
- potenti campi magnetici, come in prossimità di macchine o altoparlanti.
- la telecamera non deve essere installata su superfici instabili.

Avvertenze di sicurezza generali:

- Non lasciare il materiale di confezionamento in giro con noncuranza. Fogli/sacchetti di plastica, parti in polistirolo ecc. possono rivelarsi giochi pericolosi per i bambini.
- A causa delle piccole parti ingeribili, per motivi di sicurezza la telecamera per videosorveglianza non deve finire nelle mani dei bambini.
- Non introdurre alcun oggetto all'interno dell'apparecchio attraverso le aperture
- Utilizzare esclusivamente apparecchi supplementari/accessori indicati dal produttore. Non collegare prodotti incompatibili.
- Osservare le avvertenze di sicurezza e le istruzioni per l'uso degli altri dispositivi collegati.
- Prima di mettere in funzione il dispositivo controllare se sono presenti danni; in tal caso non azionare il dispositivo.
- Rispettare i limiti della tensione di esercizio indicati nei dati tecnici. Tensioni maggiori possono distruggere il dispositivo e compromettere la sicurezza dell'utente (scossa elettrica).



**Avvertenze di sicurezza**

1. Alimentazione elettrica: Per l'alimentazione di tensione e il consumo di corrente prestare attenzione ai dati indicati sulla targhetta.
2. Sovraccarico  
Evitare di sovraccaricare prese di corrente, cavi di prolunga e adattatori, in quanto potrebbero verificarsi incendi o scosse elettriche.
3. Pulizia  
Pulire l'apparecchio solo con un panno umido, senza utilizzare detergenti aggressivi.  
Scollegare l'apparecchio dalla rete elettrica.

**Avvertenze**

Prima della messa in funzione iniziale devono essere osservate tutte le avvertenze sulla sicurezza e sull'utilizzo.

1. Per evitare danni al cavo di rete e alla spina di alimentazione, osservare le seguenti avvertenze:
  - Quando si scollega l'apparecchio dalla rete elettrica non tirare il cavo di rete bensì afferrare la spina.
  - Assicurarci che il cavo di rete si trovi il più lontano possibile da fonti di calore per evitare si fonda il rivestimento in plastica.
2. Rispettare le seguenti istruzioni. La mancata osservanza può provocare una scossa elettrica:
  - Non aprire mai l'alloggiamento o l'alimentatore.
  - Non infilare oggetti metallici o infiammabili all'interno dell'apparecchio.
  - Per evitare danni dovuti a sovratensioni (ad esempio in caso di temporali), utilizzare una protezione contro le sovratensioni.
3. Scollegare immediatamente gli apparecchi difettosi dalla rete elettrica e informare il proprio rivenditore specializzato.

	In caso di installazione all'interno di un impianto di videosorveglianza preesistente, assicurarsi che tutti gli apparecchi siano separati dal circuito di alimentazione e di bassa tensione.
	In caso di dubbi non eseguire autonomamente il montaggio, l'installazione e il cablaggio, ma affidarsi a un tecnico specializzato. Interventi sulla rete elettrica o sugli impianti domestici svolti in maniera non appropriata o non professionale rappresentano un pericolo non solo per se stessi ma anche per gli altri. Cablare gli impianti in modo tale che i circuiti elettrici e di bassa tensione rimangano sempre separati, non siano collegati fra loro in nessun punto e non possano nemmeno essere collegati accidentalmente.

**Disimballaggio**

Maneggiare l'apparecchio con la massima attenzione mentre lo si disimballa.

	Se l'imballaggio originale dovesse presentare danni, controllare subito l'apparecchio. Se l'apparecchio risulta danneggiato, rispedirlo con l'imballaggio e informare il servizio consegne.
---	---



**Indice**

<b>1. Conformità d'uso .....</b>	<b>73</b>
<b>2. Dotazione.....</b>	<b>73</b>
<b>3. Caratteristiche e funzioni.....</b>	<b>73</b>
<b>4. Descrizione della telecamera.....</b>	<b>74</b>
<b>5. Montaggio / Installazione .....</b>	<b>74</b>
5.1. Montaggio della telecamera .....	74
5.2. Allineamento della telecamera .....	75
5.3. Alimentazione elettrica .....	76
5.4. Installazione del cavo video .....	76
<b>6. Menu su schermo .....</b>	<b>77</b>
6.1. Apertura del menu su schermo (OSD).....	77
6.2. Descrizione del menu su schermo (OSD).....	77
<b>7. Manutenzione e pulizia.....</b>	<b>81</b>
7.1. Manutenzione.....	81
7.2. Pulizia.....	81
<b>8. Smaltimento .....</b>	<b>81</b>

**1. Conformità d'uso**

La telecamera dome è adatta per la sorveglianza sia diurna che notturna. Fornisce immagini video in risoluzione Full-HD e il segnale in uscita è disponibile in formato HD-TVI. Questo permette l'utilizzo di un tradizionale cavo coassiale per la trasmissione del segnale, che serve per la video sorveglianza unitamente a un registratore. L'apparecchio è concepito per l'utilizzo in ambienti interni ed esterni.

**2. Dotazione**

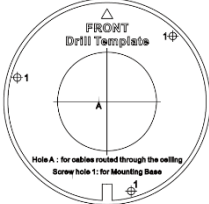
	
<p>Telecamera Mini Dome HD-TVI per esterni IR</p>	<p>Avvertenze di sicurezza</p>
	
<p>Strumenti per l'installazione</p>	<p>Dima di foratura</p>

**3. Caratteristiche e funzioni**

- Risoluzione 5 megapixel: 2560 x 1944 @ 20 fps
- Trasmissione tramite normale infrastruttura TVCC (fino a 500 metri con cavo RG59)
- Obiettivo fisso da 2.8 mm
- Uscita video 4 in 1 (commutabile TVI / AHD / CVI / CVBS)
- LED IR per visione notturna
- Funzione 3D DNR per immagini senza rumore
- Funzione True WDR per il bilanciamento di contrasti nell'immagine (120 dB)
- Custodia protettiva contro gli agenti atmosferici (IP67)
- Menu on-screen per la configurazione della telecamera (comando tramite DVR e cavo coassiale)

**4. Descrizione della telecamera**

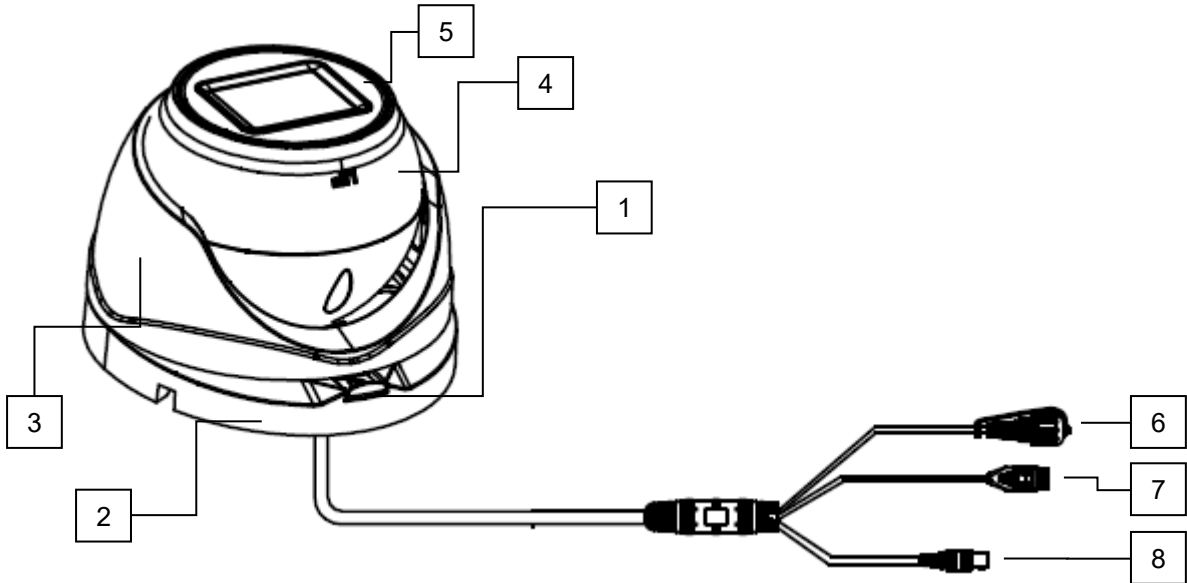

1	Elemento con vite di fissaggio
2	Piastra di base della telecamera
3	Cappuccio della telecamera
4	Testa della telecamera
5	LED IR
6	Pulsante per passare tra diversi formati video: TVI / AHD / CVI / CVBS Questa funzione è disponibile solo nelle risoluzioni 4M @ 25fps e 4M30fps (tenere premuti i pulsanti per più di 3 secondi)
7	Collegamento elettrico (5,5x2,1mm, spina coassiale) 
8	Uscita video (BNC, dicitura "TVI")

**5. Montaggio / Installazione**

**5.1. Montaggio della telecamera**

	<p><b>ATTENZIONE!</b> Durante il montaggio la telecamera deve essere scollegata dalla rete elettrica.</p>
--	---

Svitare e rimuovere la vite di fissaggio sulla piastra di base della telecamera e rimuoverla. Utilizzare la dima di foratura in dotazione per l'esecuzione dei fori di fissaggio.

Se la posa dei cavi deve essere eseguita lateralmente, allora far passare prima il cavo di allacciamento attraverso la piastra di base e l'apertura laterale della piastra.

A questo punto fissare la piastra di base.

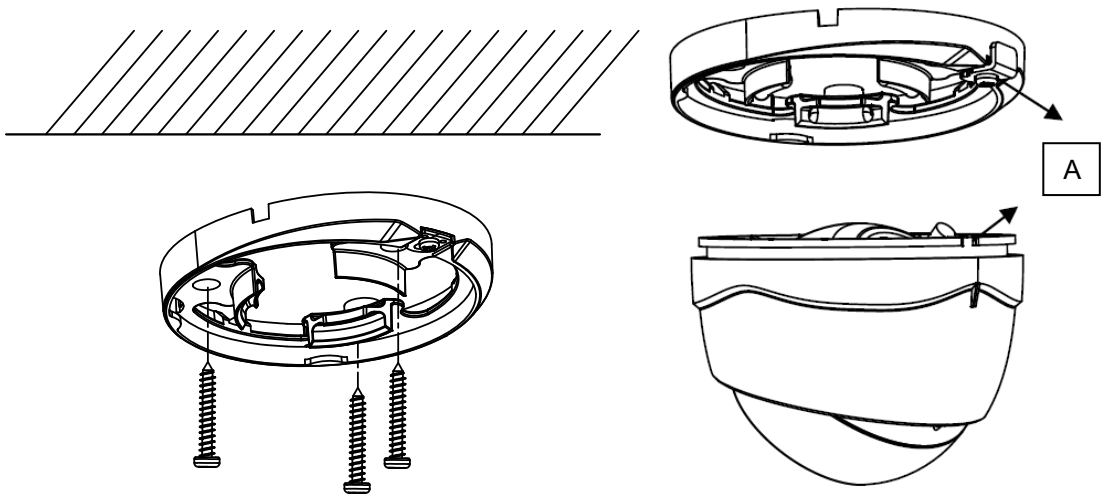

Fissare quindi la testa della telecamera posizionando il cappuccio. L'anello di aggiustamento presenta un invaco (A) nel quale può essere inserito l'elemento di fissaggio nell'anello di aggiustamento. Avvitare solo leggermente la vite di fissaggio del cappuccio della telecamera per regolare l'allineamento della telecamera.



**5.2. Allineamento della telecamera**

Se necessario, allentare la vite di fissaggio sulla piastra di base della telecamera. La parte centrale della telecamera può ora essere orientata secondo tre assi. Serrare quindi saldamente la vite di fissaggio nella sua sede.

	<table border="0"><tr><td>(A) Regolazione verticale</td><td>90°</td></tr><tr><td>(B) Regolazione orizzontale</td><td>360°</td></tr><tr><td>(C) Rotazione</td><td>360°</td></tr></table>	(A) Regolazione verticale	90°	(B) Regolazione orizzontale	360°	(C) Rotazione	360°
(A) Regolazione verticale	90°						
(B) Regolazione orizzontale	360°						
(C) Rotazione	360°						

 La portata IR effettiva dipende dal luogo d'uso. Superfici che assorbono la luce o oggetti che non rifrangono la luce IR nel campo visivo riducono la portata IR, ovvero generano un'immagine video troppo scura. Oggetti rifrangenti nelle immediate vicinanze della telecamera (grondaia, parete) possono inoltre causare nell'immagine riflessi di disturbo della luce IR. Si fa notare che nei modelli HDCC35500 i LED IR non sono coperti dal cappuccio della telecamera, altrimenti si potrebbero avere riflessi.

### 5.3. Alimentazione elettrica

	<p><b>ATTENZIONE!</b> Prima di procedere all'installazione, assicurarsi che la tensione di alimentazione e la tensione nominale della telecamera coincidano.</p>
	<p>12 V CC, spina coassiale, 5,5 x 2,1 mm</p> 

Le telecamere richiedono una alimentazione di tensione di 12 V CC. Assicurarsi che la polarità dell'alimentazione di tensione continua sia corretta.

### 5.4. Installazione del cavo video

Per trasmettere il segnale video HD-TVI della telecamera a un registratore, collegare all'attacco con la dicitura "TVI" un cavo coassiale di tipo RG59 con connettore BNC (maschio). La lunghezza del cavo fino all'apparecchio successivo non deve essere superiore a 500 m.

	<p>Per garantire una qualità ottimale della trasmissione del segnale HD-TVI, è necessario che il cavo non sia piegato né schiacciato in alcun punto, né posato in un raggio troppo piccolo (raggio di curvatura min. 6 cm). Se il cavo è danneggiato o si è usurato con il passare del tempo, il segnale o la qualità delle immagini possono risentirne (ad es. possono apparire ombre vicino ai bordi).</p>
---	--

## 6. Menu su schermo

### 6.1. Apertura del menu su schermo (OSD)

Il menu su schermo (OSD, On-Screen-Display) di questa telecamera può essere aperto soltanto con DVR HD-TVI ABUS (con ZOOM/FOCUS). Consultare quindi le istruzioni per l'uso del DVR HD-TVI ABUS.

### 6.2. Descrizione del menu su schermo (OSD)

Premendo il pulsante per la gestione del menu OSD si apre il menu su schermo OSD. Da questo menu su schermo possono essere operate modifiche dettagliate alle impostazioni.

#### MENU PRINCIPALE

MAIN MENU	
VIDEO FORMAT	<4M25>
EXPOSURE	↓
DAY/NIGHT	↓
VIDEO SETTINGS	↓
FUNCTIONS	↓
FACTORY DEFAULT	↓
EXIT	↓
SAVE&EXIT	↓

#### Video Format

Funzione	Descrizione
Video Format	<p>Impostazione per la risoluzione video</p> <p>Opzioni:</p> <p>5M20: 5 Megapixel a 20 immagini/s</p> <p>4M25: 4 Megapixel a 25 immagini/s (standard)</p> <p>4M30: 4 Megapixel a 30 immagini/s</p> <p>2M25: 2 Megapixel a 25 immagini/s</p> <p>2M30: 2 Megapixel a 30 immagini/s</p>



## Exposure

Da questa voce di menu vengono modificate le impostazioni generali di illuminazione, ad es. se la telecamera deve elaborare i contrasti elevati, o se la telecamera necessita di impostazioni particolari per la visione notturna.

Funzione	Descrizione
Exposure Mode	<p>Global: impostazione generale e automatica dell'esposizione senza funzione WDR</p> <p>BLC: impostazione automatica dell'esposizione con compensazione del controluce (back light compensation). La funzione BLC migliora l'immagine con contrasti medi.</p> <p>WDR: impostazione automatica dell'esposizione con funzione WDR (wide dynamic range). La funzione WDR serve per migliorare la visualizzazione di contrasti alti. Questa funzione dispone di una funzione a 4 livelli per la regolazione del contrasto dell'immagine.</p>
AGC	<p>Regolazione automatica dei rinforzi. Quanto più alta è l'impostazione, tanto più chiara è l'immagine video in condizioni di luce sfavorevoli, tanto più alto è aumenta il rumore dell'immagine.</p> <p>Low: basso Medium: Medio High: Alto</p>
Back	Ritorno alla pagina precedente del menu
Exit	Uscita dal menu
Save&Exit	Salvataggio e uscita dal menu

## DAY NIGHT

Da questa voce del menu viene impostata la modalità per la commutazione giorno/notte.

Funzione	Descrizione
Auto	<p>Attivazione/disattivazione automatica della modalità giorno/notte. Il sensore luce integrato gestisce la commutazione a seconda dell'intensità luminosa.</p> <p>IR Light: On: LED IR attivi nella modalità notte Off: LED IR non attivi nella modalità notte</p> <p>Prevenzione sovraesposizione: Funzione per la riduzione dell'irraggiamento della luce a IR per gli oggetti vicini On: Funzione attiva Off: funzione disattivata</p> <p>D-&gt;N Threshold (1-9): soglia di commutazione dalla modalità giorno alla modalità notte</p> <p>N-&gt;D Threshold (1-9): soglia di commutazione dalla modalità notte alla modalità giorno</p> <p>Back: Ritorno alla pagina precedente del menu</p>
Color	La telecamera rimane sempre nella modalità a colori. Il filtro orientabile a infrarossi rimane sempre davanti all'obiettivo e i LED IR sono sempre spenti.
B&W	La telecamera rimane sempre nella modalità bianco/nero. Il filtro orientabile a infrarossi è sempre rimosso dall'obiettivo. I LED IR

	<p>vengono automaticamente regolati e quindi attivati o disattivati tramite il fotosensore.</p> <p>IR Light:                    On: LED IR attivi nella modalità notte    Off: LED IR non attivi nella modalità notte</p> <p>Prevenzione sovraesposizione: Funzione per la riduzione dell'irraggiamento della luce a IR per gli oggetti vicini On: Funzione attiva Off: funzione disattivata</p>
--	--

**Video Settings**

Da questa voce di menu si modificano le impostazioni generali dell'immagine, come ad es. il contrasto o la riflessione dell'immagine video.

<b>Funzione</b>	<b>Descrizione</b>
Image Mode	In questa modalità sono disponibili due diverse impostazioni di base per la telecamera. STD:                    impostazione standard HIGH-SAT:            impostazione per immagini dai colori più vivaci
White Balance	Auto:                    Bilanciamento automatico del bianco  Manual:                bilanciamento manuale del bianco R Gain: fattore di rinforzo per la percentuale di rosso nell'immagine B Gain: fattore di rinforzo per la percentuale di blu nell'immagine  Back:                    Ritorno alla pagina precedente del menu Exit:                    Uscita dal menu Save&Exit:            Salvataggio e uscita dal menu
Brightness	(1~9):                    impostazione della luminosità delle immagini
Contrast	(1~9):                    impostazione del contrasto delle immagini
Sharpness	(1~9):                    Con questa funzione può essere modificata elettronicamente la percezione della nitidezza dell'immagine.
Saturation	(1~9):                    Saturazione dell'immagine video
3DNR	(1~9):                    Impostazione della funzione di soppressione digitale dei rumori. Quanto maggiore è il valore impostato, tanto più rumori vengono eliminati tramite software.
Mirror	Riflessione dell'immagine video  Off:                    disattivata HV:                    riflessione orizzontale e verticale dell'immagine (standard) V:                    Riflessione verticale dell'immagine H:                    Riflessione orizzontale dell'immagine
Back	Ritorno alla pagina precedente del menu
Exit	Uscita dal menu
Save&Exit	Salvataggio e uscita dal menu

## Functions

Funzione	Descrizione
Motion Det	Riconoscimento del movimento interno alla videocamera (non utilizzato)  Utilizzare la funzione di riconoscimento del movimento in HDCC DVR.
Privacy	impostazioni per la mascheratura delle zone private. Possono essere definite fino a 4 zone private, senza vincoli di grandezza o posizione.  MODE:           OFF: Funzione zone private non attiva ON: mascheratura zone private attiva AREA NO. 0~3: Impostazione della maschera relativa DISPLAY:       OFF: La maschera non viene mostrata ON: La maschera viene mostrata. X POSITION:     Posizione iniziale orizzontale della maschera Y POSITION:     Posizione iniziale verticale della maschera WIDTH:         Grandezza orizzontale della maschera HEIGHT:        Grandezza verticale della maschera  COLOR:         Impostazione del colore per tutte le maschere TRANSPARENCY: OFF: Le maschere non sono trasparenti. ON: Tutte le maschere sono leggermente trasparenti, ossia l'area dell'immagine sottostante è parzialmente visibile.
Back	Ritorno alla pagina precedente del menu
Exit	Uscita dal menu
Save&Exit	Salvataggio e uscita dal menu

## Factory Default (Reset)

Funzione	Descrizione
Factory Default	Ripristino delle impostazioni di fabbrica di tutte le impostazioni della telecamera nel menu principale  IRIS+     confermare la procedura (menu NVR PTZ) Cancel    annullare la procedura

## Back

Funzione	Descrizione
Back	Ritorno alla pagina precedente del menu

## Save&Exit

Funzione	Descrizione
Save&Exit	Salvataggio di tutte le impostazioni e uscita dal menu OSD

## 7. Manutenzione e pulizia

### 7.1. Manutenzione

Verificare regolarmente la sicurezza tecnica del prodotto, ad esempio la presenza di danni all'alloggiamento.

Se si presume che il funzionamento non sia più sicuro, il prodotto deve essere messo fuori servizio, assicurandosi che non sia accidentalmente rimesso in funzione.

Si deve presumere che non sia più possibile un utilizzo sicuro quando il dispositivo

- l'apparecchio presenta danni evidenti,
- non funziona più



#### Fare attenzione a quanto segue:

Il prodotto non richiede manutenzione da parte dell'utente. All'interno del prodotto non sono presenti componenti controllabili o riparabili dall'utente; pertanto non aprirlo mai.

### 7.2. Pulizia

Pulire il prodotto con un panno asciutto e pulito. Per rimuovere la sporcizia più ostinata, il panno può essere leggermente inumidito con acqua tiepida.



Fare attenzione a non far penetrare liquidi all'interno del dispositivo.

Non utilizzare detergenti chimici, in quanto la superficie dell'alloggiamento e dello schermo potrebbe venire danneggiata (scolorimento).

## 8. Smaltimento



Attenzione: La direttiva europea 2002/96/CE disciplina la corretta raccolta, il trattamento e il riciclaggio di apparecchiature elettroniche usate. Questo simbolo significa che, ai fini della tutela ambientale, il dispositivo deve essere smaltito al termine della sua vita utile conformemente alle prescrizioni di legge in vigore e separatamente dai rifiuti domestici e aziendali. Lo smaltimento del vecchio apparecchio può avvenire nei relativi centri di raccolta ufficiali del proprio Paese. Attenersi alle disposizioni vigenti sul posto per lo smaltimento dei materiali. Per ulteriori informazioni sulla raccolta (anche per i Paesi extracomunitari), rivolgersi alle proprie autorità amministrative. La raccolta separata e il riciclaggio aiutano a preservare le risorse naturali, garantendo l'osservanza di tutte le disposizioni sulla tutela della salute e dell'ambiente in fase di riciclaggio del prodotto.