



Security Tech Germany

# SHHA10000

## ABUS Z-Wave Wireless Socket



Important information and FAQs about this product and other products can be found on the website

[www.abus.com](http://www.abus.com)

Version 1.3

*Original operating instructions in English.  
Keep for future use!*



## Introduction

Dear customer,

We are pleased that you have chosen our product and thank you for your trust! You made a good choice.

This Wireless Socket (hereinafter referred to as the "device") has been developed and manufactured with the utmost care. Please read these operating instructions completely and observe all operating and safety instructions, as this ensures the best possible handling of the device. This document is an installation and maintenance manual.

**If you have any questions, please contact your specialist trade partner  
or contact our customer service:**

**Mail: ABUS Support, Linker Kreuthweg 5, 86444 Affing, Germany**

**E-mail: [support@abus-sc.com](mailto:support@abus-sc.com)**

**Phone: +49 8207 959 90 888**

**Hotline opening hours: Mon-Thu: 08 - 17 h; Fri: 08 - 14 h**

**ABUS Security-Center hereby declares that the enclosed product comply with the requirements of the following directives**

RED Directive (2014/53/EU), EMC Directive (2014/30/EU), Low Voltage Directive (2014/35/EU) and RoHS Directive (2011/65/EU). The full EU Declaration of Conformity text can be found at:

[www.abus.com/product/SHBW10000](http://www.abus.com/product/SHBW10000)

It can also be obtained at the following adress:

**ABUS Security-Center GmbH & Co. KG,  
Linker Kreuthweg 5, 86444 Affing, GERMANY**

All contained company names and product designations are trademarks of the respective owners. All rights reserved.



### Disclaimer of Liability

These operating instructions have been prepared with the greatest care. Should you nevertheless notice omissions or inaccuracies, please inform us in writing at the above address.

Your rights are limited to the repair or replacement of this product as delivered. ABUS Security Center assumes no liability for any special, incidental or consequential damages, including but not limited to loss of revenue, loss of profit, restrictions in the use of the software, loss or recovery of data, costs for replacement equipment, downtime, property damage and claims of third parties, as a result of and in connection with the use of the software. a. warranty, contractual, legal or claims for damages notwithstanding other limited or implied warranty provisions or in the event that the limited warranty does not apply, the scope of liability of ABUS Security Center is limited to the purchase price of the product.

The contents of this manual are subject to change without notice.

© ABUS Security-Center GmbH & Co. KG, 09/2018

## Important Safety Informations

### Intended Use

Only use the device for the purpose for which it was built and designed. Any other use is considered unintended.

**All guarantee claims are invalid in the event of damage caused by non-compliance with this safety information. We cannot be held liable for resulting damage.**

### Unboxing

Handle the device with extreme care when unpacking it.

Packaging and packaging aids can be reused and, as far as possible, should be sent for recycling.

**If the original packaging has been damaged, inspect the device first. If the device shows signs of damage, return it in the original packaging and inform the delivery service.**

### Installation location / operating environment

Do not place any heavy objects on the device. The device is only designed for operation in spaces with appropriate temperatures or humidity (e.g. not for bathrooms). Do also not place the device in areas with excessive accumulation of dust. Please refer to the individual devices' technical data for more detailed information. Ensure that: adequate ventilation is always guaranteed; no direct sources of heat can affect the device; interior devices are not exposed to direct sunlight or strong artificial light; the device is not in the immediate vicinity of magnetic fields (e.g. loudspeakers); no naked flames (e.g. lit candles) are placed on or next to the device; sprayed or dripping water is prevented from coming into contact with interior devices and caustic fluids are avoided; the device is not operated in the vicinity of water, in particular, the device should never be submerged (do not place objects containing fluids, e.g. vases or drinks, on or near the device); no foreign bodies penetrate the device; the device is not exposed to wide temperature variations, as otherwise there may be condensation from humidity causing electrical short circuits; the device is not exposed to excessive shock or vibration.

### Children

Keep electrical devices out of reach of children. Never allow children to use electrical devices unsupervised. Children may not always properly identify possible hazards. Small parts may be fatal if swallowed. Keep packaging film away from children. There is a risk of suffocation. This device is not intended for children. If used incorrectly, parts under spring tension may fly out and cause injury to children (e.g. to eyes).

### Information on handling batteries

- Make sure that batteries are kept away from small children. Children may put batteries in their mouths and swallow them. This can cause serious harm to their health. If this happens, consult a doctor immediately.
- Do not charge normal batteries, heat them up or throw them into naked flames (they may explode).
- The battery must not be directly exposed to heat or sunlight, and must not be stored in a place with a very high temperature.
- The battery must not come into contact with water.
- The battery must not be dismantled, pierced or otherwise damaged.
- The battery contacts must not be short-circuited.
- Change low batteries in good time.
- Always change all the batteries at the same time and use batteries of the same type.
- Leaky or damaged batteries can cause chemical burns on contact with the skin. In this case, wear protective gloves. Clean the battery compartment with a dry cloth.

### Important information on battery disposal



Batteries with this label do not contain harmful substances such as cadmium, lead and mercury. However, used batteries must not be disposed of along with household waste in accordance with the battery directive. To protect natural resources and promote the recycling of materials, separate the batteries from other waste and deposit them at a local recycling center. An additional label with the chemical symbols for Hg, Cd or Pb means that the batteries contain quantities of mercury, cadmium or lead which exceed the restrictions set by the EU Directive 2006/66/EG. If batteries are not disposed of properly, these substances can cause harm to human health or the environment

### Cleaning

- Dusty devices must be cleaned. You can clean dust from the air vents using a vacuum cleaner or compressed air. If necessary, you can remove the dust with a brush.
- You can clean the surface using a cloth slightly dampened in soapy water. Only use suitable microfiber cloths for high-gloss surfaces.
- Do not allow water to penetrate the device.
- Do not clean the device in a dishwasher.
- Do not use sharp, pointed, abrasive or corrosive cleaning materials or hard brushes.
- Do not use chemicals.
- Do not use flammable liquids for cleaning the device.

### Information on device disposal



Important: The EU Directive 2012/19/EU regulates the proper return, treatment and recycling of used electronic devices. This symbol means that in the interest of environmental protection the device must be disposed of separately from household or industrial waste at the end of its service life in accordance with applicable local legal guidelines. Disposing of used devices can be done at official recycling centers in your country. Obey local regulations when disposing of material. Further details on returns (also for non-European countries) can be obtained at your local authority. Separate collection and recycling saves natural resources and ensures that all the provisions for protecting health and environment are observed when recycling the product.

## Table of Contents

1. Product introduction .....	6
1.1. Scope of Delivery.....	6
1.2. Device features.....	6
1.3. Operating principle .....	6
1.4. Performance Features .....	7
1.5. Use in systems of different manufacturers .....	7
2. Overview of functions .....	8
2.1. Inclusion / Add Device .....	8
2.2. Operating .....	9
2.3. Exclusion / Remove Device .....	9
2.4. Reset (Factory-Reset) .....	10
3. Advanced Z-Wave Parameter .....	10
3.1. Association Group Information .....	10
3.2. Overview Configuration Parameter .....	11
3.3. Command Classes .....	13
4. Technical Specifications .....	14

## 1. Product introduction

### 1.1. Scope of Delivery

- ABUS Z-Wave Radio-Plug
- Quickguide & Safety instructions

### 1.2. Device features

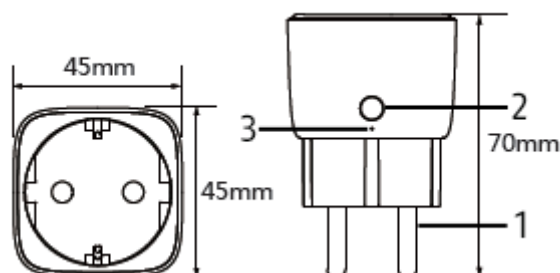

Nr	Label	Comment
1	Power plug	
2	Network-Button	For inclusion / exclusion of the detector in a Z-Wave gateway, factory reset and tamper alarm
3	Status-LED	

### 1.3. Operating principle

The SHHA10000 was developed for use in home automation systems that use the Z-Wave wireless standard. The power outlet enables you to switch a large number of your electronic devices - conveniently and directly via the gateway's app or automatically according to an individual schedule.

In conjunction with configurable scenes, a large number of smart functions can be initiated, e.g. a presence simulation or you can preheat the coffee machine before getting up.

#### **1.4. Performance Features**

The ABUS Z-Wave SHHA10000...:

- ...is a wireless socket
- ...is Z-Wave PLUS compatible & certified
- ...supports the Z-Wave S2 Standard (Security 2)
- ... measures your (current) consumption values reliably over any period of time
- ...detects applied mains voltage, wattage consumption, kWh and ampere
- ... can be switched on and off via app or manually
- ... was developed for indoor installation

#### **1.5. Use in systems of different manufacturers**

Communication is via the Z-Wave EU frequency (868.42 Mhz). You can integrate the device into any Z-Wave network with a certified Z-Wave gateway, regardless of manufacturer. All non-battery powered nodes in the network act as repeater to increase the durability of the network.

## 2. Overview of functions

### 2.1. Inclusion / Add Device

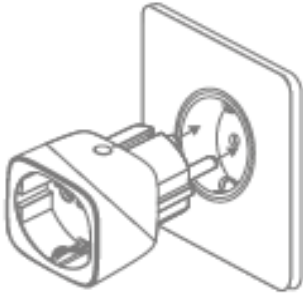

Plug the Wireless-Socket into an outlet. The Status-LED is flashing.

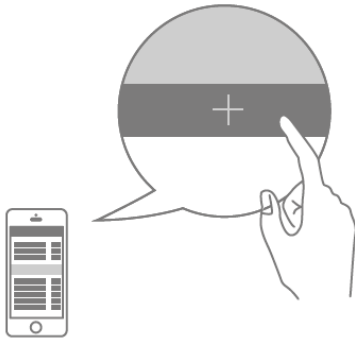

Click the + (Add) button in your Z-Wave App and follow the further instructions

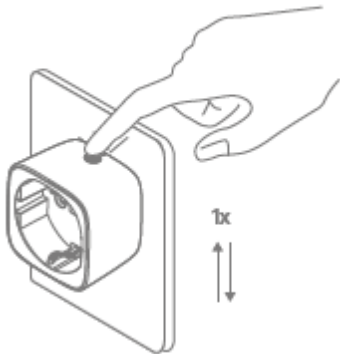

Press the Network-Button on the Socket once

The App will show if the Add device process was successful

The Status LED does not flash anymore but indicates if device is switched on or off

Repeat the inclusion process if it was not successful.



## 2.2. Operating

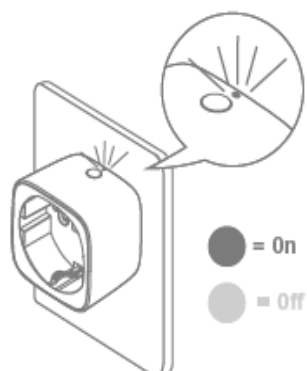

Switch the Wireless Socket either via the integrated button or once connected to a Z-Wave Gateway via App

Status-LED is on = Wireless Socket is switched on  
 Status-LED is off = Wireless Socket is switched off

Never connect wireless Sockets in series!

The Wireless-Socket must be easily accessible.

## 2.3. Exclusion / Remove Device

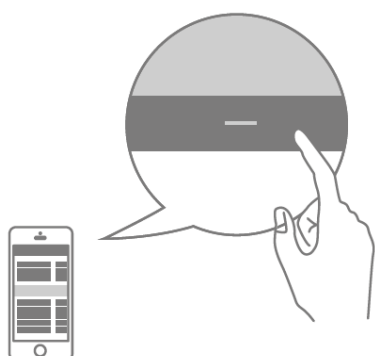

Click the - (Remove) button in your Z-Wave App and follow the further instructions

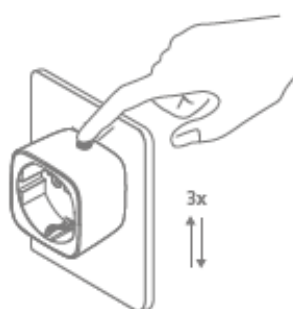

Press the Button on the socket 3 times

The App will show if the Remove Device process was successful.

The Status-LED will now flash continuously

Repeat the exclusion process if it was not successful.

## 2.4. Reset (Factory-Reset)

Keep pressing the Button on the socket for more than 5 seconds (the flash interval of the Status LED is now accelerated)

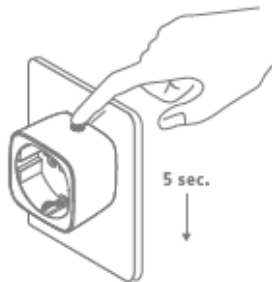

The wireless socket is now restored to factory settings

**Note:**

This procedure should only be used if the primary gateway is not capable of acting.

If the device is set to the factory setting, the status is set to "not included", the association settings and possible configurations are reset to default.

## 3. Advanced Z-Wave Parameter

### 3.1. Association Group Information

Z-Wave devices can control other devices directly. This direct control is called in Z-Wave association. For this purpose, the device ID of the device to be controlled must be stored in the controlling devices. This is done in so-called association groups. An association group is always linked to an event in the controlling device (pressing a key or triggering a sensor). When this event occurs, a control command - usually a BASIC SET - is sent to all devices stored in an association group.

The device supports the following association group:

Group Number	Maximum Devices	Transmitted Content
Group 1	5 (0x05)	When the state of Smart Plug (turn on or off the load) is changed: <ol style="list-style-type: none"> <li>1. Set Configuration parameter 3 to 0 (0x00): Do not send Basic Report</li> <li>2. Set Configuration parameter 3 to 1 (0x00): Send Basic Report</li> <li>3. Set Configuration parameter 3 to 2 (0x00): Send Basic Report only when Load condition is changed not by Z-WAVE Command, such as short pressing.</li> </ol> Sending Meter Report.

### 3.2. Overview Configuration Parameter

Z-Wave products can be used in the network immediately after inclusion. Through configuration settings, however, the behaviour of the device can be adapted even better to the requirements of the application and additional functions can be activated.

Parameter	Byte-size	Funktion	Default-Value (Decimal)	Description
1	1	Overvoltage protection	1	Enable / Disable overvoltage protection. <ul style="list-style-type: none"> <li>0 = Disabled</li> <li>1 = Enabled</li> </ul> (Hexadecimal: 0x00 – 0x01)
2	1	Device status after power failure	0	Set which device status should be present after a power failure. <ul style="list-style-type: none"> <li>0 = Status before power failure</li> <li>1 = Status "on"</li> <li>2 = Status "off"</li> </ul> (Hexadezimal: 0x00 – 0x02)
3	1	Device status report	1	Device status report when device status changes. <ul style="list-style-type: none"> <li>0 = Disabled</li> <li>1 = Send report</li> <li>2 = Send report only with manual change</li> </ul> (Hexadezimal: 0x00 – 0x02)
4	1	LED indicator	0	Behaviour of the LED display with device status "On". <ul style="list-style-type: none"> <li>0 = LED is permanently active with device status "On"</li> <li>1 = LED is active for 5 seconds when changing to device status "On" and then extinguishes</li> </ul> (Hexadezimal: 0x00 – 0x01)
16	2	Power report (Threshold)	50	The threshold value serves as an additional condition for the time-based report. If the threshold value was not exceeded, the time-based report is not sent. The value 0 deactivates the power report threshold. <ul style="list-style-type: none"> <li>Adjustable from 0 – 65535 in Watt</li> </ul> (Hexadecimal: 0x00 – 0xFFFF)

17	1	Power report (Threshold value in percent)	10	<p>The threshold value serves as an additional condition for the time-based report. If the threshold value was not exceeded, the time-based report is not sent. The value 0 deactivates the power report threshold.</p> <ul style="list-style-type: none"> <li>Adjustable from 0 – 127 in Watt (Hexadecimal: 0x00 – 0x7F)</li> </ul>
100	1	Reset 101 – 104	-	<ul style="list-style-type: none"> <li>84 = Resets parameter 101 - 104 to factory setting.</li> </ul>
101	4	Power report (Time)	600	<p>The interval time of the power report (W). The value 0 disables the report.</p> <ul style="list-style-type: none"> <li>Adjustable from 5 - 2678400 in seconds (Hexadecimal: 0x00 - 0x28DE80)</li> </ul>
102	4	Consumption report (Time)	3600	<p>The interval time of the consumption report (kWh). The value 0 disables the report.</p> <ul style="list-style-type: none"> <li>Adjustable from 5 - 2678400 in seconds (Hexadecimal: 0x00 - 0x28DE80)</li> </ul>
103	4	Voltage report (Time)	0	<p>The interval time of the voltage report (V). The value 0 disables the report.</p> <ul style="list-style-type: none"> <li>Adjustable from 5 - 2678400 in seconds (Hexadecimal: 0x00 - 0x28DE80)</li> </ul>
104	4	Current report (Time)	0	<p>The interval time of the current report (A). The value 0 disables the report.</p> <ul style="list-style-type: none"> <li>Adjustable from 5 - 2678400 in seconds (Hexadecimal: 0x00 - 0x28DE80)</li> </ul>
254	1	Enable / Disable Configuration	0	<p>Enables / Disables the configuration.</p> <ul style="list-style-type: none"> <li>0 = Configuration is enabled</li> <li>1 = Configuration is disabled</li> </ul> <p>(Hexadecimal: 0x00 - 0x01)</p>

### 3.3. Command Classes

**Supported:**

1. Association Group Information V1
2. Association V2
3. Basic V1
4. Binary Switch V1
5. Configuration V1
6. Device Reset Local V1
7. Firmware Update MD V4
8. Manufacturer Specific V2
9. Meter V3
10. Power level
11. Scene Activation
12. Scene Actuator Configuration
13. Security S2
14. Security V1
15. Supervision
16. Transport Service V2
17. Version V2
18. Z-Wave Plus Info V2

#### 4. Technical Specifications

Parameters	Unit	SHHA10000
Dimensions	mm	45 x 45 x 70
Weight	g	65
Operating Temperature	°C	0 – 25
Max. Humidity	%	90
IP Class		20
Radio frequency	MHz	868,42 (Z-Wave PLUS, Europe)
Material		ABS, polished
Power Supply		220 – 240 V
Power consumption	W	1
Measuring range / tolerance	V	220 – 240 / 1
Measuring range / tolerance	A	< 10A / 0,1
Measuring range / tolerance	W	< 2300W / 1
Maximum Load		2300W (10A/240VAC)
Max. Range (open field)	m	100
Max. Range (Building)	m	20, related to material of walls
Tamper protection		No
Firmware updateable		Yes
Support Z-Wave Beaming		Yes
SmartStart supported		No
Z-Wave Network Security		Yes
Z-Wave AES-128 Security		No
Z-Wave Plus		Yes
Security S2 Classes		Yes
Z-Wave Chip Generation		500
Z-Wave Sensor-Typ		Enhanced 232 slave
Zwave library type		On/off power switch /
Always on slave		