



Security Tech Germany

# SHSG10000 ABUS Z-Wave Siren



Important information and FAQs about this product and other products can be found on the website

[www.abus.com](http://www.abus.com)

Version 1.4

*Original operating instructions in English.  
Keep for future use!*



## Introduction

Dear customer,

We are pleased that you have chosen our product and thank you for your trust! You made a good choice.

This Siren (hereinafter referred to as the "device") has been developed and manufactured with the utmost care. Please read these operating instructions completely and observe all operating and safety instructions, as this ensures the best possible handling of the device. This document is an installation and maintenance manual.

**If you have any questions, please contact your specialist trade partner  
or contact our customer service:**

**Mail: ABUS Support, Linker Kreuthweg 5, 86444 Affing, Germany**

**E-mail: [support@abus-sc.com](mailto:support@abus-sc.com)**

**Phone: +49 8207 959 90 888**

**Hotline opening hours: Mon-Thu: 08 - 17 h; Fri: 08 - 14 h**

**ABUS Security-Center hereby declares that the enclosed product comply with the requirements of the following directives**

RED Directive (2014/53/EU), EMC Directive (2014/30/EU), Low Voltage Directive (2014/35/EU) and RoHS Directive (2011/65/EU). The full EU Declaration of Conformity text can be found at:

[www.abus.com/product/SHSG10000](http://www.abus.com/product/SHSG10000)

It can also be obtained at the following adress:

**ABUS Security-Center GmbH & Co. KG,  
Linker Kreuthweg 5, 86444 Affing, GERMANY**

All contained company names and product designations are trademarks of the respective owners. All rights reserved.



### Disclaimer of Liability

These operating instructions have been prepared with the greatest care. Should you nevertheless notice omissions or inaccuracies, please inform us in writing at the above address.

Your rights are limited to the repair or replacement of this product as delivered. ABUS Security Center assumes no liability for any special, incidental or consequential damages, including but not limited to loss of revenue, loss of profit, restrictions in the use of the software, loss or recovery of data, costs for replacement equipment, downtime, property damage and claims of third parties, as a result of and in connection with the use of the software. a. warranty, contractual, legal or claims for damages notwithstanding other limited or implied warranty provisions or in the event that the limited warranty does not apply, the scope of liability of ABUS Security Center is limited to the purchase price of the product.

The contents of this manual are subject to change without notice.

© ABUS Security-Center GmbH & Co. KG, 09/2018

## Important Safety Informations

### Intended Use

Only use the device for the purpose for which it was built and designed. Any other use is considered unintended.

**All guarantee claims are invalid in the event of damage caused by non-compliance with this safety information. We cannot be held liable for resulting damage.**

### Unboxing

Handle the device with extreme care when unpacking it.

Packaging and packaging aids can be reused and, as far as possible, should be sent for recycling.

**If the original packaging has been damaged, inspect the device first. If the device shows signs of damage, return it in the original packaging and inform the delivery service.**

### Installation location / operating environment

Do not place any heavy objects on the device. The device is only designed for operation in spaces with appropriate temperatures or humidity (e.g. not for bathrooms). Do also not place the device in areas with excessive accumulation of dust. Please refer to the individual devices' technical data for more detailed information. Ensure that: adequate ventilation is always guaranteed; no direct sources of heat can affect the device; interior devices are not exposed to direct sunlight or strong artificial light; the device is not in the immediate vicinity of magnetic fields (e.g. loudspeakers); no naked flames (e.g. lit candles) are placed on or next to the device; sprayed or dripping water is prevented from coming into contact with interior devices and caustic fluids are avoided; the device is not operated in the vicinity of water, in particular, the device should never be submerged (do not place objects containing fluids, e.g. vases or drinks, on or near the device); no foreign bodies penetrate the device; the device is not exposed to wide temperature variations, as otherwise there may be condensation from humidity causing electrical short circuits; the device is not exposed to excessive shock or vibration.

### Children

Keep electrical devices out of reach of children. Never allow children to use electrical devices unsupervised. Children may not always properly identify possible hazards. Small parts may be fatal if swallowed. Keep packaging film away from children. There is a risk of suffocation. This device is not intended for children. If used incorrectly, parts under spring tension may fly out and cause injury to children (e.g. to eyes).

### Information on handling batteries

- Make sure that batteries are kept away from small children. Children may put batteries in their mouths and swallow them. This can cause serious harm to their health. If this happens, consult a doctor immediately.
- Do not charge normal batteries, heat them up or throw them into naked flames (they may explode).
- The battery must not be directly exposed to heat or sunlight, and must not be stored in a place with a very high temperature.
- The battery must not come into contact with water.
- The battery must not be dismantled, pierced or otherwise damaged.
- The battery contacts must not be short-circuited.
- Change low batteries in good time.
- Always change all the batteries at the same time and use batteries of the same type.
- Leaky or damaged batteries can cause chemical burns on contact with the skin. In this case, wear protective gloves. Clean the battery compartment with a dry cloth.

### Important information on battery disposal



Batteries with this label do not contain harmful substances such as cadmium, lead and mercury. However, used batteries must not be disposed of along with household waste in accordance with the battery directive. To protect natural resources and promote the recycling of materials, separate the batteries from other waste and deposit them at a local recycling center. An additional label with the chemical symbols for Hg, Cd or Pb means that the batteries contain quantities of mercury, cadmium or lead which exceed the restrictions set by the EU Directive 2006/66/EG. If batteries are not disposed of properly, these substances can cause harm to human health or the environment

### Cleaning

- Dusty devices must be cleaned. You can clean dust from the air vents using a vacuum cleaner or compressed air. If necessary, you can remove the dust with a brush.
- You can clean the surface using a cloth slightly dampened in soapy water. Only use suitable microfiber cloths for high-gloss surfaces.
- Do not allow water to penetrate the device.
- Do not clean the device in a dishwasher.
- Do not use sharp, pointed, abrasive or corrosive cleaning materials or hard brushes.
- Do not use chemicals.
- Do not use flammable liquids for cleaning the device.

### Information on device disposal



Important: The EU Directive 2012/19/EU regulates the proper return, treatment and recycling of used electronic devices. This symbol means that in the interest of environmental protection the device must be disposed of separately from household or industrial waste at the end of its service life in accordance with applicable local legal guidelines. Disposing of used devices can be done at official recycling centers in your country. Obey local regulations when disposing of material. Further details on returns (also for non-European countries) can be obtained at your local authority. Separate collection and recycling saves natural resources and ensures that all the provisions for protecting health and environment are observed when recycling the product.

## Table of contents

1. Product introduction .....	6
1.1. Scope of Delivery.....	6
1.2. Device features.....	6
1.3. Operating principle .....	6
1.4. Performance Features .....	7
1.5. Use in systems of different manufacturers .....	7
2. Overview of functions .....	8
2.1. Inclusion / Add Device .....	8
2.2. Exclusion / Remove Device.....	9
2.3. Reset (Factory-Reset) .....	9
3. Advanced Z-Wave Parameter .....	10
3.1. Association Group Information .....	10
3.2. Command Classes .....	10
4. Technical Specifications.....	11

## 1. Product introduction

### 1.1. Scope of Delivery

- ABUS Z-Wave Siren
- Quickguide & Safety instructions

### 1.2. Device features

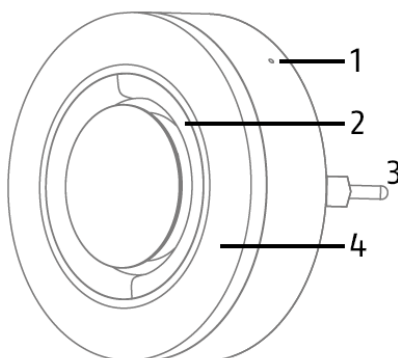

Nr	Label	Comment
1	Netzwerk-Taste	Zur Inklusion / Exklusion des Melders in ein Z-Wave Gateway, Werks-Reset
2	Lautsprecher	Im Alarmfall ertönt hier ein 95dB lauter Signalton
3	Stromstecker	Zum Anschluss in der Steckdose
4	Blitzlicht	Im Alarmfall leuchtet der Ring rot auf

### 1.3. Operating principle

The SHSG10000 was developed for use in home automation systems that use the Z-Wave wireless standard. The siren serves as an alarm device and is equipped with a loud siren (up to 95 dB) and a red LED flash. Thanks to the integrated backup battery, the siren can still alert for up to 5 minutes or operate in standby mode for approx. 4 hours, even when removed from the power supply.

The switching interval must not be below 30 seconds!

#### **1.4. Performance Features**

The ABUS Z-Wave SHSG10000...:

- ... is an radio siren with integrated backup battery
- ... is Z-Wave PLUS compatible & certified
- ... supports the Z-Wave S2 Standard (Security 2)
- ... alarms loudly by the integrated 95dB siren
- ... has a red LED flash which lights up in case of alarm
- ... was developed for indoor use

#### **1.5. Use in systems of different manufacturers**

Communication is via the Z-Wave EU frequency (868.42 Mhz). You can integrate the device into any Z-Wave network with a certified Z-Wave gateway, regardless of manufacturer. All non-battery powered nodes in the network act as repeater to increase the durability of the network.

## 2. Overview of functions

### 2.1. Inclusion / Add Device

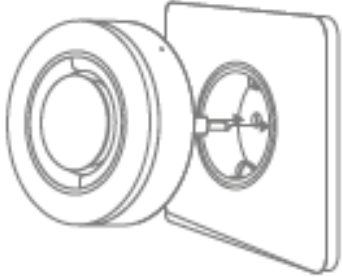

Plug the device into a socket.

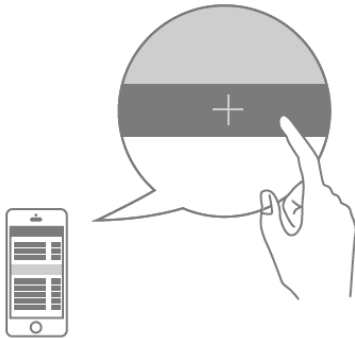

Click the + (Add) button in your Z-Wave App and follow the further instructions

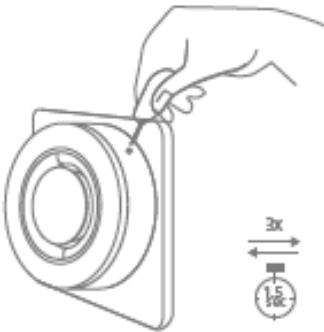

Press the Network-button 3 times within 1.5 seconds and the Status-LED will flash 3 times

If the Add device process is successful, the Status-LED will turn off.

Repeat the inclusion process from if it was not successful.



## 2.2. Exclusion / Remove Device

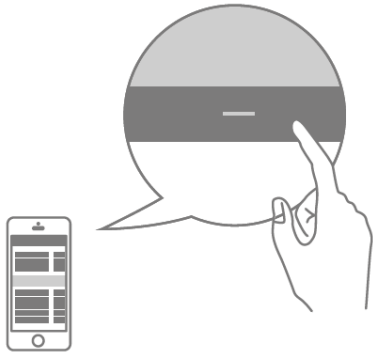

Click the - (Remove) button in your Z-Wave App and follow the further instructions

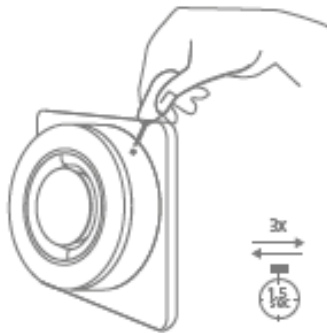

Press the Network-button 3 times within 1.5 seconds and the Status-LED will flash 3 times

If the Remove device process is successful, the Status-LED flash 6 times.

Repeat the exclusion process if it was not successful.

## 2.3. Reset (Factory-Reset)

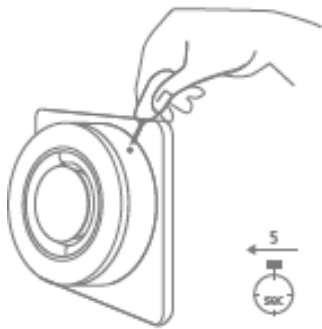

Press and hold the network button for 5 seconds.

The device is now restored to factory settings

### **Note:**

This procedure should only be used if the primary gateway is not capable of acting.

If the device is set to the factory setting, the status is set to "not included", the association settings and possible configurations are reset to default.

### 3. Advanced Z-Wave Parameter

#### 3.1. Association Group Information

Z-Wave devices can control other devices directly. This direct control is called in Z-Wave association. For this purpose, the device ID of the device to be controlled must be stored in the controlling devices. This is done in so-called association groups. An association group is always linked to an event in the controlling device (pressing a key or triggering a sensor). When this event occurs, a control command - usually a BASIC SET - is sent to all devices stored in an association group.

The device supports the following association group:

Group Number	Maximum Devices	Transmitted Content
Group 1	5 (0x05)	Lifeline association group Include command classe: Battery report, Notification report, and Device Reset Locally notification, Binary report.

#### 3.2. Command Classes

1. Z-Wave plus InfoVersion 2
2. Switch Binary Version 1
3. Association Version 2
4. Association Group Info Version 1
5. Transport Service Version 2
6. Version Version 3
7. Manufacturer Specific Version 2
8. Device Reset Locally Version 1
9. Powerlevel Version 1
10. Security 2 Version 1
11. Supervision Version 1
12. Basic Version2

#### 4. Technical Specifications

Parameters	Unit	SHSG10000
Dimensions (Ø x D)	mm	80 x 80
Weight	g	122
Operating Temperature	°C	0 – 40
Max. Humidity	%	95
IP Class		20
Radio frequency	MHz	868,42 (Z-Wave PLUS, Europe)
Modulation		FSK/GFSK
Material		ABS
Transmission power	db	< 4,5
Power supply		110 – 240 V AC
Backup-Battery		3.8 V / 700 mAh / Lithium
Power consumption standby	W	2
Power consumption alarm	W	3
Battery-life		4 hours or 5 minutes in case of emergency
Alarm volume	dB	95 @ 1m
Range (open field)	m	100
Range (building)	m	20, related to material of walls
Tamper protection		No
Firmware updateable		No
Support Z-Wave Beaming		No
SmartStart unterstützt		No
Z-Wave Network Security		Yes
Z-Wave AES-128 Security		Yes
Z-Wave Plus		Yes
Security S2 Classes		Yes
Z-Wave Chip Generation		500